

The Lenovo logo, consisting of the word "Lenovo" in white sans-serif font on a yellow rectangular background.

Lenovo Tab P12

User Guide

TB370FU

Contents

| | |
|--|----|
| Welcome | 1 |
| Basics | 2 |
| Set up and get started | 2 |
| Prepare for setup | 2 |
| Initial setup | 2 |
| Learn about gestures | 4 |
| Basic gestures | 4 |
| More gestures | 5 |
| Customize your home screen | 6 |
| Home settings | 6 |
| Widgets | 7 |
| Wallpaper | 7 |
| Use your apps | 8 |
| Search for an app | 8 |
| Move an app to another screen | 8 |
| Manage the open apps | 8 |
| Uninstall an app | 8 |
| Entertainment Space | 9 |
| Open the Entertainment Space | 9 |
| Disable the Entertainment Space | 9 |
| Notifications and Quick settings | 9 |
| Control center style | 9 |
| Notifications panel | 9 |
| Quick settings panel | 10 |
| Factory reset, update and force shutdown | 10 |
| Factory reset | 10 |
| System update | 10 |

| | |
|---|-----------|
| Force shutdown..... | 11 |
| Settings | 12 |
| WLAN | 12 |
| VPN..... | 12 |
| Bluetooth..... | 12 |
| Display..... | 13 |
| Brightness..... | 13 |
| Reading mode..... | 13 |
| Eye protection and safety information | 13 |
| Biometrics and Passwords | 14 |
| One Vision..... | 14 |
| Floating Window | 14 |
| Split Screen | 14 |
| Digital Wellbeing & parental controls | 16 |
| Digital Wellbeing..... | 16 |
| Parental controls..... | 17 |
| Keyboard | 17 |
| Battery..... | 17 |
| Battery Saver..... | 18 |
| Charge optimization..... | 18 |
| Show battery power meter..... | 18 |
| Detect battery drain | 18 |
| Permission management..... | 18 |
| Language | 19 |
| Apps | 20 |
| Camera | 20 |
| Open Camera | 20 |
| Camera settings | 20 |
| Switch camera modes..... | 21 |
| View photos and videos..... | 21 |

| | |
|--------------------------------------|-----------|
| Files | 21 |
| Browse files | 22 |
| Clean files | 22 |
| Share files | 22 |
| Google apps..... | 22 |
| Advanced features..... | 23 |
| Lenovo Freestyle..... | 23 |
| Prepare for setup..... | 23 |
| Enable Lenovo Freestyle | 23 |
| Tablet projection to computer..... | 23 |
| Computer projection to tablet | 24 |
| File share..... | 24 |
| Multiple users..... | 24 |
| Multi-User Preferences | 24 |
| Creating new user accounts..... | 24 |
| Switching between user accounts..... | 25 |
| Deleting a user account | 25 |
| Global video beauty..... | 25 |
| Video portrait | 25 |
| Key Mapping | 26 |
| Lenovo Tab Pen Plus (optional) | 26 |
| Overview | 26 |
| Pair with a tablet..... | 27 |
| Pen settings | 27 |
| Notepad..... | 28 |
| Create a note..... | 28 |
| Manage a note | 28 |
| Edit a note | 28 |
| Use the pen | 29 |
| Delete a note | 30 |

| | |
|--|----|
| Appendix | 31 |
| Important safety and handling information | 31 |
| Electronic emission notices | 35 |
| Environmental, recycling, and disposal information | 37 |
| ENERGY STAR model information..... | 39 |
| Export classification notice..... | 40 |
| Dolby certification | 41 |
| HEVC Standard..... | 41 |

Welcome



Before using your device, be sure to read the following:

- *Quick Start Guide*
- *Safety and Warranty Guide*
- *Regulatory Notice*

To get more information and download the above documents, please go to <https://support.lenovo.com>.

 All pictures and illustrations in this guide are for your reference only. The actual product may vary.

Icons

-  Instruction, reminder, or suggestion.
-  Attention or caution.
-  Danger or warning.

Basics

Set up and get started

Prepare for setup

To make setup as smooth as possible, please prepare the following:

- An internet connection through a Wi-Fi network or a mobile network.
You may need the name and password of the Wi-Fi network.
- Your previous device or a backup of your device, if you're transferring your data to your new device.

Initial setup

This device has an easy setup process to help you get going when you first turn on your device. You can follow the onscreen setup instructions manually.

 After the initial setup, additional changes can be made in **Settings**.

1. Press and hold the Power button until you see the Lenovo logo. You will see **Hi there** on the screen.
 - **Select your language**: Tap and select your language from the language list.
 - **Vision settings**: Tap  to customize the size of the display and text, and enable **Magnification** to improve screen visibility. Enable **Select to Speak** or **TalkBack** to make your device easier to use without the screen.
2. Tap **Start**.
3. Read and accept the service agreements, then tap **Next**.
4. Connect to Wi-Fi network or mobile network (if your device supports it).
 - Tap a network, and enter a password if required.
 - Tap **Add new network**, then type a Wi-Fi network name manually and enter a password if required.

 If you set up offline, you need to manually set the time and date in the next step.

5. Transfer apps and data from your previous device to the new device.

You can transfer many of your apps, settings, and content from your previous device directly to your new device.

Bring the two devices close together, then follow the onscreen instructions.

6. Sign in to Google account and manage Google services.

7. Check privacy settings.

8. Select one of the following screen unlock methods to increase your device security. Follow the onscreen instructions to set a screen unlock method.

- **Password**
- **Fingerprint**
- **Face-recognition**

 Before enabling face-recognition, you need to create a pattern, PIN, or password. You can also tap **Skip** to set up later in **Settings > Biometrics and Passwords**.



9. Select your preferred navigation mode.

- **Gesture Navigation**

Operate your device by gestures. Refer to “**Learn about gestures**” for details.

- **Virtual Navigation**

Three buttons will appear on the navigation bar at the bottom of the screen.

| Button | Description |
|---|---|
|  | <ul style="list-style-type: none">• Go back Returning to the previous menu or exiting an app. |
|  | <ul style="list-style-type: none">• Home Returning to the home screen. |
|  | <ul style="list-style-type: none">• Switch apps Viewing the open apps. |

10. Tap **Get started**, you can get started on your device.

Learn about gestures

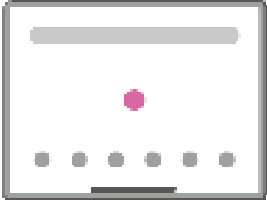
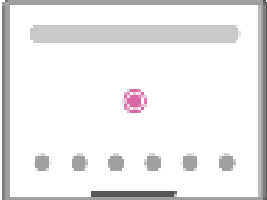
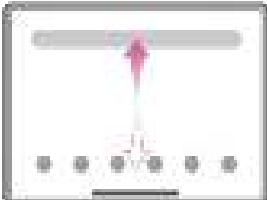
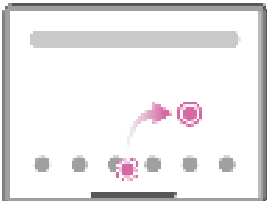
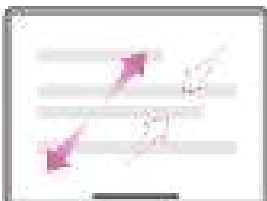

Your device supports **Gesture navigation** and **Virtual key navigation**.

Basic gestures

| | |
|--|--|
|  A diagram of a smartphone home screen with a dock at the bottom. A red dot is positioned over one of the icons in the dock, representing a tap gesture. | <p>Tap</p> <ul style="list-style-type: none">• Selecting or opening an item. |
|  A diagram of a smartphone home screen with a dock at the bottom. A red dot is positioned over one of the icons in the dock, representing a press and hold gesture. | <p>Press and hold</p> <ul style="list-style-type: none">• Accessing frequently used functions of the app.• Customizing your home screen. |
|  A diagram of a smartphone home screen with a dock at the bottom. A red arrow points upwards from the dock area, representing a swipe gesture. | <p>Swipe</p> <ul style="list-style-type: none">• Swiping up to open the list of all apps.• Swiping down to open the Notifications panel.• Swiping down twice to open the Quick settings panel. |
|  A diagram of a smartphone home screen with a dock at the bottom. A red arrow points from one icon in the dock to another, representing a hold and drag gesture. | <p>Hold and drag</p> <ul style="list-style-type: none">• Moving an app to where you want to place it. |
|  A diagram of a smartphone home screen with a dock at the bottom. A red arrow points from the center of the screen outwards, representing a spread gesture. Another red arrow points from the center of the screen inwards, representing a pinch gesture. | <p>Spread and pinch</p> <ul style="list-style-type: none">• Zooming in and out on websites, photos, maps, or other items. |

More gestures

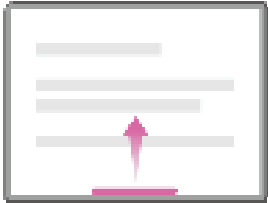

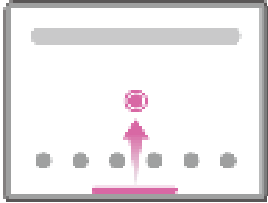
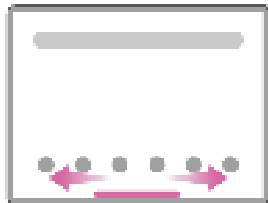
The following gestures are only available for the **Gesture navigation** style. To change the navigation style, go to **Settings > General settings > System navigation**.

| | |
|---|---|
|  | <p>Swipe up from the bottom edge.</p> <ul style="list-style-type: none">• Returning to the home screen. |
|  | <p>Swipe from the left or right edge.</p> <ul style="list-style-type: none">• Switching to the previous page. |
|  | <p>Swipe up from the bottom edge and hold.</p> <ul style="list-style-type: none">• Viewing the open apps. |
|  | <p>Swipe left or right at the bottom edge.</p> <ul style="list-style-type: none">• Switching between open apps. |

Customize your home screen

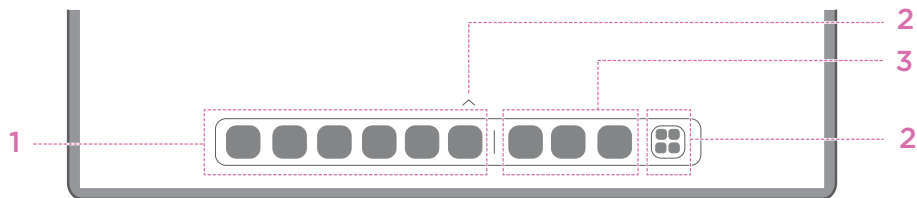
The home screen is the starting point for using your device. For your convenience, the home screen is already set up with some useful apps and widgets.



| No. | Function | Description |
|-----|---------------------------------|--|
| 1 | Taskbar | Add apps to the taskbar. |
| 2 | All applications | <ul style="list-style-type: none">• : Swipe up to view all apps.• : Tap to view all apps. |
| 3 | Most recently used applications | Display apps that have been used recently. |

You can customize your home screen in the following ways.

Home settings

Press and hold anywhere on the home screen except the icons, and tap **Home settings** to customize your device in the following ways.

- Swipe right to open Entertainment Space from the home screen.
- Select a preferred desktop style.
- Select a preferred home screen layout.
- Show notification dots on app icons.
- Show tips near the app name after updating.
- Recommend system apps in drawer.

Widgets

You can add a widget on your home screen. Widgets provide you with quick-views of the calendar events information, mails, maps, and more.

1. Press and hold anywhere on the home screen except the icons, tap **Widgets**, and select a widget you want to add.
2. Press and drag the widget to where you want to place it.
3. Tap **Done**.

Wallpaper

To set your wallpaper, do the following:

1. Press and hold anywhere on the home screen except the icons, tap **Personal customization > Wallpaper**.
2. Select to set wallpaper.
 - **Dynamic wallpaper**
Select an available dynamic wallpaper.
 - **Local albums**
Select a photo. Tap  > **Use as** to set it as your wallpaper.
 - **Battery wallpaper**
Set a Battery wallpaper on the lock screen displaying the power status: Full, Average, Low, or Charging.
 - **Exquisite wallpaper**
Select an available high quality wallpaper for the screen and/or desktop.

 You can also go to **Settings > Personal customization > Wallpaper** to set your wallpaper.

Use your apps

Search for an app

1. Tap  on the home screen or swipe up from the home screen to see a list of all apps.
2. Find an app directly or enter keywords in the search bar to search for an app.

Move an app to another screen

Press and hold the app that you want to move, drag it to where you want to place it, and then release it.

Manage the open apps

1. View a list of open apps using either of the following ways:
 - **Gesture navigation:** Swipe up from the bottom of the screen and hold.
 - **Virtual key navigation:** Tap  at the bottom of the screen.
2. On the open app list screen, you can do the following:
 - Tap an app window to access the app.
 - Swipe an app window up to close the app.
 - Swipe an app window down to lock or unlock the app.
 - Press and hold an app window to view more actions.
 - Tap **Clear all** to stop all the apps.

Uninstall an app

1. Press and hold an app icon.
2. Tap .
3. Tap **OK**.

 Some system apps are required by the device and cannot be uninstalled.

Entertainment Space

Entertainment Space is a one-stop, personalized screen for all your favorite movies, shows, videos, games, and books.

Open the Entertainment Space

Swipe right from the home screen or tap  on the left side of the home screen.

 Internet connection and Google account sign-in are necessary for using the Entertainment Space.

Disable the Entertainment Space

Entertainment Space is enabled by default. Go to **Home settings** and disable **Swipe to access Entertainment Space**.

Notifications and Quick settings

Control center style

Go to **Settings** > **Notification and control center** > **Control Center style**, to set the style of the Notifications and Quick settings panels.





Notifications panel

The Notifications panel informs you of new messages, USB connections, activities in progress such as file downloading, and more.

- To see notifications, swipe down from the top of the screen.
- To close the Notifications panel, swipe up from the bottom of the screen.
- To dismiss a notification, swipe left or right across the notification.
- To dismiss all notifications, tap **Clear all** at the bottom of the Notifications panel.
- To manage notifications, tap **Manage** at the bottom of the Notifications panel, or go to **Settings** > **Notification and control center**.

Quick settings panel

The Quick settings panel provides quick access to device functions. Icons change colors when corresponding functions are enabled and disabled.

- To open the Quick settings panel, swipe down from the top of the screen twice.
- To close the Quick settings panel, swipe up from the bottom of the screen.
- To enable or disable a function, tap the function icon.
- Press and hold a function icon to open the function's setting screen (if provided).
- Tap  to switch accounts.
- Tap  to edit the Quick settings panel.
- Tap  to open **Settings**.
- Tap  to power off or restart your device.

Factory reset, update and force shutdown

Factory reset

Factory reset will erase all data from your device's internal storage. Please back up important data on the device before resetting your device.

1. Go to **Settings** > **General settings** > **Reset options** > **Erase all data (factory reset)**.
2. Tap **Erase all data** to reset the manufacturer's default settings.

System update

Your device will prompt you to download and install updates when a new system version is available. You can also manually check for updates and set update methods.

1. Go to **Settings** > **About tablet** > **System Update**, and tap **Check for updates**.
2. Tap  at the top right of the **System Update** screen to enable or disable the automatic download and overnight upgrade features as needed.

 Download and install system updates from official sources only.

Force shutdown

Press and hold the Power and Volume down buttons for about 8 seconds until the device turns off.

Settings

WLAN



Connecting to the internet over a WLAN network is an effective method to save your mobile data.

1. Go to **Settings** > **WLAN**, and turn on **WLAN** to display a list of available networks.
2. Tap a network, and enter a password if required.
3. Tap **Connect**.

After the device is connected to a WLAN network,  will be displayed at the top of the screen.

VPN

VPNs are used within organizations to allow you to communicate private information securely over a non-private network. You may need to configure a VPN, for example, to access your work email. Ask the network administrator for the settings necessary to configure a VPN for your network.

1. Go to **Settings** > **More Connections** > **VPN**.
2. Tap  to edit the VPN profile.
3. Tap **Save**.
4. Tap  to edit or forget the VPN.

Bluetooth

You can pair your device to other Bluetooth-enabled devices, like Bluetooth headphones.

1. Go to **Settings** > **Bluetooth**, and enable **Bluetooth**.

2. Select a device name to match and connect.

After the device is connected to a Bluetooth device,  will be displayed at the top of the screen.

Display

Brightness

- **Manual adjustment**

Go to **Settings** > **Display**, and move the Brightness slider to adjust the screen brightness manually.

- **Automatic adjustment**

Go to **Settings** > **Display**, and enable **Adaptive brightness** to allow the screen to change brightness as lighting changes automatically.

Reading mode

1. Go to **Settings** > **Display** > **Reading mode**, and turn on **Reading mode**.
2. Select a reading mode display effect.

Eye protection and safety information

When **Night Light** is enabled, the screen will have an amber tint, which reduces blue light. This allows you to read or view the screen more comfortably in dimly lit environments.

1. Go to **Settings** > **Display** > **Night Light**, and enable **Use Night Light**.
2. Tap **Turns on at custom time** to customize your eye protection mode time.
3. Slide the Intensity slider to adjust the light as needed.

Please use the device in a well-lit area, and when using the device, keep it at a suitable distance from your eyes. To avoid eyestrain, take a break from looking at the screen after a period of time.

While concentrating on the performance capabilities of its screens, Lenovo also places importance on users' eye health. This product has received TÜV Rheinland's "Low Blue Light" certification and can be used with confidence. For further information, please visit <https://support.lenovo.com>.

Biometrics and Passwords

Setting a lock screen is an effective way to increase device security.





1. Go to **Settings > Biometrics and Passwords**.
2. To set screen lock, do any of the following:
 - **Passwords**
Select Pattern, PIN or Password to increase your device security.
 - **Fingerprint**
Place your finger on the sensor on the power button to set Fingerprint.
 - **Facial recognition**
Face-recognition is set in combination with the pattern, PIN, or password as an alternate screen unlock method.
3. Follow the onscreen instructions to set up your device.

One Vision

Floating Window

The Floating window feature is used for handling temporary tasks without having to switch between apps.

To open Floating Window, do one of the following:

- Press and hold an app icon, then tap .
 - Open an app. At the bottom of the app, press and drag the page to  at the top of the screen, then release the page.
 - Open an app, then tap **⋮ >** .
-  Go to **Settings > One Vision > Floating Window** to view more gestures to operate floating window.

Split Screen

Split screen mode enables you to open apps in a split screen and use them at the same time.

Enable split screen mode

To open split screen, do one of the following:

- Method one:

1. In full-screen mode of the app, open the list of all apps.
2. Select the app you want to split, press and drag the app icon to the edge of the screen.

- Method two:

In full-screen mode of the app, tap  > .

- Method three:

1. Open the list of the open apps.
2. Press and hold an app window, and then tap .

 Not all applications support split screen mode.

Enable three or four split screens

1. In split screen mode (Two apps running on the same screen), open the list of all apps.
2. Select the third app you want to split, press and drag the app icon to the top or bottom of the split screen apps screen.
3. To add a fourth split screen, repeat step two.

Manage the split screen

In split screen mode, you can do the following:

- **Adjust the split screen size**

Slide the  in the middle of the screens to adjust the split screen size.



- **Replace the second app**

Press and drag the app to the edge of the screen until the screen color turns grey.

- **Switch split screen to floating window**

Tap  at the top of the app and then tap .

Exit split screen mode

- Slide the  to the edge of the screen.
- Tap  at the top of the app and then tap .

Digital Wellbeing & parental controls

With **Digital Wellbeing & parental controls**, you can access real-time reports showing how much time you spend on your device. You can also set limits for what you want to manage.

Go to **Settings > Digital Wellbeing & parental controls**, and then set the related functions.

Digital Wellbeing

- **Dashboard**
 - View your screen time, notifications received and times opened.
 - Set daily timers for most apps.
- **Bedtime mode**
 - Customize the start and end times of bedtime mode.
 - Set the time period during which the device will automatically activate Bedtime mode while charging.

- **Focus mode**

Select distracting apps, then tap **TURN ON NOW** to pause distracting apps and hide their notifications.

- **Manage notifications**

Disable or enable notifications for specific apps.

- **Do Not Disturb**

Block notifications and avoid interruption when you need to concentrate.

- **Heads Up**

Remind you to stop using your phone while walking.

- **Show icon in the app list**

Display the digital wellbeing icon in the list of all apps.

Parental controls

- Tap **Set up parental controls** and follow the on screen instructions. You can connect your parent's device or your child's device using Google Family Link.
- After connecting the devices, a parent can manage mature content, website access, location services, and other settings on a child's device.

Keyboard

You can work more efficiently by using a keyboard. To view more features, go to **Settings > Pen and keyboard > Physical keyboard**.

- **Keyboard layouts**

To modify the default keyboard layout, go to **Settings > Pen and keyboard > Physical keyboard**, then tap the name of the keyboard.

- **Use on-screen keyboard**

Keep virtual keyboard on screen while physical keyboard is active.

- **Keyboard shortcuts**

Keyboard shortcuts are available for performing functions quickly. Go to **Settings > Pen and keyboard > Physical keyboard > Keyboard shortcuts** to view all keyboard shortcuts.

 Press and hold Ctrl for 3 seconds to view keyboard shortcuts at any time.

- **Touchpad Gestures**

Go to **Settings > Pen and keyboard > Physical keyboard > Multi-finger gestures** to view all Touchpad gestures.

Battery

Go to **Settings > Battery**, and you can check the battery usage and manage the battery.

Battery Saver

Reduce power consumption by limiting background activity, visual effects, certain features, and some network connections.

Charge optimization

Enable **Charging Protection** and **Battery Maintenance mode** to extend battery life.

Charging protection prevents charging for extended periods, which exposes the battery to high temperatures and high voltage that may cause it to age faster. When the mode is enabled, power will eventually be maintained at about 50% to extend battery life.

Show battery power meter

Show or hide the battery percentage in the status bar.

Detect battery drain

Smart detect the software and hardware that consume abnormal power.

Tap **One-key processing** to optimize battery consumption.

Permission management

Some apps may require your permission for location or privacy data access to provide corresponding services. To manage app permissions, do any of the following methods:

- **Manage an individual app's permissions**



Press and hold an app, tap ⓘ to go to **App info** > **Permissions**. Check the permissions granted or denied to the app, and tap to reset the permission.

- **Manage permissions by category**

- **Location:** Go to **Settings** > **Location**, check the apps that access location, and tap an app to reset the permission.
- **Privacy:** Go to **Settings** > **Privacy Protection** > **Permission manager**, select a capability, check the apps that access the capability, and tap an app to reset the permission.

Language

You can add frequently-used languages to your list and set your system language.

1. Go to **Settings > General settings > Languages & input > Languages**.
 2. Tap **Add a language** and select the language that you want to add.
 3. Tap **Change**.
-  Set the system language by dragging  to the top of the list.

Apps

Camera









Open Camera



Tap  on the home screen to open **Camera**.

 On some models, the app may not appear on the home screen. You can open the list of all apps and find the app.

Camera settings

Use the icons on the main camera screen and the settings menu to configure your camera's settings.

| Icon | Description |
|---|--|
|  | Recognize the text in the picture |
|  | Switch to front camera or rear camera |
|  | Take a photo |
|  | Select photo size |
|  | Set flash settings |
|  | Turn HDR on and off |
|  | Blur the background |
|  | Apply beauty effects |
|  | Select a filter and preview the effect |

| Icon | Description |
|---|--|
|  | Turn AI photo assistant on and off |
|  | Configure other camera settings |
|  | Record a video Tap Video to switch to the video mode before you can see this icon. |

Switch camera modes

- **Central Portrait**

Keep your face in the center of the frame automatically when recording.

- **Camera**

Take photos.

- **Video**

Record videos.

- **AI scan**

Position the document in view of the camera and tap . The scanned document can be saved as PDF or JPG.

View photos and videos

Photos and videos are stored in your device's internal storage. You can view your photos and videos by using the following methods.

- Tap the thumbnail when using the Camera app.
- Go to **Photos**.
- Go to **Files**.

Files

Open the list of all apps. Tap  to open **Files**. You can view and manage files stored on your device, including images, videos, audio, and more.

Browse files

Go to **Files** > **Browse**, and you can do the following:

- View recently stored files.
- View files by category.
- Tap **Internal storage** and view files by storage path.
- Tap  at the top right of the screen, and type in keywords to search for a file.

Clean files

Go to **Files** > **Clean**, check the internal storage space and clean junk files.

Share files

Go to **Files** > **Nearby Share**, and follow the onscreen prompts to quickly send or receive files.

Google apps

Google apps are preinstalled on your device. You can visit support.google.com to learn more about Google apps. The apps can be also obtained from Google Play Store.

Advanced features

Lenovo Freestyle

Lenovo Freestyle is used for collaboration between tablet and computer.

Prepare for setup

To make setup as smooth as possible, please prepare the following:

- Download and install the Freestyle app on your computer.
- Make sure your computer and tablet are on the same network.

Enable Lenovo Freestyle

1. Operation on the computer
 - a. Open the Lenovo Freestyle app.
 - b. Login using your Lenovo ID.
2. Operation on the tablet
 - a. Open the Quick settings panel, tap .
 - b. Log in with same Lenovo ID as your computer.
3. Tap the tablet name on the Lenovo Freestyle app on your computer. The tablet and computer are now connected.

Tablet projection to computer

To project the tablet apps to your computer, drag and drop the tablet app icon onto the computer name. You can then control apps on your tablet with your computer.

-  Some apps may not be projected on Windows due to compatibility issues.

Computer projection to tablet

You can mirror your computer screen on your tablet or turn your tablet into a second screen for your computer.

File share

- **Computer to tablet**

Select the file you want to send to your tablet on your computer, then follow the onscreen instructions.

- **Tablet to computer**

Select the file you want to share in Files on the tablet and choose Lenovo Freestyle for sharing.

 For more information about File share, refer to “**Files**”.

Multiple users



Multi-User Preferences

There are three user types:

- **Owner:** An owner has full control over all user permissions and manages all user accounts.
- **Guest:** There is only one guest account. A guest has restricted access to the device.
- **New User:** There can be multiple standard user accounts.

Creating new user accounts



Swipe down from the top right corner of the screen.

- Tap  > **Add user** to create a standard user account.
- Tap  > **Add guest** to create a guest account.

Or go to **Settings** > **General settings** > **Multiple users**.

- Tap **Add guest** to create a guest account.
- Tap **Add user**, and then enter User info to create a standard user account.

Switching between user accounts

- On the home screen, swipe down from the top right corner of the screen, and then tap  to switch between different user accounts.
- On the lock screen interface, tap , then select the user you want to switch to.
- Go to **Settings** > **General settings** > **Multiple users**, then select the user account you want to switch to.

Deleting a user account

Swipe down from the top right corner of the screen. Tap  > **MORE SETTINGS**, select the account you want to delete, then tap **Delete user** to delete accounts. You can also go to **Settings** > **General settings** > **Multiple users** to delete accounts.

Global video beauty

Global video beauty automatically improves your appearance when you are on a video call. Different backgrounds can also be set as needed.

Open the Quick settings panel, and then tap  to open Global video beauty.

Press and hold  to do the following:

- Enable **Video call beauty**.
- Move the Beauty slider to adjust the effect manually.
- Set One-touch cut to change the background behind you.

Video portrait

Video portrait tracking keeps your face at the center of the frame during a video call, no matter how far away the user is from the camera or even while moving.

Open the Quick settings panel, and tap  to open Video portrait.

 Video portrait only supports applications shown in the **Support Apps**.

Key Mapping

Key Mapping allows you to operate applications by using multiple peripherals such as a keyboard, mouse, and controller.

Go to **Settings** > **Advanced features** > **Key Mapping** and enable **Key Mapping**. You can use Bluetooth to connect to your mouse, keyboard or controller.

Lenovo Tab Pen Plus (optional)

The Lenovo Tab Pen Plus provides a better experience for writing or drawing on the screen.

Overview

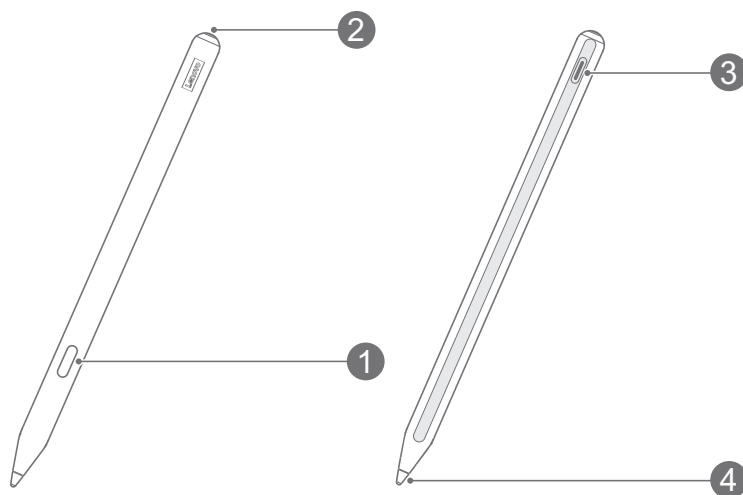

| | |
|---|-----------------|
| 1 | Button |
| 2 | LED indicator |
| 3 | USB-C connector |
| 4 | Tip |

Pair with a tablet

1. Go to **Settings** > **Bluetooth** and enable **Bluetooth** from the tablet's Settings screen.
2. Press and hold the pen button for 8 seconds to enter pairing mode.
3. Tap **Connect** > **Complete** on your tablet.









 Before the first use, charge the pen for pairing.

Pen settings

1. Go to **Settings** > **Pen and keyboard** > **Lenovo Pen** on the tablet's Settings screen.
2. Follow the onscreen instructions to set functions as needed.

- Stylus tool box

Display a Stylus tool box containing frequently used functions at the edge of the screen.

| Icon | Description |
|---|--|
|  | Start AI scan in camera |
|  | Take a screenshot |
|  | Create a note |
|  | Show the pen track  Only supports pen operation |
|  | Magnify the area you tap with the pen  Only supports pen operation |
|  | Enable the remote control |

- Handwrite

Use the pen to write within any text area and convert the content to text.

- Firmware update



Check the current version of the pen and manually check for updates.

Notepad

Use text, image, and voice recording features to quickly record your inspiration and ideas, boosting efficiency and making it easy to handle tasks.





Create a note

To create a note, do one of the following:

- Tap  to open the notepad. Then, tap  to create a new note.
- Go to **Settings** > **Pen and keyboard** > **Lenovo Pen**, enable **Stylus tool box**, and tap  to quickly create a new note.
- Go to **Settings** > **Pen and keyboard** > **Lenovo Pen**, enable **Quick notes**, and then press and hold the pen button while tapping the screen to create a new note.



Manage a note





Use the following icons on the notepad interface to manage your note.

| Icon | Description |
|---|----------------------------|
|  | Search for a note |
|  | Change the note list style |
|  | Configure notepad settings |
|  | Share a note |

Edit a note

After creating a note, use the following icons to edit your note.











| Icon | Description |
|---|-------------------|
|  | Undo operation |
|  | Restore operation |

| Icon | Description |
|---|-------------------------|
|  | Insert pictures |
|  | Insert checkboxes |
|  | Insert voice recordings |
|  | Edit a note |

 Tap the screen with your finger instead of the pen to display the above icons.

Use the pen

Enter pen editing mode and edit the content with the following icons.

| Icon | Description |
|---|-----------------------------------|
|  | Change the pen style |
|  | Erase the handwriting |
|  | Frame the handwriting |
|  | Intelligent shapes |
|  | Convert handwriting to text |
|  | Change the pen color |
|  | Undo |
|  | Restore |
|  | Switch to keyboard input |
|  | Enable or disable finger painting |

Delete a note

To delete a note, do one of the following:

- Press and hold on your note list, select the note you want to delete and tap **Delete**.
- Slide the selected note to the left and tap .

Appendix

Important safety and handling information

To avoid personal injury, property damage, or accidental damage to the product, read all of the information in this section before using the product. For additional tips to help you operate your device safely, go to <http://www.lenovo.com/safety>.

Handle your device with care

Do not drop, bend, or puncture your device; do not insert foreign objects into or place heavy objects on your device. Sensitive components inside might become damaged.

Your device screen is made of glass. The glass might break if the device is dropped on a hard surface, is subjected to a high impact, or is crushed by a heavy object. If the glass chips or cracks, do not touch the broken glass or attempt to remove it from the device. Stop using the device immediately and contact Lenovo technical support for repair, replacement, or disposal information.

When using your device, keep it away from hot or high-voltage environments, such as electrical appliances, electrical heating equipment, or electrical cooking equipment. Use your device only in the temperature range of 0°C (32°F) to 40°C (104°F) (storage -20°C (-4°F) to 60°C (140°F)) to avoid damage.

Don't expose your device to water, rain, extreme humidity, sweat or other liquids.

Do not disassemble or modify your device

Your device is a sealed unit. There are no end-user serviceable parts inside. All internal repairs must be done by a Lenovo-authorized repair facility or a Lenovo-authorized technician. Attempting to open or modify your device will void the warranty.

Built-in rechargeable battery notice

Do not attempt to replace the internal rechargeable lithium ion battery. There is a risk of explosion if the battery is replaced with an incorrect type. Contact Lenovo Support for replacement.

Plastic bag notice

DANGER

Plastic bags can be dangerous. Keep plastic bags away from babies and children to avoid danger of suffocation.

Adapter information

- Prevent your device and AC adapter from getting wet.

Do not immerse your device in water or leave your device in a location where it can come into contact with water or other liquids.

- Use approved charging methods only.

 Please only use standard Lenovo power adapters. The use of third-party power adapters will affect the charging speed, resulting in abnormal charging and potential damage to the equipment.

- Connect a standard power adapter to a suitable power outlet.
- Use a standard data cable to connect the device to a PC or a device that complies with USB 2.0 or higher.

Charging devices might become warm during normal use. Ensure that you have adequate ventilation around the charging device. Unplug the charging device if any of the following occurs:

- The charging device has been exposed to rain, liquid, or excessive moisture.
- The charging device shows signs of physical damage.
- You want to clean the charging device.

WARNING

Lenovo is not responsible for the performance or safety of products not manufactured or approved by Lenovo. Use only approved Lenovo ac adapters and batteries.

EU ErP (EcoDesign) Directive (2009/125/EC) - external power adapters (Regulation (EU) 2019/1782)

Ecodesign for Energy-Related Products Regulations 2010 - UK SI 2010 No. 2617 (Ext PSU), SI 2020 No. 485 (Ntwk Standby), SI 2014 No. 1290 as amended

Lenovo products are in compliance with the EU EcoDesign (ErP) Directive & UK EcoDesign for Energy-related Products Regulations. Refer to the following for details:

For EU, refer to the system declaration <https://www.lenovo.com/us/en/compliance/eu-doc>, and for UK refer to the system declaration <https://www.lenovo.com/us/en/compliance/uk-doc>.

Caution about high volume usage

WARNING

Exposure to loud noise from any source for extended periods of time may affect your hearing. The louder the sound, the less time is required before your hearing could be affected.

To protect your hearing:

- Limit the amount of time you use headsets or headphones at high volume.
- Avoid turning up the volume to block out noisy surroundings.
- Turn the volume down if you can't hear people speaking near you.

If you experience hearing discomfort, including the sensation of pressure or fullness in your ears, ringing in your ears or muffled speech, you should stop listening to the device through your headset or headphones and have your hearing checked.



To prevent possible hearing damage, do not listen at high volume levels for long periods.

Take care when using your device in a motor vehicle or on a bicycle

Always prioritize your safety and the safety of others. Follow the law. Local laws and regulations might govern how you can use mobile electronic devices, such as your device, while you drive a motor vehicle or ride a bicycle.

Dispose according to local laws and regulations

When your device reaches the end of its useful life, do not crush, incinerate, immerse in water, or dispose of your device in any manner contrary to local laws and regulations. Some internal parts contain substances that can explode, leak, or have adverse environmental effects if disposed of incorrectly.

See “Environmental, recycling, and disposal information” for additional information.

Keep your device and accessories away from small children

Your device contains small parts that can be a choking hazard to small children. Additionally, the glass screen can break or crack if dropped on or thrown against a hard surface.

Protect your data and software

Do not delete unknown files or change the name of files or directories that were not created by you. Otherwise, your device software might fail to work.

Be aware that accessing network resources can leave your device vulnerable to computer viruses, hackers, spyware, and other malicious activities that might damage your device, software, or data. It is your responsibility to ensure that you have adequate protection in the form of firewalls, antivirus software, and anti-spyware software and keep such software up to date.

Keep electrical appliances away from your device. These include electric fans, radios, high-powered speakers, air-conditioners, and microwave ovens. The strong magnetic fields generated by electrical appliances can damage the screen and the data on the device.

Be aware of heat generated by your device

When your device is turned on or the battery is charging, some parts might become hot. The temperature that they reach depends on the amount of system activity and the battery charge level. Extended contact with your body, even through clothing, could cause discomfort or even a skin burn. Avoid keeping your hands, your lap, or any other part of your body in contact with a hot section of the device for any extended time.

Electronic emission notices

FCC Compliance Statement

This equipment has been tested and found to comply with the limits for a Class B digital device, pursuant to Part 15 of the FCC Rules. These limits are designed to provide reasonable protection against harmful interference in a residential installation. This equipment generates, uses, and can radiate radio frequency energy and, if not installed and used in accordance with the instructions, may cause harmful interference to radio communications. However, there is no guarantee that interference will not occur in a particular installation. If this equipment does cause harmful interference to radio or television reception, which can be determined by turning the equipment off and on, the user is encouraged to try to correct the interference by one or more of the following measures:

- Reorient or relocate the receiving antenna.
- Increase the separation between the equipment and receiver.
- Connect the equipment to an outlet on a circuit different from that to which the receiver is connected.
- Consult an authorized dealer or service representative for help.

Lenovo is not responsible for any radio or television interference caused by unauthorized changes or modifications to this equipment. Unauthorized changes or modifications could void the user's authority to operate the equipment.

This device complies with Part 15 of the FCC Rules. Operation is subject to the following two conditions: (1) this device may not cause harmful interference, and (2) this device must accept any interference received, including interference that may cause undesired operation.

Responsible Party:

Lenovo (United States) Incorporated

1009 Think Place - Building One

Morrisville, NC 27560

Telephone: 1-919-294-5900

ISED Caution

This device complies with Innovation, Science and Economic Development Canada license-exempt RSS standard(s). Operation is subject to the following two conditions:

(1) This device may not cause interference, and (2) this device must accept any interference, including interference that may cause undesired operation of the device.

Le présent appareil est conforme aux CNR d'Industrie Canada applicables aux appareils radio exempts de licence. L'exploitation est autorisée aux deux conditions suivantes:

(1) l'appareil ne doit pas produire de brouillage, et

(2) l'utilisateur de l'appareil doit accepter tout brouillage radioélectrique subi, même si le brouillage est susceptible d'en compromettre le fonctionnement.

Japanese VCCI Class B statement

この装置は、クラス B 情報技術装置です。この装置は、家庭環境で使用することを目的としていますが、この装置がラジオやテレビジョン受信機に近接して使用されると、受信障害を引き起こすことがあります。取扱説明書に従って正しい取り扱いをして下さい。VCCI-B

Japan compliance statement for products that connect to power mains rated at less than or equal to 20A per phase

日本の定格電流が 20A/ 相以下の機器に対する高調波電流規制

高調波電流規格 JIS C 61000-3-2 適合品

Environmental, recycling, and disposal information

General recycling statement

Lenovo encourages owners of information technology (IT) equipment to responsibly recycle their equipment when it is no longer needed. Lenovo offers a variety of programs and services to assist equipment owners in recycling their IT products. For information on recycling Lenovo products, go to <http://www.lenovo.com/recycling>.

Important battery and WEEE information

Take back and recycling information for WEEE and batteries/accumulators in the European Union and the United Kingdom



The crossed-out wheeled bin marking applies only to countries with WEEE and batteries waste regulations within the European Union (EU), and United Kingdom (UK).

Appliances and batteries/accumulators are labeled in accordance with local regulations concerning waste electrical and electronic equipment (WEEE) and waste batteries and waste accumulators. These regulations determine the framework for the return and recycling of used appliances and used batteries/accumulators as applicable within each geography. This label is applied to various products to indicate that the product is not to be thrown away, but rather put in the established collection systems for reclaiming these end of life products.

The label on the battery may also include a chemical symbol for the metal concerned in the battery (Pb for lead, Hg for mercury, and Cd for cadmium).

Users of electrical and electronic equipment (EEE) and users of batteries/accumulators with the crossed-out wheeled bin marking must not dispose of end of life products as unsorted municipal waste, but use the collection framework available to them for the return, recycle, and recovery of WEEE and waste batteries/accumulators and to minimize any potential effects of EEE and batteries on the environment and human health due to the presence of hazardous substances.

Lenovo electrical and electronic equipment (EEE) may contain parts and components, which at end-of-life might qualify as hazardous waste.

EEE and waste electrical and electronic equipment (WEEE) can be delivered free of charge to the place of sale or any distributor that sells electrical and electronic equipment of the same nature and function as the used EEE or WEEE.

Before placing electrical and electronic equipment (EEE) in the waste collection stream or in waste collection facilities, the end user of equipment containing batteries and/or accumulators must remove those batteries and accumulators for separate collection.

Dispose of lithium batteries and battery packs from Lenovo products:

A coin-cell type lithium battery might be installed inside your Lenovo product. You can find details about the battery in the product documentation. If the battery needs to be replaced, contact your place of purchase or contact Lenovo for service. If you need to dispose of a lithium battery, insulate it with vinyl tape, contact your place of purchase or a waste-disposal operator, and follow their instructions.

Your Lenovo device might contain a lithium-ion battery pack or a nickel metal hydride battery pack. You can find details on the battery pack in the product documentation. If you need to dispose of a battery pack, insulate it with vinyl tape, contact Lenovo sales, service, or your place of purchase, or a waste-disposal operator, and follow their instructions. You also can refer to the instructions provided in the *user guide* for your product.

For proper collection and treatment, go to: <https://www.lenovo.com/environment>.

For additional WEEE information, go to: <https://www.lenovo.com/recycling>.

Battery recycling information for Brazil

Declarações de Reciclagem no Brasil

Descarte de um Produto Lenovo Fora de Uso Equipamentos elétricos e eletrônicos não devem ser descartados em lixo comum, mas enviados à pontos de coleta, autorizados pelo fabricante do produto para que sejam encaminhados e processados por empresas especializadas no manuseio de resíduos industriais, devidamente certificadas pelos órgãos ambientais, de acordo com a legislação local. A Lenovo possui um canal específico

para auxiliá-lo no descarte desses produtos. Caso você possua um produto Lenovo em situação de descarte, ligue para o nosso SAC ou encaminhe um e-mail para: reciclar@lenovo.com, informando o modelo, número de série e cidade, a fim de enviarmos as instruções para o correto descarte do seu produto Lenovo.

Recycling information for Japan

Recycling and disposal information for Japan is available at

<http://www.lenovo.com/recycling/japan>.

Recycling information for India

Recycling and disposal information for India is available at

https://www.lenovo.com/in/en/social_responsibility/sustainability/ptb_india.html.

Battery recycling marks

- The battery recycling information of Taiwan



- Battery recycling information for the United States and Canada



U.S. & Canada Code

ENERGY STAR model information



ENERGY STAR® is a joint program of the U.S. Environmental Protection Agency and the U.S. Department of Energy aimed at saving money and protecting the environment through energy efficient products and practices.

Lenovo is proud to offer our customers products with the ENERGY STAR qualified designation. You might find an ENERGY STAR mark affixed on the computer or displayed on the power settings interface. Lenovo tablets of the following model name, if carry an ENERGY STAR mark, have been designed and tested to conform to the ENERGY STAR program requirements for tablets.

TB370FU

By using ENERGY STAR qualified products and taking advantage of the power-management features of the tablet, you can help reduce the consumption of electricity. Reduced electrical consumption can contribute to potential financial savings, a cleaner environment, and the reduction of greenhouse gas emissions.

For more information about ENERGY STAR, go to <http://www.energystar.gov>.

Lenovo encourages you to make efficient use of energy an integral part of your day-to-day operations. To help in this endeavor, Lenovo has preset the following power-management features to take effect when the computer has been inactive for a specified length of time:

Power plan: Default

Turn off the display: After 30 seconds.

Press the power button to turn on the display.

The Wake on LAN function: NA

Export classification notice

This product is subject to the United States Export Administration Regulations (EAR) and has an Export Classification Control Number (ECCN) of 5A992.c. It can be re-exported except to any of the embargoed countries in the EAR E1 country list.

Dolby certification

Dolby, Dolby Atmos, and the double-D symbol are registered trademarks of Dolby Laboratories Licensing Corporation. Manufactured under license from Dolby Laboratories. Confidential unpublished works. Copyright © 2012-2023 Dolby Laboratories. All rights reserved.

HEVC Standard

This product supports digital video coding under certain versions of HEVC standard and is covered by patents at patentlist.accessadvance.com.

