

User's Manual

Desktop Monitor

MultiSync EA242F

MultiSync EA272F

MODEL: EA242F, EA242F-BK, EA272F, EA272F-BK

The regulations for this monitor applied to one of model names listed above.

Please find your model name in the label on the rear side of the monitor.

Table of Contents

Registration Information	1	Important Information	3
TCO Certified	1		

Product Features

Chapter 1 Installation

Parts Name and Functions	12	Adjustable Stand with Pivot Capability	19
Control Panel	12	Flexible Arm Installation	20
Terminal Panel	13	Remove the Monitor Stand for Mounting	20
Connections	14	Mount the Flexible Arm	20
Connecting Video	14	ControlSync	21
Setup	16	Multiple monitors connection using DisplayPort	23

Chapter 2 Basic Operation

Using the OSD (On-Screen Display) Controls	26	Power management function LED indicator patterns	27
Changing the Input	27		

Chapter 3 Troubleshooting

Screen Image and Video Signal Issues	29	Human Sensing function	33
Hardware Issues	30	Using the Auto Brightness function	34
Image Persistence	32		

Chapter 4 Specifications

EA242F	36	EA272F	37
--------------	----	--------------	----

Appendix A OSD Controls List

ECO TOOLS	39	MULTI DISPLAY	45
SCREEN	40	ECO INFORMATION	46
COLOR	42	INFORMATION	46
TOOLS	42	OSD Warning	46
MENU TOOLS	43		

Appendix B Manufacturer's Recycling and Energy Information

Disposing of your old NEC product	48	WEEE Mark (European Directive 2012/19/EU and amendments)	48
Energy Saving	48		

Registration Information

Cable Information

CAUTION: Use the provided specified cables with this product so as not to interfere with radio and television reception.
For DisplayPort, HDMI, USB and USB-C®, please use a shielded signal cable.
For mini D-Sub 15-pin, please use a shielded signal cable with ferrite core.
Use of other cables and adapters may cause interference with radio and television reception.

FCC Information

WARNING: The Federal Communications Commission does not allow any modifications or changes to the unit EXCEPT those specified by NEC Display Solutions of America, Inc. in this manual. Failure to comply with this government regulation could void your right to operate this equipment.

1. The power supply cord you use must have been approved by and comply with the safety standards of U.S.A., and meet the following condition.

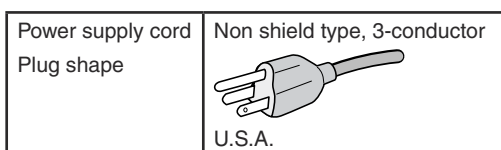

2. This equipment has been tested and found to comply with the limits for a Class B digital device, pursuant to part 15 of the FCC Rules. These limits are designed to provide reasonable protection against harmful interference in a residential installation. This equipment generates, uses and can radiate radio frequency energy, and, if not installed and used in accordance with the instructions, may cause harmful interference to radio communications. However, there is no guarantee that interference will not occur in a particular installation. If this equipment does cause harmful interference to radio or television reception, which can be determined by turning the equipment off and on, the user is encouraged to try to correct the interference by one or more of the following measures:
 - Reorient or relocate the receiving antenna.
 - Increase the separation between the equipment and receiver.
 - Connect the equipment into an outlet on a circuit different from that to which the receiver is connected.
 - Consult the dealer or an experienced radio/TV technician for help.

If necessary, the user should contact the dealer or an experienced radio/television technician for additional suggestions. The user may find the following booklet, prepared by the Federal Communications Commission, helpful: "How to Identify and Resolve Radio-TV Interference Problems." This booklet is available from the U.S. Government Printing Office, Washington, D.C., 20402, Stock No. 004-000-00345-4.

SUPPLIER'S DECLARATION OF CONFORMITY

This device complies with Part 15 of FCC Rules. Operation is subject to the following two conditions. (1) This device may not cause harmful interference, and (2) this device must accept any interference received, including interference that may cause undesired operation.

FC	U.S. Responsible Party:	NEC Display Solutions of America, Inc.
	Address:	3250 Lacey Rd, Ste 500 Downers Grove, IL 60515 (630) 467-3000
	Tel. No.:	
	Type of Product:	Display Monitor
	Equipment Classification:	Class B Peripheral
	Model:	MultiSync EA242F (EA242F, EA242F-BK) MultiSync EA272F (EA272F, EA272F-BK)



TCO Certified

TCO Certified — a third-party sustainability certification for IT products

TCO Certified is a global sustainability certification for IT products, available for computers, mobile devices, display products and data center products. Criteria cover both social and environmental sustainability and enable circular solutions. Compliance with criteria is independently verified. TCO Certified is a third-party certification in accordance with ISO 14024.

To see a list of our TCO certified monitors and their TCO Certification (in English only), visit our website at:

https://www.nec-display.com/global/about/legal_regulation/TCO_mn/index.html

⚠ CAUTION: Please refer to "CAUTION 2".

- The intended primary use of this product is as an Information Technical Equipment in an office or domestic environment.
- The product is intended to be connected to a computer and is not intended for the display of television broadcast signals.

Trademarks Information

Microsoft® and Windows® are either registered trademarks or trademarks of Microsoft Corporation in the United States and/or other countries.

NEC is a registered trademark of NEC Corporation.

DisplayPort™ and the DisplayPort™ logo are trademarks owned by the Video Electronics Standards Association (VESA®) in the United States and other countries.

MultiSync is a trademark or registered trademark of NEC Display Solutions, Ltd. in Japan and other countries.

ErgoDesign is a registered trademark of NEC Display Solutions, Ltd. in Austria, Benelux, Denmark, France, Germany, Italy, Norway, Spain, Sweden, U.K.

The terms HDMI and HDMI High-Definition Multimedia Interface, and the HDMI Logo are trademarks or registered trademarks of HDMI Licensing Administrator, Inc. in the United States and other countries.

Adobe and the Adobe logo are either registered trademarks or trademarks of Adobe Systems Incorporated in the United States and/or other countries.

USB Type-C® and USB-C® are registered trademarks of USB Implementers Forum.

NaViSet is a trademark or registered trademark of NEC Display Solutions, Ltd. in Japan, in the United States and other countries.

All other brands and product names are trademarks or registered trademarks of their respective owners.



- NOTE:**
- (1) The contents of this user's manual may not be reprinted in part or whole without permission.
 - (2) The contents of this user's manual are subject to change without notice.
 - (3) Great care has been taken in the preparation of this user's manual; however, should you notice any questionable points, errors or omissions, please contact us.
 - (4) The image shown in this user's manual is indicative only. If there is inconsistency between the image and the actual product, the actual product shall govern.
 - (5) Notwithstanding articles (3) and (4), NEC will not be responsible for any claims on loss of profit or other matters deemed to result from using this device.
 - (6) This manual is commonly provided to all regions so they may contain descriptions that are pertinent for other countries.



Important Information

Safety Precautions and Maintenance







FOR OPTIMUM PERFORMANCE, PLEASE NOTE
THE FOLLOWING WHEN SETTING UP AND
USING THE LCD COLOR MONITOR:







About the Symbols

To ensure safe and proper use of the product, this manual uses a number of symbols to prevent injury to you and others as well as damage to property. The symbols and their meanings are described below. Be sure to understand them thoroughly before reading this manual.





 WARNING	Failing to heed this symbol and handling the product incorrectly could result in accidents leading to major injury or death.
 CAUTION	Failing to heed this symbol and handling the product incorrectly could result in personal injury or damage to surrounding property.

Examples of symbols





	<p> Indicates a warning or caution. This symbol indicates you should be careful of electric shocks.</p>
	<p> Indicates a prohibited action. This symbol indicates something that must be prohibited.</p>
	<p> Indicates a mandatory action. This symbol indicates that the power cord should be unplugged from the power outlet.</p>

 WARNING	
1	<div style="display: flex; align-items: center;">  <div> <p>UNPLUG THE POWER CORD</p> </div> </div> <p>Unplug the power cord if the product malfunctions.</p> <p>Should the product emit smoke or strange odors or sounds, or if the product has been dropped or the cabinet broken, turn off the product's power, then unplug the power cord from the power outlet. Failure to do so could not only lead to fire or electric shock, it could also result in vision impairment. Contact your dealer for repairs.</p> <p>Never try to repair the product on your own. Doing so is dangerous.</p>
2	<div style="display: flex; align-items: center;">    </div> <p>Do not open or remove the product's cabinet.</p> <p>Do not disassemble the product.</p> <p>There are high voltage areas in the product. Opening or removing product covers and modifying the product may expose you to electric shock, fire, or other risks.</p> <p>Refer all servicing to qualified service personnel.</p>
3	<div style="display: flex; align-items: center;">  </div> <p>Do not use the product if it has structural damage or if its stand has cracked or peeled.</p> <p>If you notice any structural damage such as cracks or unnatural wobbling, please refer servicing to qualified service personnel. If the product is used in this condition, the product may fall or cause personal injury.</p>











 **WARNING**



4		<p>Handle the power cord with care. Damaging the cord could lead to fire or electric shock.</p> <ul style="list-style-type: none">• Do not place heavy objects on the cord.• Do not place the cord under the product.• Do not cover the cord with a rug, etc.• Do not scratch or modify the cord.• Do not bend, twist or pull the cord with excessive force.• Do not apply heat to the cord. <p>Should the cord be damaged (exposed core wires, broken wires, etc.), ask your dealer to replace it.</p>
5		<p>Do not touch the power plug if you hear thunder. Doing so could result in electric shock.</p>
6		<p>Please use the power cord provided with this product in accordance with the power cord table.</p> <p>If a power cord is not supplied with this product, please contact NEC. For all other cases, please use the power cord with the plug style that matches the power socket where the product is located. The compatible power cord corresponds to the AC voltage of the power outlet and has been approved by, and complies with, the safety standards in the country of purchase.</p>
7	 	<p>Please install the product in accordance with the following information.</p> <p>When transporting, moving, or installing the product, please use as many people as necessary to be able to lift the product without causing personal injury or damage to the product.</p> <p>Please refer to the instructions included with the optional mounting equipment for detailed information about attaching or removing.</p> <p>Do not cover the vent on the product. Improper installation of the product may result in damage to the product, an electric shock or fire.</p> <p>Do not install the product in the locations below:</p> <ul style="list-style-type: none">• Poorly ventilated spaces.• Near a radiator, other heat sources, or in direct sunshine.• Continual vibration areas.• Humid, dusty, steamy, or oily areas.• Outdoors.• High-temperature, environment where humidity changes rapidly and condensation is likely to occur.• Do not mount the product in any configuration or position not described in the user's manual.

 **WARNING**

8		<p>Prevent tipping and falling for earthquakes or other shocks.</p> <p>To prevent personal injury or damage to the product caused by tipping over due to earthquakes or other shocks, make sure to install the product in a stable location and take measures to prevent falling.</p> <ul style="list-style-type: none"> • The product must be mounted to an approved flexible arm (e.g. TUEV GS mark) or stand that supports the weight of the product to prevent damage and personal injury that could result from the product tipping over or falling. • Only use the screws that were removed from the product's stand or the specified screws to avoid damage to the product or the stand. • Please tighten all screws (Recommended Fasten Force: 98 - 137 N•cm) when installing the product to a flexible arm or stand. A loose screw may cause the product to fall, causing damage to the product or personal injury. • Attaching the flexible arm should be performed by two or more people if the product cannot be placed face-down on a flat surface for installation. <p>Stability Hazard.</p> <p>The product may fall, causing serious personal injury or death. To prevent injury, this product must be securely attached to the floor/wall in accordance with the installation instructions. Many injuries, particularly to children, can be avoided by taking simple precautions such as:</p> <ul style="list-style-type: none"> • ALWAYS use stands or installation methods recommended by the manufacturer of the product set. • ALWAYS use furniture that can safely support the product. • ALWAYS ensure the product is not overhanging the edge of the supporting furniture. • ALWAYS educate children about the dangers of climbing on furniture to reach the product or its controls. • ALWAYS route cords and cables connected to your product so they cannot be tripped over, pulled or grabbed. • NEVER place a product in an unstable location. • NEVER place the product on tall furniture (for example, cupboards or bookcases) without anchoring both the furniture and the product to a suitable support. • NEVER place the product on cloth or other materials that may be located between the product and supporting furniture. • NEVER place items that might tempt children to climb, such as toys and remote controls, on the top of the product or furniture on which the product is placed. <p>If the existing product is going to be retained and relocated, the same considerations as above should be applied.</p>
9		<p>Do not place this product on a sloping or unstable cart, stand or table. Doing so could lead to falling or tipping and cause personal injury.</p>
10		<p>Do not insert objects of any kind into the cabinet slots. It may cause electric shock, fire, or product failure. Keep objects away from children and babies.</p>
11		<p>Do not spill any liquids into the cabinet or use your product near water.</p> <p>Immediately turn off the power and unplug your product from the wall outlet, then refer servicing to qualified service personnel. It may cause an electric shock or start a fire.</p>
12		<p>Do not use flammable gas sprays to remove dust when cleaning the product. Doing so could lead to a fire.</p>

 **CAUTION**

1	  	<p>Handling the power cord.</p> <p>Handle the power cord with care. Damaging the cord could lead to fire or electric shock.</p> <ul style="list-style-type: none"> • When connecting the power cord to the product's AC IN terminal, make sure the connector is fully and firmly inserted. • Make sure the power cord cannot be easily disconnected. • Do not connect or disconnect the power cord with wet hands. • When connecting or disconnecting the power cord, pull the power cord out by holding onto its plug. • When cleaning the product, for safety purposes, unplug the power cord from the power outlet beforehand. Regularly dust off the power cord by using a soft dry cloth. • Before moving the product, make sure the product power is off, then unplug the power cord from the power outlet and check that all cables connecting the product to other devices are disconnected. • When you are not planning to use the product for an extended period of time, always unplug the power cord from the power outlet. • This equipment is designed to be used in the condition of the power cord connected to the earth. If the power cord is not connected to the earth, it may cause electric shock. Please make sure the power cord is earthed properly.
2		<p>Please confirm the distribution system in building installation shall provide the circuit breaker rated 120/240 V, 20 A (maximum).</p>
3		<p>Do not bind the power cord and the USB cable. It may trap heat and cause a fire.</p>
4		<p>Do not climb on the table where the product is installed. Do not install the product on a wheeled table if the wheels on the table have not been properly locked. The product may fall, causing damage to the product or personal injury.</p>
5		<p>Installation, removal, and adjustment of the stand.</p> <ul style="list-style-type: none"> • Handle with care when pulling the stand as it might pinch your fingers. • Before rotating the screen, disconnect the power cord and all cables from the product. Otherwise, the power cord or cables might pull with excessive force and cause personal injury or damage to the product. • When rotating the screen, slide it to the highest level and set it to the maximum tilt. Otherwise, it could cause personal injury or knock the screen on the desk.
6		<p>Do not push the product.</p> <p>The product may fall, causing damage to the product or personal injury.</p>
7		<p>Do not impact the LCD panel surface, it can cause serious damage to the product or personal injury.</p>
8		<p>Suitable for entertainment purposes at controlled luminous environments, to avoid disturbing reflections from the screen.</p>
9		<p>Do not connect headphones to the product while you are wearing them. Depending on the volume level, it may damage your ears and cause loss of hearing.</p>

 CAUTION	
10	 <p>Do not play with the plastic bag which covers the product.</p> <p>Do not use this bag for any other purpose. To avoid the danger of suffocation, do not place this bag over your head, nose or mouth. Do not place this bag over another person's head, nose or mouth.</p> <p>Keep this bag away from children and babies.</p>
11	 <p>To ensure the product's reliability, please clean the ventilation holes at the rear side of the cabinet at least once a year to remove dirt and dust. Failure to do so could lead to fire or electric shock or damage to the product.</p>

Power Cord Table

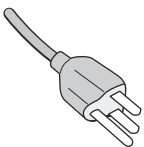
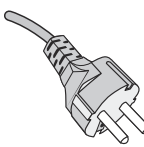
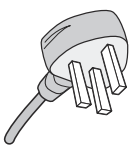
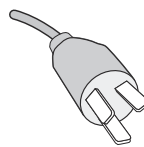
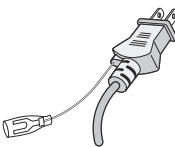
Plug Type	North America	European Continental	U.K.	Chinese	Japanese
Plug Shape					
Region	U.S.A./Canada	EU	U.K.	China	Japan
Voltage	120*	230	230	220	100

* Please use this power cord under 125 V power supply.

NOTE: This product can only be serviced in the country where it was purchased.

Image Persistence

Image persistence occurs when a residual or "ghost" image of a previous image remains visible on the screen. Unlike CRT monitors, LCD monitors' image persistence is not permanent, but a still image being displayed for a long period of time should be avoided.

To alleviate image persistence, turn off the monitor for as long as the previous image was displayed. For example, if an image was on the monitor for one hour and a residual image remains, the monitor should be turned off for one hour to erase the image.

NOTE: As with all personal display devices, NEC DISPLAY SOLUTIONS recommends using a moving screen saver at regular intervals whenever the screen is idle, or turn off the monitor when not in use.

Ergonomics

CORRECT PLACEMENT AND ADJUSTMENT OF THE MONITOR CAN REDUCE EYE, SHOULDER, AND NECK FATIGUE. CHECK THE FOLLOWING WHEN YOU POSITION THE MONITOR:

To realize the maximum ergonomics benefits, we recommend the following:

- For optimum performance of the monitor, allow 20 minutes for warming up. Avoid reproduction of still patterns on the monitor for long periods of time to avoid image persistence (after image effects).
- Adjust the monitor height so that the top of the screen is at or slightly below eye level. Your eyes should look slightly downward when viewing the middle of the screen.
- Position your monitor no closer than 40 cm (15.75 inches) and no further away than 70 cm (27.56 inches) from your eyes. The optimal distance is 50 cm (19.69 inches).
- Rest your eyes periodically for 5 to 10 minutes for every 1 hour by focusing on an object at least 20 feet away.
- Position the monitor at a 90° angle to windows and other light sources to minimize glare and reflections. Adjust the monitor tilt so that ceiling lights do not reflect on your screen.
- If reflected light makes it hard for you to see your screen, use an anti-glare filter.
- Adjust the monitor's brightness and contrast controls to enhance readability.
- Use a document holder placed close to the screen.
- Position whatever you are looking at most of the time (the screen or reference material) directly in front of you to minimize turning your head while you are typing.
- Blink often. Eye exercise helps to reduce eye strain. Please contact your ophthalmologist. Get regular eye checkups.
- To avoid eye fatigue, adjust the brightness to a moderate setting. Place a sheet of white paper next to the LCD screen for luminance reference.
- Do not position the Contrast control to its maximum setting.
- Use the preset Size and Position controls with standard signals.
- Use the preset Color Setting.
- Use non-interlaced signals.
- Do not use primary color blue on a dark background, as it is difficult to see and may produce eye fatigue due to insufficient contrast.

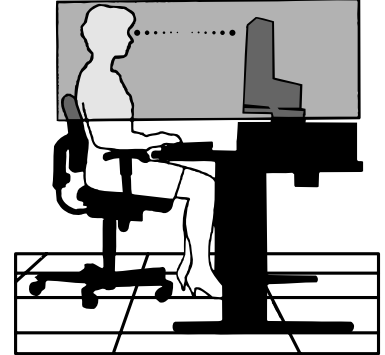

For more detailed information on setting up a healthy work environment, write to the American National Standard for Human Factors Engineering of Computer Workstations - ANSI/HFES 100-2007 - The Human Factors Society, Inc. P.O. Box 1369, Santa Monica, California 90406.

Cleaning the LCD Screen

- When the LCD Screen is dusty, please gently wipe with a soft cloth.
- Clean the LCD screen surface with a lint-free, non-abrasive cloth. Avoid using any cleaning solution or glass cleaner!
- Please do not rub the LCD Screen with hard or coarse material.
- Please do not apply pressure to the LCD Screen surface.
- Please do not use OA cleaner as it will cause deterioration or discoloration on the LCD Screen surface.

Cleaning the Cabinet

- Unplug the power supply.
- Gently wipe the cabinet with a soft cloth.
- To clean the cabinet, dampen the cloth with a neutral detergent and water, wipe the cabinet and follow with a dry cloth.

NOTE: DO NOT clean with benzene thinner, alkaline detergent, alcoholic system detergent, glass cleaner, wax, polish cleaner, soap powder, or insecticide. Rubber or vinyl should not be in contact with the cabinet for an extended period of time. These types of fluids and materials can cause the paint to deteriorate, crack or peel.

Product Features

- **3-side Narrow Bezel**

Stylish appearance with less distance between adjacent screens in a multi-monitor setup.

- **USB Type-C With Power Delivery**

Supports video and audio input, USB hub function, and supplies power to connected devices by a single cable, providing flexible connectivity in a tidy work environment.

- **DisplayPort Out**

DisplayPort out connection for daisy chain setup with multiple monitors for easy cable management.

- **Fully Ergonomic Stand**

Provides viewing flexibility with 150 mm height adjustment, -5 ~ 35-degree tilt and 340-degree swivel, with cable management and a small footprint. Pivoting helps to minimize space between adjacent bezels in multi-monitor installations; adjustable height allows the bottom of the cabinet to touch the stand base for lower positioning requirements.

- **ErgoDesign Features**

Enhanced human ergonomics to improve the working environment, help protect the user's health, and save money. The ergonomic features include a fully articulating stand, OSD controls that can rotate 90/180/270 degrees for quick and easy image adjustment, and lower emissions.

- **VESA Standard Mounting Interface**

Connects the monitor to any VESA standard third party mounting arm or bracket.

- **Various Signal Interfaces**

Supports a variety of video signal interfaces. See [page 13](#).

- **Plug and Play**

The Microsoft® solution with the Windows® operating system facilitates setup and installation by allowing the monitor to send its capabilities (such as screen size and resolutions supported) directly to the computer, automatically optimizing display performance.

- **USB Hub 3.1 Gen.1**

The USB hub adds flexibility to your computing by providing easy access to USB SuperSpeed data transfer and charging via USB. See [page 13](#).

- **Hardware Calibration**

Adjusts brightness, colors, and gamma curve to user preference using software and a color sensor.

- **USB Monitor Control**

Allows user adjustment of monitor settings through application software by connecting a USB cable.

- **Color Control Systems**

Adjusts the screen colors and allows customization of the color accuracy of the monitor to a variety of standards.

- **Human/Ambient Sensors**

Controls screen brightness according to user presence and ambient light status for less power consumption.

- **Response Improve**

Improves gray-to-gray response (see [page 41](#)).

- **Intelligent Power Manager System**

Provides innovative power-saving methods that allow the monitor to shift to a lower-power mode when on but not in use, reducing emissions and lowering the cost of operating the monitor by reducing its power consumption.

- **ControlSync**

Provides control and settings synchronization for up to five MultiSync EA series displays, as well as individual control of any single monitor in the ControlSync chain, from a single master monitor (see [page 21](#)).

- **Individual Adjust**

A designated master monitor can adjust individual sub-monitor(s) via the OSD. It is useful for multi-monitor setups which are positioned far from the user (see [page 45](#)).

- **Customize Setting**

Stores the current settings and recovers stored settings (see [page 45](#)).

- **Low Blue Light**

Low Blue Light function substantially reduces blue light and helps to alleviate eye-strain (see [page 42](#)).

- **Flicker Free**

Special backlight system reduces flicker for less eyestrain.

- **NaViSet Administrator 2 Software**

Offers an expanded and intuitive graphical interface, allowing adjustments of the OSD display settings from a network PC.

This Chapter Includes:

- ⇒ “Parts Name and Functions” on page 12
- ⇒ “Connections” on page 14
- ⇒ “Setup” on page 16
- ⇒ “Flexible Arm Installation” on page 20
- ⇒ “ControlSync” on page 21
- ⇒ “Multiple monitors connection using DisplayPort” on page 23

Parts Name and Functions

Control Panel

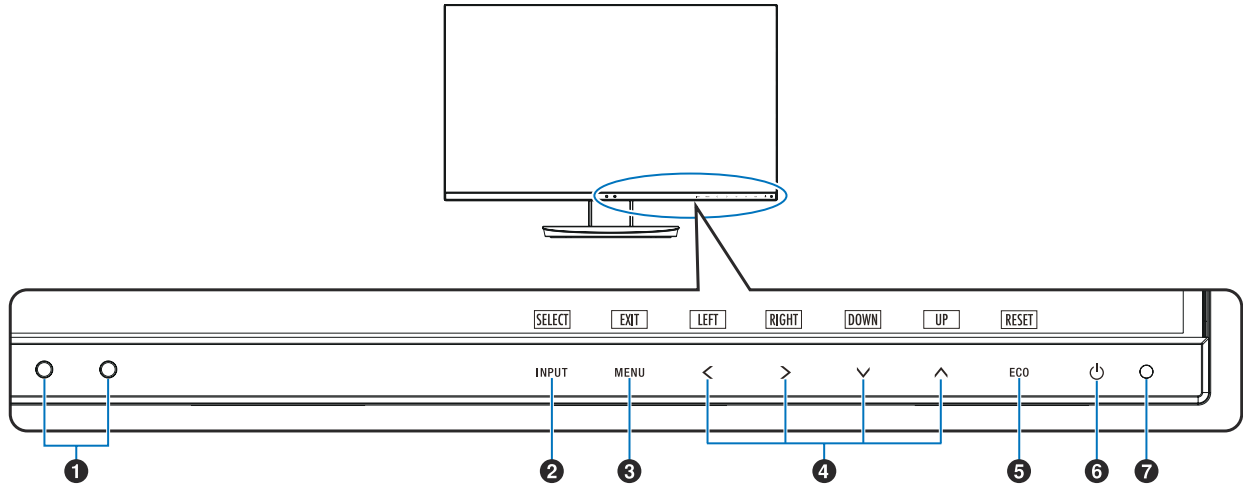

Item	Function
① Ambient Light Sensor Human Sensor	Detects the level of ambient lighting and the presence of a user, allowing the monitor to make adjustments to various settings resulting in a more comfortable viewing experience. Do not cover this sensor.
② INPUT/SELECT	Enters sub-menus in the OSD menu when the OSD menu is open. Shows a switching menu for the input source when the OSD menu is closed. You can directly change to the [L/B] (LOW BLUE LIGHT) mode by touching this key for 3 seconds or more when the OSD menu is closed.*1
③ MENU/EXIT	Opens the OSD menu. Closes the OSD sub-menus and main menu. You can restore the saved settings in the [CUSTOMIZE SETTING] by touching this key for 3 seconds or more when the OSD menu is closed.
④ LEFT/RIGHT/ UP/DOWN*2	When the OSD menu is open, navigates through the OSD menu. When the OSD menu is closed, touch one of the following keys to open the menu for the function indicated.*1 ^ key: [BRIGHTNESS] v key: [VOLUME]
⑤ ECO/RESET	When the OSD menu is open, this key sends a reset command for the OSD settings. When the OSD menu is closed, this key switches the [ECO MODE] status. You can set a mode from [OFF], [1] and [2].*1 Activates the [AUTO ADJUST] function by touching this key for 3 seconds or more when the OSD menu is closed (analog input only)*1.
⑥ Power	Turns the monitor on and off.
⑦ Power LED	Indicates that the power is on or off.

*1: When the [HOT KEY] function is [OFF], this function is disabled.

*2: Depending on the [OSD ROTATION] setting, [LEFT], [RIGHT], [UP] and [DOWN] key guides are displayed at the <, >, v, ^ keys differently (see page 44).

Terminal Panel

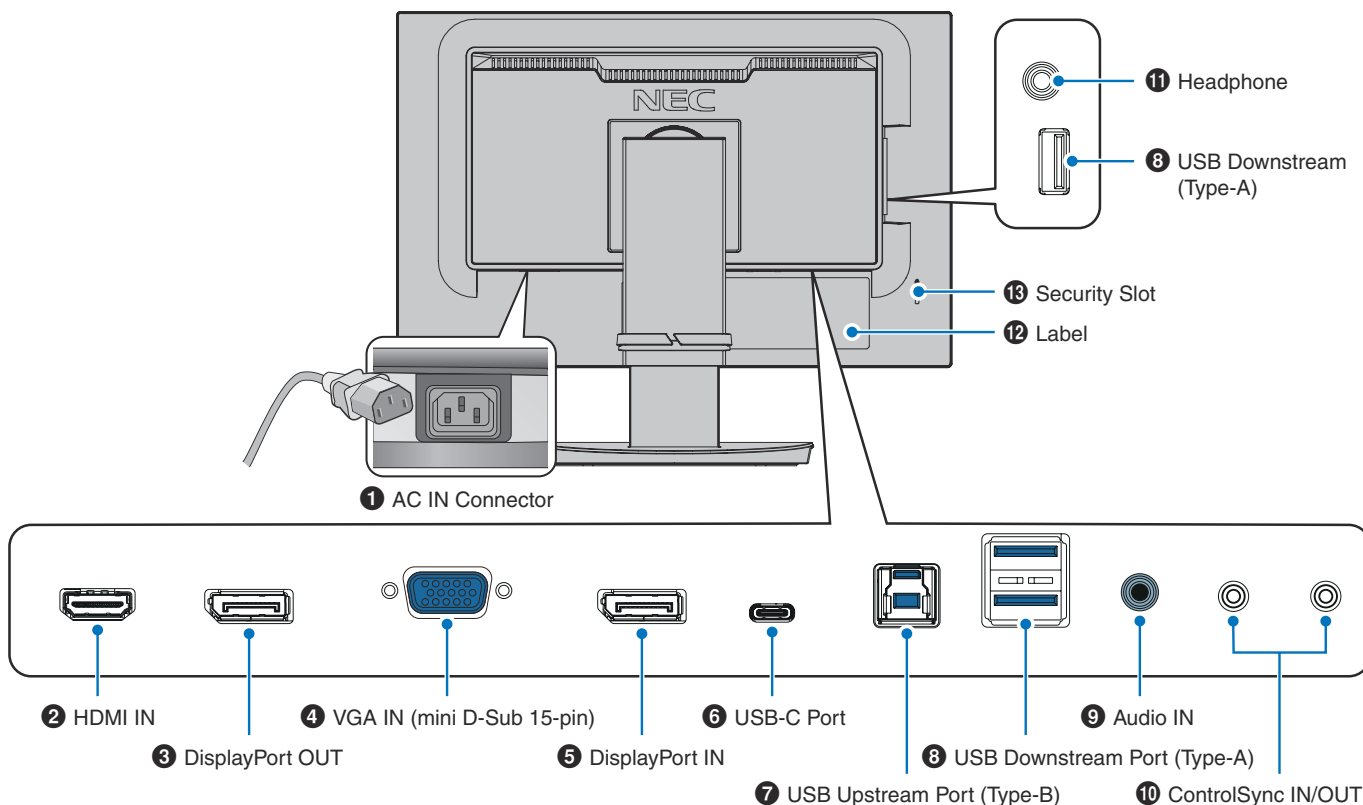

1 AC IN Connector

Connects with the supplied power cord.

2 HDMI IN

HDMI signals input.

3 DisplayPort OUT

DisplayPort signals output.
Connects with DisplayPort input of another monitor.

4 VGA IN (mini D-Sub 15-pin)

Analog RGB signals input.

5 DisplayPort IN

DisplayPort signals input.

6 USB-C Port

Connects with USB Type-C® compliant external equipment such as a computer. Charges a connected USB device (USB Power Delivery). See “Specifications” page.

- NOTE:**
- Supports DisplayPort signals input when a connected USB-C device complies with USB Power Delivery.
 - Functions as a USB hub.
 - Provides power delivery to a connected device when the function is enabled in the OSD ([USB FUNCTIONALITY] must be set to [AUTO] or [ON]).

7 USB Upstream Port (Type-B)

Connects with external equipment such as a computer. Please use this port to control the monitor from connected external equipment.

8 USB Downstream Port (Type-A)

Connects with USB devices.
Connects with external equipment such as a computer compliant with USB.

9 Audio IN

Audio signal input from external equipment such as a computer or player.

10 ControlSync IN/OUT

Connects with the supplied ControlSync cable. See [page 21](#).

11 Headphone Jack

Connects with headphones.

12 Label

13 Security Slot

Security and theft protection lock slot compatible with Kensington cables/equipment.
For products visit Kensington’s website.

Connections

Video Input Connections

- HDMI – High definition digital video and audio signal connection to a computer, streaming media player, Blu-ray player, game console, etc.
- DisplayPort – High definition digital video and audio signal connection to a computer.
- USB-C – Supports DisplayPort input of high definition digital video and audio signal (DisplayPort Alt Mode on USB Type-C only) connection to a computer. This display does not support other USB Type-C Alt Modes such as MHL and HDMI. This port is not for use with USB devices such as mice, keyboards, or storage media.

Connecting Video

The type of video connections that can be used to connect to a computer depends on the computer's display adapter.

The following table shows the typical factory preset signal timing for each connection type. Some display cards may not be able to support the required resolution for proper image reproduction with the selected connection. The monitor will show the proper image by automatically adjusting the factory preset timing signal.

<Major supported timings>

Resolution		Vertical Frequency	Scan Type	Notes
H	V			
640	x 480	60/72/75 Hz	p	
720	x 400	70 Hz	p	
720	x 480	60 Hz	p	
720	x 576	50 Hz	p	
800	x 600	56/60/72/75 Hz	p	SVGA
1024	x 768	60/70/75 Hz	p	XGA
1280	x 720	50/60 Hz	p	720p
1280	x 960	60/75 Hz	p	
1280	x 1024	60/75 Hz	p	SXGA
1440	x 900	60 Hz	p	
1680	x 1050	60 Hz	p	
1920	x 1080	50/60 Hz	p	1080p, Recommended (60 Hz)

p: Progressive.

NOTE: When the selected monitor resolution is not a native panel resolution, the text contents appearance in the monitor screen is expanded in a horizontal or vertical direction to show the non-native resolution to full screen. This expansion is done by interpolated resolution technologies, which are normal and widely used in flat panel devices.

Connecting to a Computer with HDMI

- Please use an HDMI cable with the HDMI logo.
- It may take a moment for the signal to appear after turning on the computer.
- Some display cards or drivers may not display an image correctly.
- If the monitor's power is turned on after a connected computer is turned on, sometimes an image is not displayed. In this case, please turn off the computer then turn it on again.

Connecting to a Computer with DisplayPort

- Please use a DisplayPort cable with the DisplayPort compliance logo.
- It may take a moment for the signal to appear after turning on the computer.
- When connecting a DisplayPort cable to a component with a signal conversion adapter, an image may not appear.
- Some DisplayPort cables feature a locking function. When removing this cable, hold down the top button to release the lock.
- If the monitor's power is turned on after a connected computer is turned on, sometimes an image is not displayed. In this case, please turn off the computer then turn it on again.

Connecting to a Computer with USB Type-C

- When using USB-C port for video / audio, please use SuperSpeed USB 10Gbps (USB 3.1 Gen 2) cable with USB compliance logo.
- Hi-Speed USB (USB 2.0) cable or charging cable doesn't support video / audio transmission.
- When using USB-C port for video / audio, please use computer port with DP Alt Mode compliance logo.
- HDMI Alt Mode or MHL is not supported.
- When using computer battery charging (Power delivery), please use computer and cable with USB Power Delivery compliance logo.
- It may take a few seconds for the monitor to recognize the USB signal. Do not disconnect or reconnect the USB cable while the signal is being recognized.

Connecting USB Devices

- It may take a few seconds for the monitor to recognize the USB input. Do not disconnect the USB cable or disconnect and reconnect the USB cable before the monitor recognizes the input.
- Before turning off the power switch of the monitor or shutting down Windows®, please turn off the USB function and remove the USB device from the monitor. Data may be lost or corrupted if the USB device is not disconnected properly.

Setup

For box contents, please refer to the printed sheet provided in the box.

The accessories included depends on the location where the monitor was shipped.

To attach the base to the LCD monitor stand:

1. Place the monitor face down on a non-abrasive surface (**Figure 1**).
2. Please rotate the stand 90 degrees as shown in **Figure 1**.

CAUTION: Please refer to “CAUTION 5”.

3. Attach the base to the stand, then tighten the screw at the base's bottom (**Figure 2**).

NOTE: Reverse this procedure if you need to re-pack the monitor.

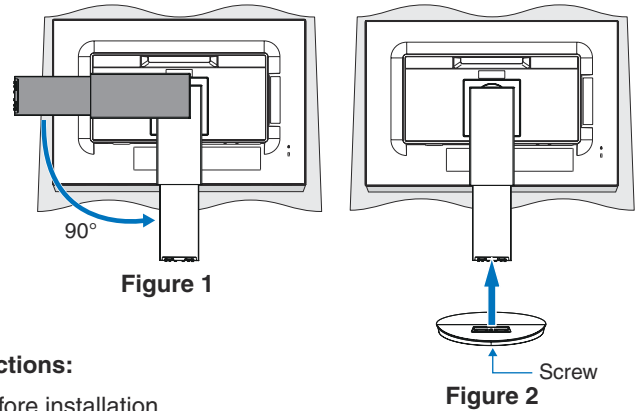

To connect the LCD monitor to your system, follow these instructions:

NOTE: Make sure to read “Important Information” on page 3 before installation.

1. Turn off the power to your computer.
2. Place your hands on each side of the monitor to tilt the panel to a maximum tilt angle and lift up to the highest position (**Figure 3**).

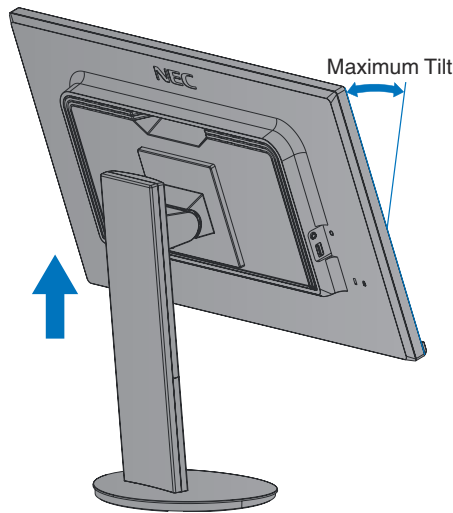
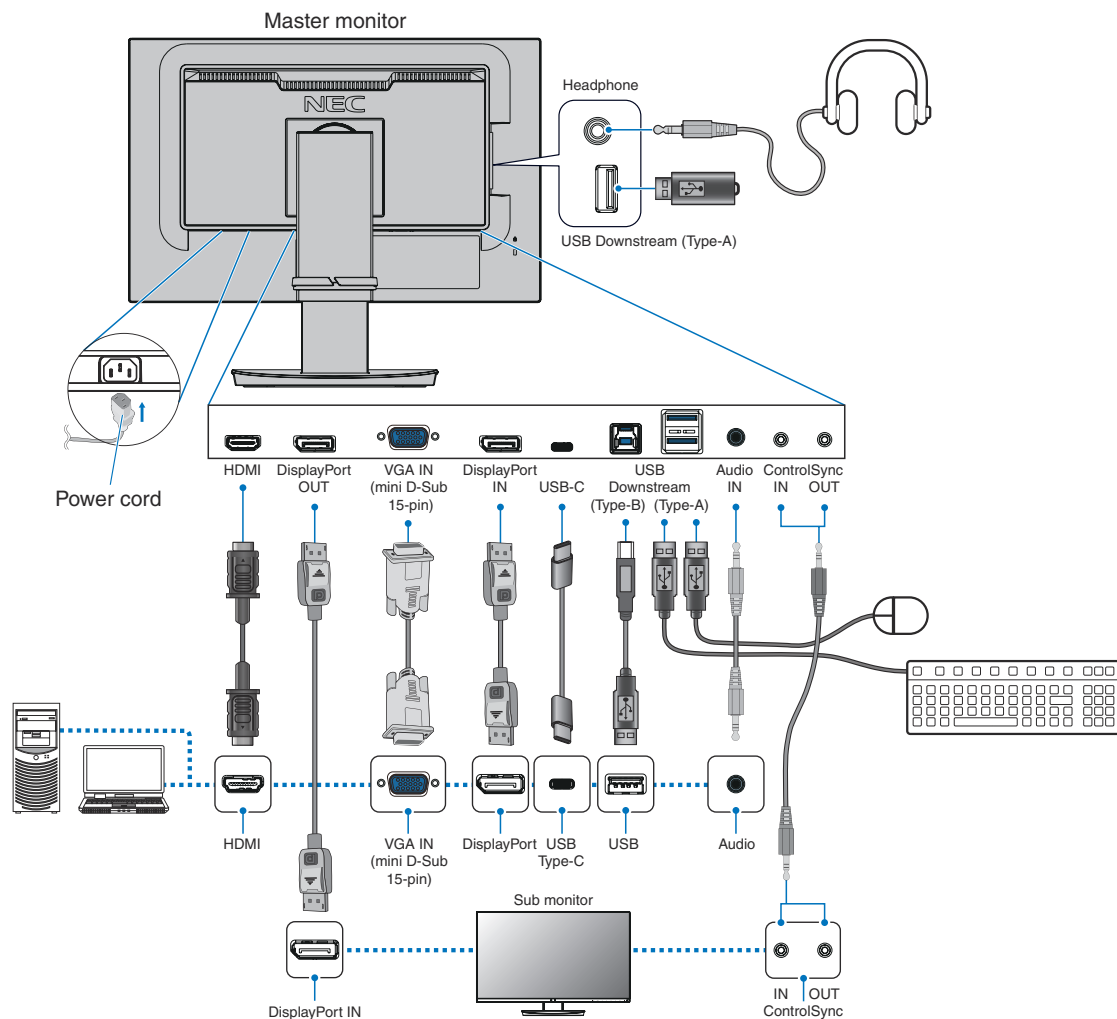

Figure 3

3. Connect devices to the monitor.

NOTE: Make sure the signal cable is fully connected to the monitor and the computer.



- NOTE:**
- When removing the DisplayPort cable, hold down the button to release the lock.
 - Please use a certified DisplayPort cable.
 - Please use a High Speed HDMI cable with the HDMI logo.

- CAUTION:**
- Use the provided specified cables with this product so as not to interfere with radio and television reception.
For DisplayPort, HDMI, USB and USB-C, please use a shielded signal cable.
For mini D-Sub 15-pin, please use a shielded signal cable with ferrite core.
Use of other cables and adapters may cause interference with radio and television reception.
 - Please refer to “CAUTION 3” and “CAUTION 9”.

- NOTE:**
- Adjustment of the volume control as well as the equalizer to other settings than the center position may increase the ear-/headphones output voltage and therefore the sound pressure level.
 - Incorrect cable connections may result in irregular operation, damage display quality/components of the LCD module and/or shorten the module’s life.
 - Do not use an attenuating (built-in resistor) audio cable. Using an audio cable with a built-in resistor will lower the sound level.

4. Place the cable holder onto the stand (**Figure 4**).
Place the cables in the cable holder firmly and evenly.

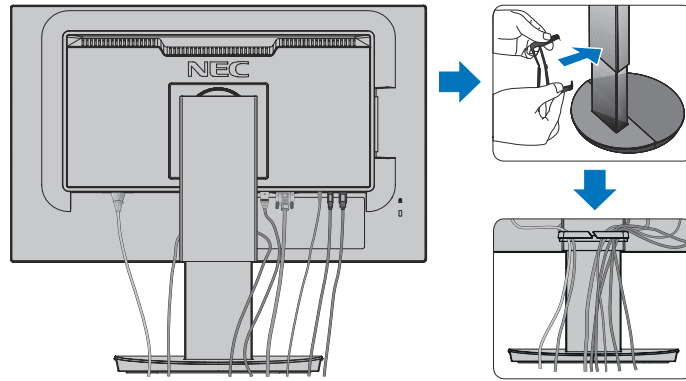

Figure 4

5. Please check that you can still rotate, raise and lower the monitor screen after you have installed the cables (**Figure 5** and **Figure 6**).

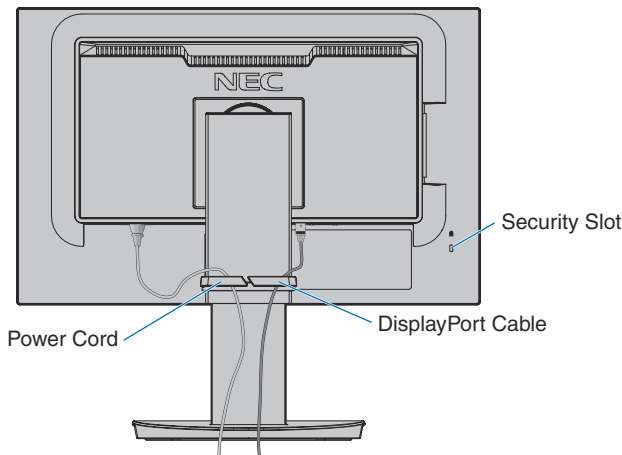

Figure 5

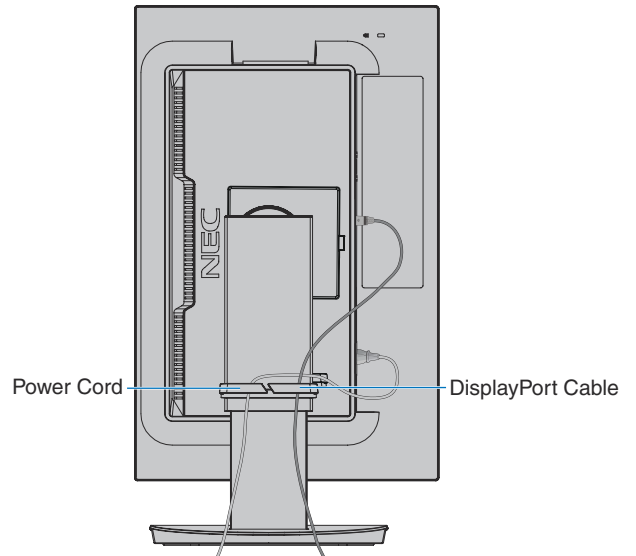



Figure 6

6. Connect the power cord to a power outlet.

NOTE:

- Please refer to the Caution section of this manual for proper selection of the AC power cord (see [page 7](#)).
- Please make sure that enough power is supplied to the monitor. Please refer to “[Power Supply](#)” in the “[Chapter 4 Specifications](#)” on [page 35](#).

7. Turn on the monitor by pressing the  key and then turn on the computer (**Figure 7**).
8. When using analog (VGA) input, No Touch Auto Adjust automatically adjusts the monitor to optimal settings upon initial setup. For further adjustments, use the following OSD controls:
 - [AUTO CONTRAST]
 - [AUTO ADJUST]

Refer to the “[OSD Controls List](#)” section of this User’s Manual for a full description of these OSD controls.

NOTE: If you have any problems please refer to the Troubleshooting section of this User’s Manual (see [page 28](#)).

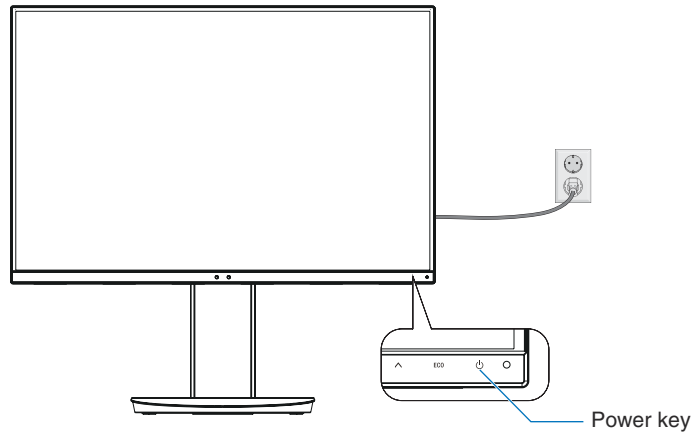
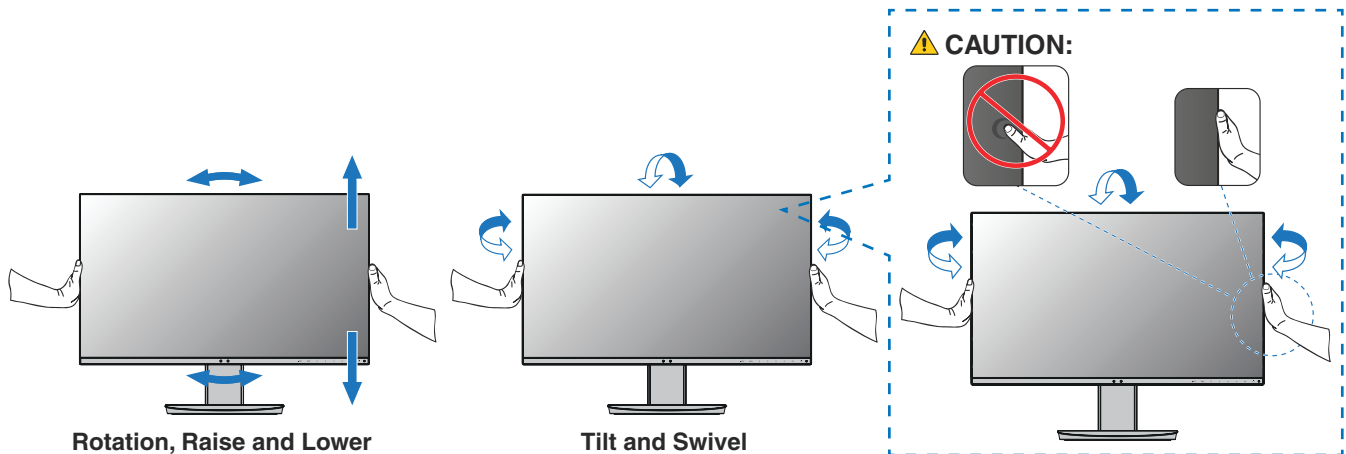

Figure 7

Adjustable Stand with Pivot Capability

Hold the monitor on each side and adjust the screen position as desired.

For screen rotation (pivot), hold the monitor on each side, lift to its maximum height and turn it from landscape to portrait.



CAUTION: Please refer to “[CAUTION 5](#)”.

Flexible Arm Installation

This monitor is designed for use with a flexible arm. Contact NEC for more information.

Follow the instructions provided by the manufacturer of the display mount. Remove the monitor stand before mounting.

⚠ WARNING: Please refer to "WARNING 8". See the Specifications on page 35 for details.

Remove the Monitor Stand for Mounting

NOTE: Handle with care when removing the monitor stand.

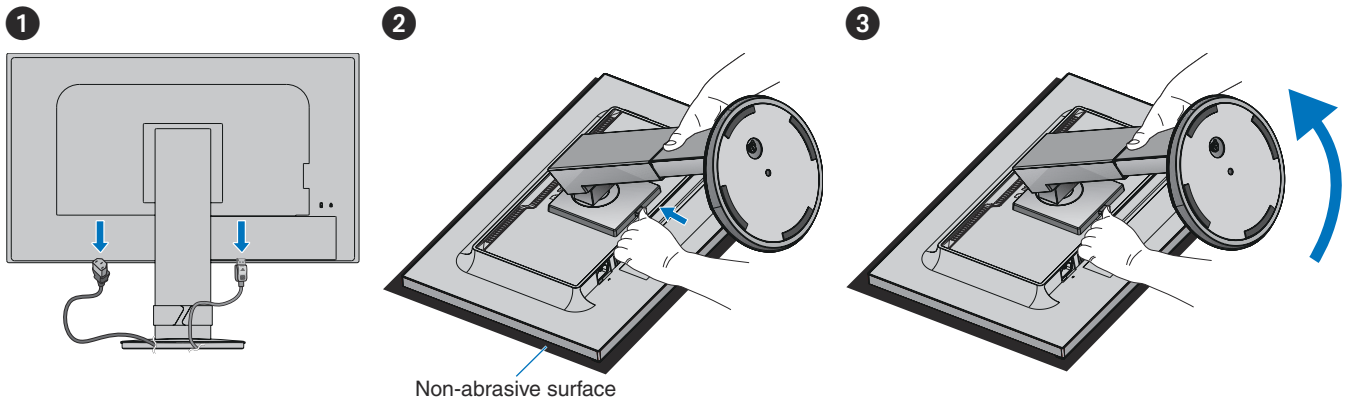

Mount the Flexible Arm

Using four screws that meet the specifications listed below, attach the arm to the monitor.

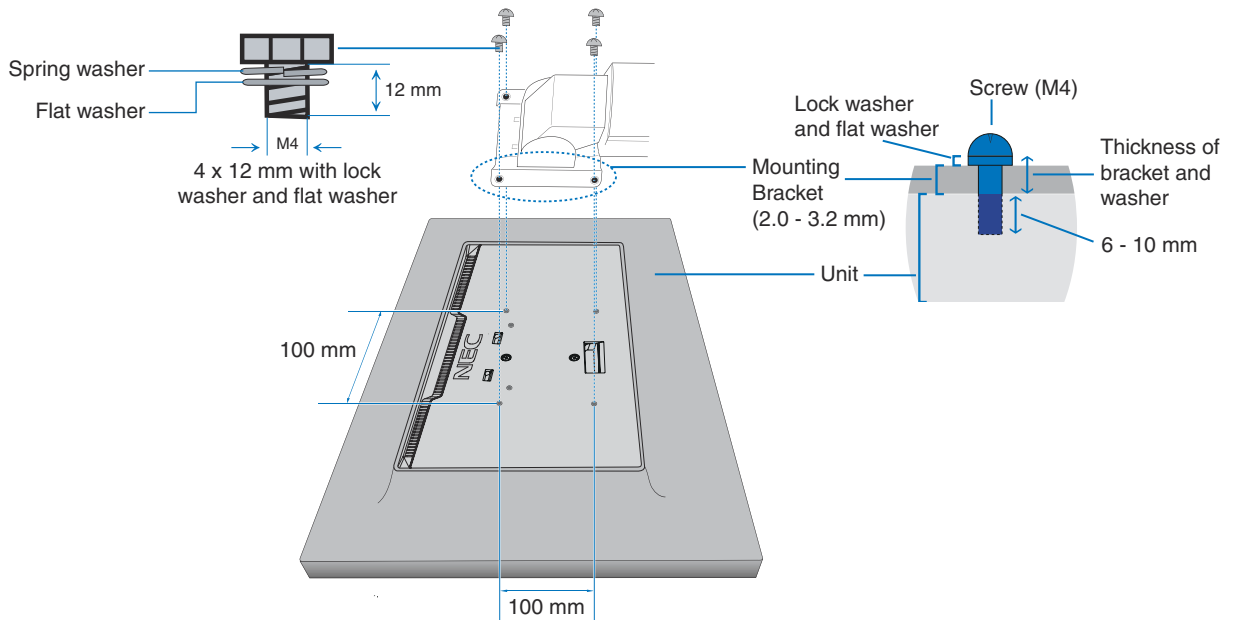

⚠ WARNING: Please refer to "WARNING 8".

ControlSync

ControlSync simultaneously controls all sub monitors connected to a master monitor. It can also individually control a single sub-monitor using the [INDIVIDUAL ADJUST] function. Please refer to the figure below.

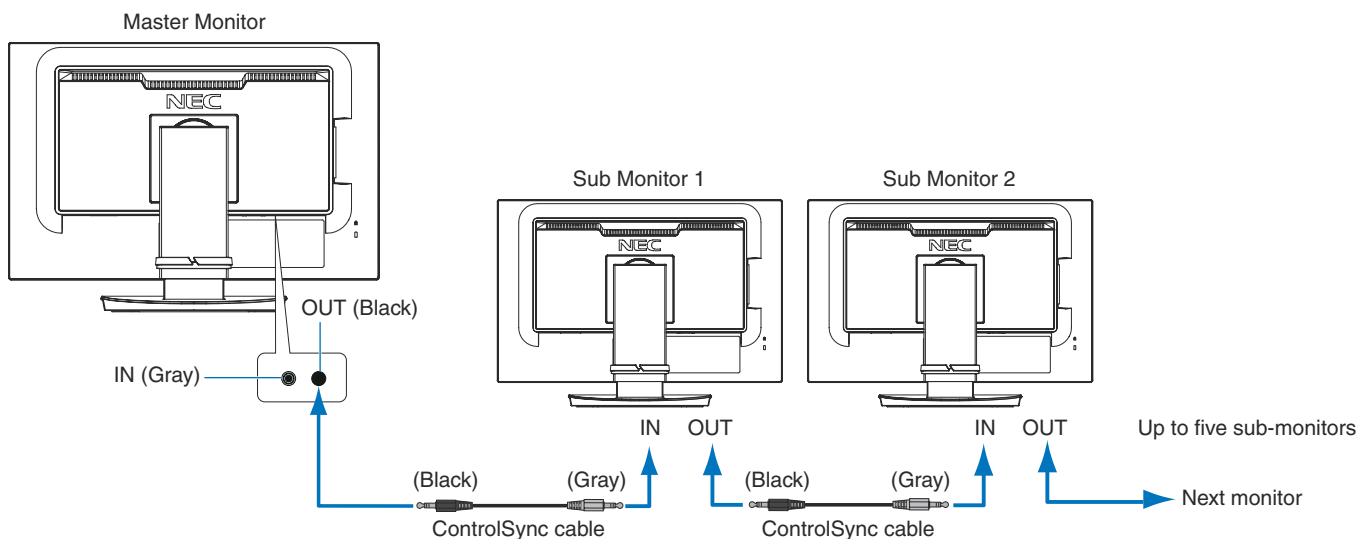

NOTE: The ControlSync icon will appear on the upper left of the OSD menu in the sub-monitors. Do not connect the ControlSync ports IN-to-IN or OUT-to-OUT. The monitors' ControlSync ports must be connected OUT-to-IN.

Do not make a "loop" connection by connecting the last monitor in the chain back to the master monitor.

Turn off the power and disconnect the power cables for all monitors. Connect the

ControlSync cables, then connect the power cables, and then turn on the power for each monitor.

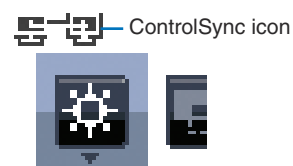

Controlling all connected sub-monitors (Synchronized control):

1. Connect a ControlSync cable (ø 2.5) to the master monitor's ControlSync OUT port and into a sub monitor's ControlSync IN port. Up to five monitors can be daisy-chained together by connecting the monitors to each other via the ControlSync OUT to IN ports on the monitors.
2. Follow the steps for [DATA COPY] (see [page 45](#)). When a setting for the master monitor is adjusted, it will be copied and sent to the connected sub-monitor(s) automatically.

Controlling a target monitor (Individual Adjust):

1. Touch the MENU key to open the OSD menu on the master monitor.
2. Touch the > key to enter the [MULTI DISPLAY] control. When the cursor is on [TARGET MONITOR NO.], a sub-monitor number menu opens. Use the < or > key to select the sub-monitor number. If you touch the INPUT/SELECT key, each sub-monitor displays its monitor number.

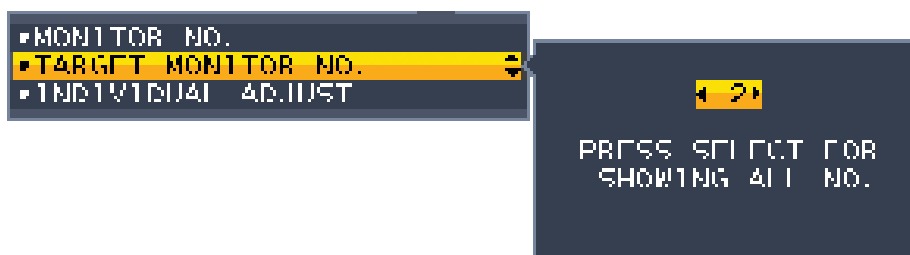

3. Touch the ∨ or ∧ key to select [INDIVIDUAL ADJUST] and then set it to [ON].

Control the sub-monitor's OSD using the master monitor's control keys.

NOTE: To disable [INDIVIDUAL ADJUST], touch the INPUT and MENU keys simultaneously.

The following settings can be controlled by ControlSync:

		Synchronized control	Individual adjust
ECO TOOLS	BRIGHTNESS*	Yes	Yes
	CONTRAST	No	Yes
	ECO MODE	Yes	Yes
	AUTO BRIGHTNESS	Yes	Yes
	BLACK LEVEL	No	Yes
	OFF MODE SETTING	Yes	Yes
	SENSOR SETTING (OFF MODE SETTING)	Yes	Yes
	START TIME (OFF MODE SETTING)	Yes	Yes
	HUMAN SENSING	Yes	Yes
	SENSOR SETTING (HUMAN SENSING)	Yes	Yes
	START TIME (HUMAN SENSING)	Yes	Yes
	DV MODE	Yes	Yes
	SCREEN	AUTO ADJUST	No
AUTO CONTRAST		No	Yes
LEFT/RIGHT		No	Yes
DOWN/UP		No	Yes
H.SIZE		No	Yes
FINE		No	Yes
INPUT RESOLUTION		No	Yes
VIDEO LEVEL		No	Yes
OVER SCAN		No	Yes
EXPANSION		Yes	Yes
RESPONSE IMPROVE		No	Yes
SHARPNESS		No	Yes
COLOR		Color Control System	Yes
	R, G, B, color gain	No	Yes
TOOLS	VOLUME	Yes	Yes
	SOUND INPUT	No	Yes
	VIDEO DETECT	No	Yes
	DP OUT MULTISTREAM	No	Yes
	OFF TIMER	Yes	Yes
	POWER SAVE TIMER	No	Yes
	LED BRIGHTNESS	Yes	Yes
	DDC/CI	Yes	Yes
	USB FUNCTIONALITY	No	Yes
	USB SELECTION	No	Yes
MENU TOOLS	FACTORY PRESET	No	Yes
	LANGUAGE	Yes	Yes
	OSD TURN OFF	Yes	Yes
	OSD LOCK OUT	Yes	Yes
	OSD ROTATION	No	Yes
	HOT KEY	Yes	Yes
	SIGNAL INFORMATION	Yes	Yes
	SENSOR INFORMATION	Yes	Yes
	KEY GUIDE	Yes	Yes
	DATA COPY	No	No
MULTI DISPLAY	CUSTOMIZE SETTING	No	Yes
	MONITOR NO.	No	No
	TARGET MONITOR NO.	No	No
ECO INFORMATION	INDIVIDUAL ADJUST	No	No
	CARBON SAVINGS	No	No
	CARBON USAGE	No	No
	COST SAVINGS	No	No
	CARBON CONVERT SETTING	Yes	Yes
	CURRENCY SETTING	Yes	Yes
	CURRENCY CONVERT SETTING	Yes	Yes

Other settings:

- Power Control (DC switch)
- Ambient Light Sensor
- Human Sensor Result
- Audio Mute

NOTE: Only the master monitor's human sensor and ambient light sensor are active. Please do not cover these sensors (see [page 12](#)).

After connecting all power cords and ControlSync cables, check that ControlSync operates correctly by turning the master monitor's power off then back on.

Do not use the ControlSync connectors for any purpose other than specified.

* This value is not a directly adjusted output value. This is adjusted relatively.

Multiple monitors connection using DisplayPort

You can daisy-chain monitors to each other using the DisplayPort OUT/IN or USB-C connections on the monitors. For using connected monitors in MST (multi-stream transport) mode, the setting should be DP OUT MULTISTREAM "AUTO" for each monitor. Please change the setting for the monitor that connects to the computer last. If the monitors do not display an image, turn off the monitor connected to the computer then turn it back on. Configuring the DisplayPort connections may be necessary. Please refer to the table below and change the settings as needed.

OSD (see page 42)	
DP OUT MULTISTREAM "CLONE"	Factory setting. DisplayPort 1.1a setting with: – SST (single-stream transport).
DP OUT MULTISTREAM "AUTO"	DisplayPort 1.2 setting with: – SST (single-stream transport) and MST (multi-stream transport).

Depending on the display adapter settings in the operating system for the connected computer, the image may not extend. Please refer to the user instructions for the computer to change the settings.

NOTE: Use the DisplayPort cables included with the monitors to connect the monitors to each other. We strongly recommend using the same monitor model for all monitors in the connected daisy-chain. Remove the cap from the DisplayPort OUT connector on the monitor. Please contact your display adapter supplier for detailed information.

	BIT RATE	Maximum number of connectable monitors
MST (multi-stream transport)	HBR2 (Default setting)	4 units (HDCP contents: 4 units)
	HBR	2 units (HDCP contents: 2 units)

NOTE: The number of monitors that can daisy-chain, from a single connection to the computer, depends on the display adapter capabilities and its settings. Please refer to the user instructions for the computer or display adapter.

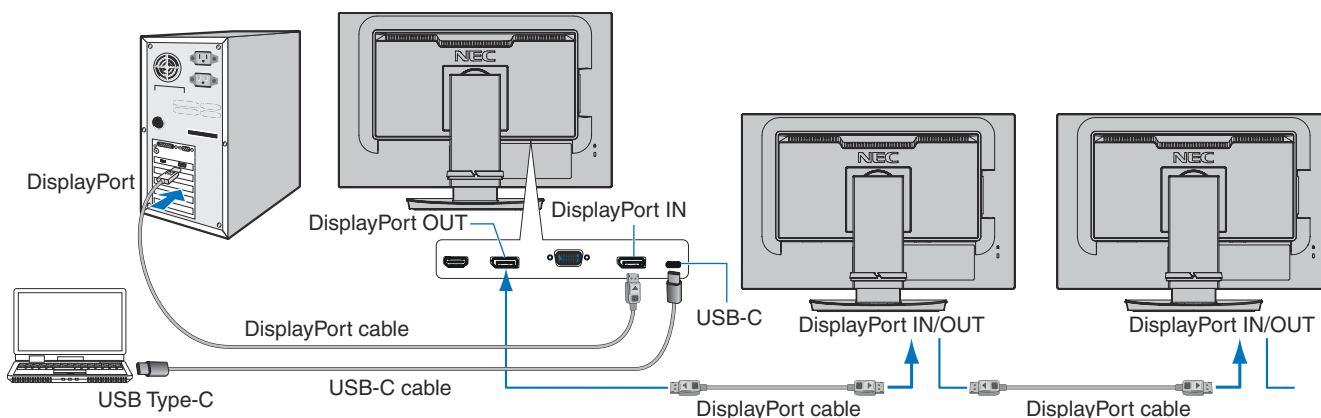

NOTE:

- When the monitor has no image, follow the troubleshooting step "Recovering from no image" on page 24 and select DP VER [1.1].
- When set the MST function is selected, the power management function according to the ErP directive doesn't work.
- If a signal is sent to the USB-C input that is beyond the recommended signal timings, even if the device complies with USB3.1 Gen.1, it might connect as USB2.0. In this case, the USB hub is disconnected temporarily when changing between USB3.1 Gen.1 and USB2.0.
- The USB hub is disconnected temporarily when changing the setting of SST (Single-Stream Transport) to MST (Multi-Streaming Transport). Please remove the USB device before changing the setting. If displaying images in multi-stream, please refer to [DP OUT MULTISTREAM] (see page 42).

Recovering from no image

If the monitors do not display an image after configuring DP OUT MULTISTREAM, please follow the instructions below:

1. Turn off the computer.
2. Touch the MENU key to open the [NO SIGNAL] OSD menu.
3. Touch the ▼ key to open the [VIDEO INPUT] menu.
4. Touch the ^ or ▼ to open the DisplayPort switch menu.
5. Select [DP VER] [1.1] to switch the DisplayPort setting.
6. Touch the MENU key to close the OSD menu.
7. Turn on the computer.



NOTE: MST (multi-stream transport) and SST (single-stream transport) requires a corresponding display adapter. Check to make sure that the display adapter supports MST (multi-stream transport). Please refer to the user instructions for the computer to change the settings.

NOTE: Use the DisplayPort cables included with the monitors to connect the monitors to each other.

This Chapter Includes:

- ⇒ “Using the OSD (On-Screen Display) Controls” on page 26
- ⇒ “Changing the Input” on page 27
- ⇒ “Power management function LED indicator patterns” on page 27

Using the OSD (On-Screen Display) Controls

OSD (On-Screen Display) control key on the front of the monitor function as follows:

- To access the OSD menu, touch the MENU key.



Below is a brief summary of where controls are under each menu item. Tables listing all options available in the OSD menu are located in [“Appendix A OSD Controls List” on page 38.](#)



ECO TOOLS: Set environment friendly ECO settings.



SCREEN: Set screen settings.



COLOR: Set color settings.



TOOLS: Set volume, sound input, etc.



MENU Tools: Set language, signal information, etc.



MULTI DISPLAY: Set monitor no., target monitor no., and individual adjust.



ECO INFORMATION: Displays information related to ECO.



Information: Displays monitor information such as input, resolution, etc.

Changing the Input

Changing the Input

To change the signal input, press the **Input** key.

For HDCP Content

HDCP is a system for preventing illegal copying of video data sent over a digital signal. If you are unable to view material via the digital inputs, this does not necessarily mean that the monitor is not functioning properly. With the implementation of HDCP, there may be cases in which certain content is protected by HDCP and might not be displayed due to the decision/intention of the HDCP community (Digital Content Protection, LLC). HDCP video content is generally commercially produced Blu-rays and DVDs, television broadcast, and streaming media services.

Power management function LED indicator patterns

The power management function is an energy saving feature that automatically reduces the power consumption of the monitor when the keyboard or the mouse has not been used for a fixed period.

Mode	LED indicator	Power consumption	Condition
Maximum operation	Blue	Approx. 118.0 W	All functions work.
Normal operation	Blue	Approx. 19.0 W	Default setting.
Energy saving mode	Amber	0.30 W	The monitor has passed a certain amount of time with no video signal input.
Off mode	Off	0.25 W	Turn off the monitor by the \odot key.

- NOTE:**
- Power consumption depends on the setting of OSD or which devices are connected to the monitor.
 - This function works with computers that support VESA approved DPM (Display Power Management).

Chapter 3 Troubleshooting

This Chapter Includes:

- ⇒ “Screen Image and Video Signal Issues” on page 29
- ⇒ “Hardware Issues” on page 30
- ⇒ “Image Persistence” on page 32
- ⇒ “Human Sensing function” on page 33
- ⇒ “Using the Auto Brightness function” on page 34

Screen Image and Video Signal Issues

No picture

- Make sure the signal cable is fully connected to the monitor and the computer.
- Make sure the computer's display card is fully seated in its slot.
- Make sure there is no DisplayPort converter adapter connected. The monitor does not support DisplayPort converter adapter.
- Make sure both the computer and monitor are powered on.
- The monitor may be in power saving mode. The monitor automatically goes into standby at the preset time period after the video signal is lost. Press the  button on the monitor.
- Make sure that a supported resolution has been selected on the display card or system being used. If in doubt, please refer to the user's manual of the display controller or system to change the resolution.
- Check the monitor and your display card with respect to compatibility and recommended settings.
- Check the signal cable connector for bent or pushed-in pins.
- Make sure the connected device outputs a signal to the monitor.
- If the front LED is dark blue, check the status of the [OFF MODE SETTING] mode (see [page 39](#)) or [HUMAN SENSING] (see [page 40](#)).
- When using a USB USB-C cable for connecting a computer to the monitor, please check that the connected computer's port complies with DisplayPort Alt Mode.
- When using a USB-C cable for connecting a computer to the monitor, check that the USB-C cable complies with SuperSpeed USB 10Gbps (USB 3.1 Gen 2).

Selected resolution is not displayed properly

- If the resolution you set is over or under a range, "OUT OF RANGE" window will appear then warn you. Please set supported resolution at the connected computer.

The image is unstable, unfocused or swimming is apparent

- Make sure the signal cable is fully connected to the monitor and the computer.
- Use the OSD Image Adjust controls to focus and adjust the display by increasing or decreasing the [FINE] adjustment. When the display mode is changed, the OSD Image Adjust settings may need to be readjusted.
- Check the monitor and your display card with respect to compatibility and recommended signal timings.
- If your text is garbled, change the video mode to non-interlace and use the 60Hz refresh rate.

Picture is not bright

- If the brightness fluctuates, make sure [DV MODE] is set to [STANDARD].
- Make sure [ECO MODE] and [AUTO BRIGHTNESS] are turned off.
- If the brightness fluctuates, make sure [AUTO BRIGHTNESS] is turned off.
- Make sure the signal cable is fully connected to the monitor and the computer.
- LCD brightness degradation occurs due to long-term usage or extreme cold conditions.
- When using an HDMI input, please change [VIDEO LEVEL].

Display image is not sized properly

- Use the OSD Image Adjust controls to increase or decrease the Coarse adjustment.
- Make sure that a Major Supported Timings has been selected for the display card in the system being used. (Please consult the manual for the system or display card for supported resolution and changing the settings.)
- When using an HDMI input, please change [OVER SCAN].

Brightness variations over time

- Change [AUTO BRIGHTNESS] to [OFF] and then adjust the [BRIGHTNESS].
- Change [DV MODE] to [STANDARD] and then adjust the [BRIGHTNESS].

NOTE: When [AUTO BRIGHTNESS] is set to [ON], the monitor automatically adjusts brightness based on the environment. When the brightness of surrounding environment changes, the monitor will also change.
When [DV MODE] is set to [DYNAMIC], the monitor automatically adjusts brightness based on the video signal.

Displayed OSD menu is rotated

- Make sure of the [OSD ROTATION] setting.

No picture in multiple monitor connection

- Check to make sure that the resolution is lower than the recommended resolution setting.
- Check to make sure that the display card supports MST (multi-stream transport).
- The number of monitors daisy chained through SST (single-stream transport) depends on HDCP contents limitation.
- Monitors should be connected by the included DisplayPort cable.

Hardware Issues

⏻ Key does not respond

- Unplug the power cord of the monitor from the AC outlet to turn off and reset the monitor.

LED on monitor is not lit (no blue or amber color can be seen)

- Make sure the power cord is properly connected to the monitor and the wall, and make sure the monitor's power switch is on.
- Increase the [LED BRIGHTNESS] adjustment.

No Video

- If no video is present on the screen, turn the ⏻ key off and on again.
- Make sure the computer is not in a power-saving mode by touching the connected keyboard or the connected mouse.
- When using DisplayPort, some display cards do not output video signal under low resolution modes when the monitor is turned OFF/ON or disconnected/connected from the AC power cord.
- When using an HDMI input, please change [OVER SCAN].
- Make sure [VIDEO DETECT] is set to [NONE].
- Make sure [USB FUNCTIONALITY] is set to [ON] or [AUTO].

No Sound

- Check to see if the speaker cable is properly connected.
- Check to see if [MUTE] is activated.
- Check to see if [VOLUME] is set to a minimum.
- Check to see if the computer supports an audio signal through DisplayPort, HDMI or USB-C.
- Check selected [SOUND INPUT] when DisplayPort, HDMI or USB-C is in use.

The USB Hub does not operate

- Check to make sure that the USB cable is properly connected. Refer to your USB device User's Manual.
- Check that the USB upstream port on the monitor is connected to the USB downstream port on the computer, and make sure the computer is ON.
- Make sure the USB-C cable is properly connected.
- Check the [USB SELECTION] settings.
- Turn the main power switch off and on again.

Human sensor does not work

- Make sure there is no object in front of the Human sensor.
- Make sure there is no equipment that radiates infrared rays in front of the monitor.

ControlSync does not work

- Make sure the ControlSync cable is connected correctly.
- Make sure the ControlSync cable is not in "loop" connection.
- Master monitor should be connected with ControlSync OUT connector only.
- Please use the provided ControlSync cables.
- You can use up to five sub monitors via ControlSync.

USB Type-C device does not work

"Warning: Remove USB-C cable" OSD was shown.

- The monitor detected abnormal voltage or current on USB-C port. Please remove USB-C cable immediately.

No picture

- Make sure [USB FUNCTIONALITY] is set to [ON] or [AUTO].
- Check if the connected USB-C device complies with DisplayPort Alt Mode on USB Type-C.
- Check if the USB-C cable complies with USB 3.1 Gen.1 or Gen.2.

Charging is not started or unstable.

- Make sure [USB FUNCTIONALITY] is set to [ON] or [AUTO].
 - Check if the connected USB-C device complies with USB Power Delivery.
 - Check if the USB-C cable complies with USB Power Delivery.
 - The monitor might have excessive voltage or over current on USB-C port. Please remove the USB-C cable immediately.
- If you still have trouble, unplug the monitor's power cord from the AC outlet and then remove the USB-C cable. Reconnect the power cord and then the USB-C cable.

Image Persistence

Please be aware that LCD Technology may experience a phenomenon known as Image Persistence. Image Persistence occurs when a residual or “ghost” image of a previous image remains visible on the screen. Unlike CRT monitors, the image persistence on LCD monitors is not permanent, but single still image being displayed for a long period of time should be avoided.

To alleviate image persistence, turn off the monitor for as long as the previous image was displayed. For example, if an image was on the monitor for one hour and a residual image remains, the monitor should be turned off for one hour to erase the image.

NOTE: As with all personal display devices, NEC DISPLAY SOLUTIONS recommends using a moving screen saver at regular intervals whenever the screen is idle, or turning off the monitor when not in use.

Human Sensing function

The Human Sensing function reduces power consumption by detecting the movement of a person.

The [HUMAN SENSING] has following two settings:

MODE	HUMAN SENSING SETTING	No person in front of the monitor
LIGHT	1	BRIGHTNESS 0 %
DEEP	2	Power saving mode

Image of human sensing operation

- When the sensor detects no person in front of the monitor, the monitor stays on for the period of time which is set at [HUMAN SENSING] → [START TIME] (see [page 40](#)).
- The monitor displays a notification on the screen after the period of time with no human detected has passed. You can set the notification screen at [SENSOR INFORMATION] (see [page 45](#)).

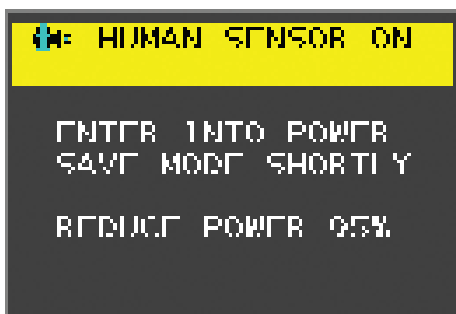

- After displaying the notification, if [LIGHT] is set at [HUMAN SENSING], the monitor screen gets gradually darker until it gets to 0 % brightness. If [DEEP] is set at [HUMAN SENSING], the monitor enters into power saving mode.
- When the sensor detects a person coming back, the monitor is automatically returned from power saving mode to normal mode.

NOTE: When [LIGHT] is set at [HUMAN SENSING], the monitor screen gets gradually brighter as it returns to the original brightness.

- The monitor returns to normal mode.

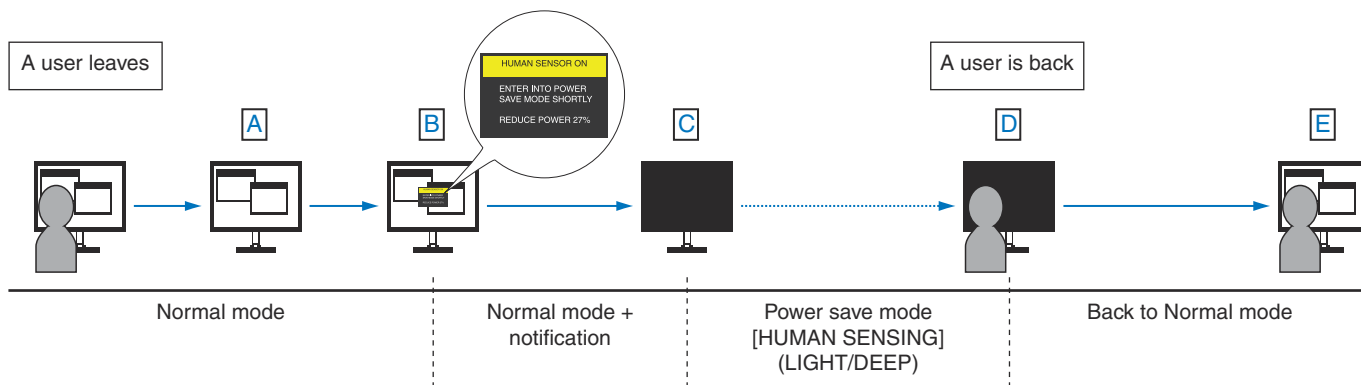

Using the Auto Brightness function

The brightness of the LCD screen can be set to increase or decrease depending on the amount of ambient lighting within the room. If the room is bright, the monitor becomes correspondingly bright. If the room is dim, then the monitor will dim accordingly. The purpose of this function is to make the viewing experience more comfortable to the eye in a variety of lighting conditions.

SETUP

Use the following procedures to select the brightness range the monitor will use when the [AUTO BRIGHTNESS] function is activated.

1. Set a level for the bright room condition. This is the maximum brightness level the monitor will rise to when the ambient lighting level is highest. Configure this setting when the room is at its brightest.

Select [ON] in the [AUTO BRIGHTNESS] menu (**Figure 1**). Then use the front Keys to move the cursor up to the [BRIGHTNESS] setting. Choose the desired brightness level (**Figure 2**).



Figure 1



Figure 2

2. Set a level for the dark room condition. This is the minimum brightness level the monitor will lower to when the ambient lighting level is low. Make sure the room is at its darkest when setting this level.

Then use the front Keys to move the cursor up to the [BRIGHTNESS] setting. Choose the desired brightness level (**Figure 3**).



Figure 3

When the [AUTO BRIGHTNESS] function is enabled the Brightness level of the screen changes automatically according to the lighting conditions of the room (**Figure 4**).

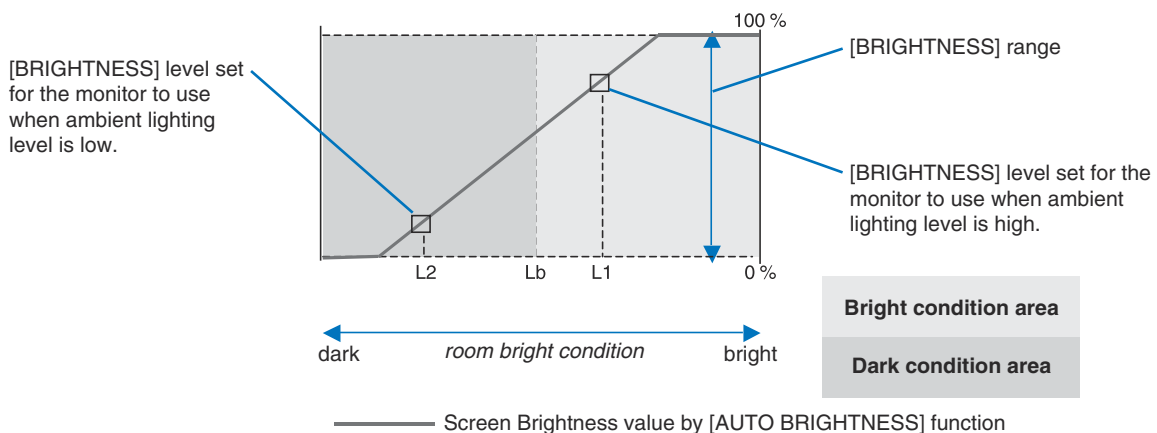

Figure 4

Lb: Border between bright and dim lighting conditions; set at the factory
 L1: [BRIGHTNESS] level set for the monitor to use when ambient lighting level is high ($L1 > Lb$)
 L2 : [BRIGHTNESS] level set for the monitor to use when ambient lighting level is low ($L2 < Lb$)
 L1 and L2 are the brightness levels set by the user to compensate for changes in ambient lighting.

This Chapter Includes:

- ⇒ “EA242F” on page 36
- ⇒ “EA272F” on page 37

EA242F

Monitor Specifications		MultiSync EA242F	Notes
LCD Module	Diagonal: Viewable Image Size: Native Resolution:	60.47 cm/23.8 inches 60.47 cm/23.8 inches 1920 x 1080 60 Hz	Active matrix; thin film transistor (TFT) liquid crystal display (LCD); 0.275 mm (H) x 0.275 mm (V) dot pitch; 250 cd/m ² white luminance; 1000:1 contrast ratio (typical), (5000:1 Contrast ratio, Dynamic).
Input Signal			
VGA:	Mini D-Sub 15-pin:	Analog RGB Sync	0.7 Vp-p/75 ohm Separate sync.TTL level Positive/Negative Composite sync.TTL level Positive/Negative Sync on Green (Video 0.7 Vp-p and Sync Negative 0.3 Vp-p)
DisplayPort:	DisplayPort Connector: USB-C Port:	Digital RGB Digital RGB	Up to 1920 x 1080 60 Hz, 8 bit, DisplayPort V1.2 (HDCP 1.3) Up to 1920 x 1080 60 Hz, 8/10 bit, DisplayPort V1.2 (HDCP 1.3)
HDMI:	HDMI Connector:	Digital RGB/YUV	Up to 1920 x 1080 60 Hz, HDMI (HDCP 1.4)
Output Signal			
DisplayPort:	DisplayPort Connector:	Digital RGB	DisplayPort Complies with Standard V1.2, applicable to HDCP
Display Colors		16777216	Depends on display card used.
Synchronization Range	Horizontal: Vertical:	31.5 kHz to 83.0 kHz 50 Hz to 75 Hz	Automatically Automatically
Viewing Angle	Left/Right: Up/Down:	±89° (CR > 10) ±89° (CR > 10)	
Response Time		6 ms (Gray to Gray Typ.)	
Active Display Area	Landscape: Horiz.: Vert.: Portrait: Horiz.: Vert.:	527.0 mm/20.7 inches 296.5 mm/11.7 inches 296.5 mm/11.7 inches 527.0 mm/20.7 inches	
USB Hub	I/F: Port: Load Current:	SuperSpeed USB (USB 3.1 Gen 1) Upstream 2 (USB-C Port) Downstream 3 Downstream Port: 5V/0.9A (Max.) USB-C Port: 65 W (Max.)	
AUDIO			
AUDIO Input:	STEREO Mini Jack: DisplayPort Connector: USB-C Port (DisplayPort Alt. Mode): HDMI Connector:	Analog Audio Digital Audio Digital Audio Digital Audio	Stereo L/R 500mV rms 20 Kohm PCM 2ch 32, 44.1, 48 kHz (16/20/24bit) PCM 2ch 32, 44.1, 48 kHz (16/20/24bit) PCM 2ch 32, 44.1, 48 kHz (16/20/24bit)
Headphone Output:	STEREO Mini Jack:		Headphone Impedance 32 Ohm
Speakers	Practical Audio Output:	1.0 W + 1.0 W	
ControlSync (available up to 5 sub monitors)	IN: OUT:	Stereo Micro jack 2.5 φ Stereo Micro jack 2.5 φ	
Power Supply		AC 100-240 V, 50/60 Hz	
Current Rating		1.40 - 0.70 A	
Dimensions	Landscape: Portrait:	537.7 mm (W) x 336.2 - 486.2 mm (H) x 250.0 mm (D) 21.2 inches (W) x 13.2 - 19.1 inches (H) x 9.8 inches (D) 319.1 mm (W) x 555.4 - 615.4 mm (H) x 250.0 mm (D) 12.6 inches (W) x 21.9 - 24.2 inches (H) x 9.8 inches (D)	
Stand adjustable range	Height Adjustment: Tilt / Pivot / Swivel:	150 mm/5.91 inches (Landscape orientation) 60 mm/2.36 inches (Portrait orientation) Up 35° Down 5° / ± 90° / 340°	
Weight		7.0 kg (15.4 lbs) (with monitor stand)/4.5 kg (9.9 lbs) (without monitor stand)	
Environmental Considerations			
	Operating Temperature: Humidity: Altitude:	5°C to 35°C/41°F to 95°F 20 % to 80 % 0 to 16,404 Feet/0 to 5,000 m	
	Storage Temperature: Humidity: Altitude:	-10°C to 60°C/14°F to 140°F 10 % to 85 % 0 to 40,000 Feet/0 to 12,192 m	

NOTE: Technical specifications are subject to change without notice.

Monitor Specifications		MultiSync EA272F	Notes
LCD Module	Diagonal: Viewable Image Size: Native Resolution:	68.6 cm/27 inches 68.6 cm/27 inches 1920 x 1080 60 Hz	Active matrix; thin film transistor (TFT) liquid crystal display (LCD); 0.311 mm (H) x 0.311 mm (V) dot pitch; 250 cd/m ² white luminance; 1000:1 contrast ratio (typical), (5000:1 Contrast ratio, Dynamic).
Input Signal			
VGA:	Mini D-Sub 15-pin:	Analog RGB Sync	0.7 Vp-p/75 ohm Separate sync.TTL level Positive/Negative Composite sync.TTL level Positive/Negative Sync on Green (Video 0.7 Vp-p and Sync Negative 0.3 Vp-p)
DisplayPort:	DisplayPort Connector: USB-C Port:	Digital RGB Digital RGB	Up to 1920 x 1080 60 Hz, 8 bit, DisplayPort V1.2 (HDCP 1.3) Up to 1920 x 1080 60 Hz, 8/10 bit, DisplayPort V1.2 (HDCP 1.3)
HDMI:	HDMI Connector:	Digital RGB/YUV	Up to 1920 x 1080 60 Hz, HDMI (HDCP 1.4)
Output Signal			
DisplayPort:	DisplayPort Connector:	Digital RGB	DisplayPort Complies with Standard V1.2, applicable to HDCP
Display Colors		16777216	Depends on display card used.
Synchronization Range	Horizontal: Vertical:	31.5 kHz to 83.0 kHz 50 Hz to 75 Hz	Automatically Automatically
Viewing Angle	Left/Right: Up/Down:	±89° (CR > 10) ±89° (CR > 10)	
Response Time		6 ms (Gray to Gray Typ.)	
Active Display Area	Landscape: Horiz.: Vert.: Portrait: Horiz.: Vert.:	597.9 mm/23.5 inches 336.3 mm/13.2 inches 336.3 mm/13.2 inches 597.9 mm/23.5 inches	
USB Hub	I/F: Port: Load Current:	SuperSpeed USB (USB 3.1 Gen 1) Upstream 2 (USB-C Port) Downstream 3 Downstream Port: 5V/0.9A (Max.) USB-C Port: 65 W (Max.)	
AUDIO			
AUDIO Input:	STEREO Mini Jack: DisplayPort Connector: USB-C Port (DisplayPort Alt. Mode): HDMI Connector:	Analog Audio Digital Audio Digital Audio Digital Audio	Stereo L/R 500mV rms 20 Kohm PCM 2ch 32, 44.1, 48 kHz (16/20/24bit) PCM 2ch 32, 44.1, 48 kHz (16/20/24bit) PCM 2ch 32, 44.1, 48 kHz (16/20/24bit)
Headphone Output:	STEREO Mini Jack:		Headphone Impedance 32 Ohm
Speakers	Practical Audio Output:	1.0 W + 1.0 W	
ControlSync (available up to 5 sub monitors)	IN: OUT:	Stereo Micro jack 2.5 φ Stereo Micro jack 2.5 φ	
Power Supply		AC 100-240 V, 50/60 Hz	
Current Rating		1.40 - 0.70 A	
Dimensions	Landscape: Portrait:	610.2 mm (W) x 376.9 - 526.9 mm (H) x 250.0 mm (D) 24.0 inches (W) x 14.8 - 20.7 inches (H) x 9.8 inches (D) 359.8 mm (W) x 628.0 - 651.6 mm (H) x 250.0 mm (D) 14.2 inches (W) x 24.7 - 25.7 inches (H) x 9.8 inches (D)	
Stand adjustable range	Height Adjustment: Tilt / Pivot / Swivel:	150 mm/5.91 inches (Landscape orientation) 23.6 mm/0.93 inches (Portrait orientation) Up 35° Down 5° / ± 90° / 340°	
Weight		9.2 kg (20.3 lbs) (with monitor stand)/5.8 kg (12.8 lbs) (without monitor stand)	
Environmental Considerations			
	Operating Temperature: Humidity: Altitude:	5°C to 35°C/41°F to 95°F 20 % to 80 % 0 to 16,404 Feet/0 to 5,000 m	
	Storage Temperature: Humidity: Altitude:	-10°C to 60°C/14°F to 140°F 10 % to 85 % 0 to 40,000 Feet/0 to 12,192 m	

NOTE: Technical specifications are subject to change without notice.

Appendix A OSD Controls List

This Chapter Includes

- ⇒ “ECO TOOLS” on page 39
- ⇒ “SCREEN” on page 40
- ⇒ “COLOR” on page 42
- ⇒ “TOOLS” on page 42
- ⇒ “MENU TOOLS” on page 43
- ⇒ “MULTI DISPLAY” on page 45
- ⇒ “ECO INFORMATION” on page 46
- ⇒ “INFORMATION” on page 46
- ⇒ “OSD Warning” on page 46

Default values can be provided on request.

ECO TOOLS Menu	
BRIGHTNESS	Adjusts the overall image and background screen brightness. If [ECO MODE] is set to [1] or [2], a bar for [CARBON FOOTPRINT] will appear.
CONTRAST	Adjusts the overall image and background screen brightness by input signal level. NOTE: This function is disabled when [L/B] is selected in the Color Control System.
ECO MODE	Decreases the amount of power consumption by reducing the brightness level. NOTE: This function is disabled when [DV MODE] (see page 40) is set to [DYNAMIC]. This function is disabled when Color Control System is set to [DICOM SIM.]. To enter the [ECO MODE], touch the ECO key. When you touch the ECO key, the setting cycles through [1] → [2] → [OFF] → [1].
OFF	Does not function.
1	Sets the brightness variable range from 0% to 80 %. This setting can adjust brightness to a range in which power is reduced by 15 % compared to the maximum brightness setting.
2	Sets the brightness variable range from 0% to 30 %. This setting can adjust brightness to a range in which power is reduced by 35 % (EA242F)/40 % (EA272F) compared to the maximum brightness setting. When this function is set to [ON], a [CARBON FOOTPRINT] bar will appear alongside the [BRIGHTNESS] adjustment bar.
AUTO BRIGHTNESS	Automatically adjusts the brightness. NOTE: This function is disabled when [DV MODE] is set to [DYNAMIC]. This function is disabled when Color Control System is set to [DICOM SIM.].
OFF	Does not function.
ON (AMBIENT LIGHT)	Adjusts the brightness to the optimal setting by detecting the brightness level of the environment.*1
BLACK LEVEL	Adjusts the brightness level of black when displayed on screen.
OFF MODE SETTING	The Intelligent Power Manager allows the monitor to enter into power saving mode after a period of inactivity.
OFF	The monitor enters into power saving mode automatically when the input signal is lost.
ON	The monitor enters into power saving mode automatically when the amount of surrounding light goes below the level determined by you. The level can be adjusted in the [OFF MODE SENSOR SETTING]. When in power saving mode, the LED on the front of the monitor becomes dark blue. When in power saving mode, touch any of the front keys, except for  and INPUT keys, to return to normal mode. When the amount of surrounding light returns to normal levels, the monitor will automatically return to normal mode.
SENSOR SETTING (OFF MODE SETTING)	Adjusts the threshold level for the ambient light sensor for detecting low light conditions and shows the current sensor measurement result.
START TIME (OFF MODE SETTING)	Adjusts the wait time to enter into a lower power consumption level when the ambient light sensor detects low light conditions.

*1: Please refer to [page 34](#) for full "Auto Brightness" information.

ECO TOOLS Menu	
HUMAN SENSING	The sensor detects the movement of a person by using the [HUMAN SENSING] function. The [HUMAN SENSING] function has three settings. NOTE: Detects a person within about 1.5 m from the monitor.
OFF	Does not function.
1 (LIGHT)	After it detects that there is no person during a period of time, the monitor shifts to low brightness mode automatically to reduce the power consumption. When a person comes near the monitor again, the monitor will automatically return to normal mode. [START TIME] adjusts the period of time to wait before entering low brightness mode.
2 (DEEP)	After it detects that there is no person, the monitor shifts to power saving mode automatically to reduce the power consumption. When a person comes near the monitor again, it resumes from the power saving mode.
SENSOR SETTING (HUMAN SENSING)	Adjusts the threshold level of [HUMAN SENSING]. When the human icon is located on the right side of the white color bar or vermilion color wave, a person is not detected. NOTE: The [HUMAN SENSING] function starts after the OSD menu is closed.
START TIME (HUMAN SENSING)	Adjusts the wait time before entering to low brightness mode or power saving mode when the Human Sensor detects no person.
DV MODE	Dynamic Visual Mode allows you to select from the following settings: NOTE: This function is disabled when Color Control System is set to [L/B], [PROGRAMMABLE] or [DICOM SIM.]. [STANDARD] is used for TCO Certificate compliance.
STANDARD	Standard setting.
TEXT	Setting that makes letters and lines crisp; best suited for basic word processing and spreadsheets.
MOVIE	Setting that boosts dark tones; best suited for movies.
GAMING	Setting that boosts whole tones; best suited for games that use vivid, colorful images.
PHOTO	Setting that optimizes contrast; best suited for still images.
DYNAMIC	Setting that adjusts the brightness by detecting the screen's black areas and optimizes it.

SCREEN

SCREEN Menu	
AUTO ADJUST Analog input only	Automatically adjusts the image position, the [H.SIZE] and [FINE] settings.
AUTO CONTRAST Analog input only	Adjusts the image displayed for non-standard video inputs.
LEFT/RIGHT Analog input only	Controls horizontal image position within the display area of the LCD.
DOWN/UP Analog input only	Controls vertical image position within the display area of the LCD.

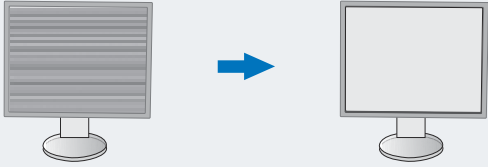
SCREEN Menu	
H.SIZE Analog input only	<p>Adjusts the horizontal size by increasing or decreasing the setting.</p> <p>If the [AUTO ADJUST] function does not give you a satisfactory picture setting, additional tuning can be performed by using the [H.SIZE] function (dot clock). A Moiré test pattern can be used for this. This function may alter the width of the picture. Use the < or > key to center the image on the screen. If the [H.SIZE] is incorrectly calibrated, the result would look like the left drawing. The image should be homogeneous.</p>  <p>When [H.SIZE] value is wrong. When [H.SIZE] value is improved. When [H.SIZE] value is correct.</p>
FINE Analog input only	<p>Improves focus, clarity and image stability by increasing or decreasing the setting.</p> <p>If the [AUTO ADJUST] and [H.SIZE] functions do not give you a satisfactory picture setting, fine tuning can be performed by using the [FINE] function.</p> <p>A Moiré test pattern can be used for this. If the [FINE] value is incorrectly calibrated, the result would look like the left drawing. The image should be homogeneous.</p>  <p>When [FINE] value is wrong. When [FINE] value is correct.</p>
INPUT RESOLUTION Analog input only	<p>Selects one of the following pair of resolutions as the input signal priority:</p> <p>[1360 x 768] or [1280 x 768] or [1024 x 768] (vertical resolution 768), [1600 x 900] or [1280 x 960] (horizontal frequency 60kHz), [1680 x 1050] or [1400 x 1050] (vertical resolution 1050).</p>
VIDEO LEVEL HDMI input only	
NORMAL	Setting for use with a computer. Displays all input signals of 0-255 steps.
EXPAND	Setting for use with audio visual equipment. Expands input signals of 16-235 steps to 0-255 steps.
OVER SCAN HDMI input only	Some video formats may require different scanning modes in order to best display the image.
ON	Image size is larger than what can be displayed. The image edge will appear cropped. Approximately 95 % of the image will be shown on the screen.
OFF	Image size stays within the display area. The whole image is displayed on the screen.
EXPANSION	Sets the zoom method.
FULL	The image is expanded to full screen regardless of the resolution.
ASPECT	The image is expanded without changing the aspect ratio.
RESPONSE IMPROVE	Turns the [RESPONSE IMPROVE] function [ON] or [OFF]. This function may reduce blurring that occurs in some moving images.
SHARPNESS	Adjusts the crispness of the image.

COLOR

COLOR Menu	
Color Control System	Color presets are available for adjusting color settings.
1, 2, 3, 4, 5	Increases or decreases the [RED], [GREEN] or [BLUE] color depending upon which is selected. The change in color will appear on screen and the direction (increase or decrease) will be shown by the bars. sRGB (color preset mode [4]) dramatically improves the color fidelity in the desktop environment by a single standard RGB color space. With this color-supported environment, the operator could easily and confidently communicate color without further color management overhead in most common situations.
NATIVE	The LCD panel's original colors that cannot be adjusted.
L/B (LOW BLUE LIGHT)	Reduces blue light emitted from monitor. This item cannot be adjusted. NOTE: You can directly change to [L/B] (LOW BLUE LIGHT) mode by touching the INPUT key for 3 seconds or more. For changing to other settings from [L/B] mode, touch the MENU key to show OSD menu and enter Color Control System. When [L/B] is selected in Color Control System, [CONTRAST] and [DV MODE] are disabled.
DICOM SIM.	The white point color temperature and the gamma curve are set to a DICOM simulation. This item cannot be adjusted.
PROGRAMMABLE	The gamma curve is adjustable through application software. NOTE: When [MOVIE], [GAMING] or [PHOTO] is selected as the [DV MODE], [NATIVE] is selected automatically and cannot be changed.

TOOLS

TOOLS Menu	
VOLUME	Controls the volume of the speakers or headphones. To mute the speaker output touch the ECO/RESET key.
SOUND INPUT HDMI, DisplayPort, USB-C inputs only	Selects the sound input source.
VIDEO DETECT	Selects the method of video detection when more than one video input is connected.
FIRST	When the current video input signal is not present, the monitor searches for a video signal from the other video input ports. If the video signal is present in another port, the monitor switches the video source input to the detected video source automatically. The monitor will not look for other video signals while the current video source is present.
NONE	Video input signal detection is not enabled.
DP OUT MULTISTREAM	Selects the DisplayPort mode. NOTE: When the monitor has no image, refer to "Multiple monitors connection using DisplayPort" on page 23.
CLONE	Sets SST (single-stream transport). Default is [CLONE].
AUTO	Displays in SST (single-stream transport) or MST (multi-stream transport) mode. [AUTO] should be selected when using MST (multi-stream transport).* If multiple monitors are set to [SST], an individual image is displayed at each monitor. *: MST (multi-stream transport) and SST (single-stream transport) require the computer display adapter supports the feature. Please refer to the user instructions for the computer or display adapter.

TOOLS Menu	
OFF TIMER	The monitor will automatically power off after a period of time has passed, which you can set. Before powering off, a message will appear on the screen asking if you want to delay the turn off time by 60 minutes. Touch any OSD key to delay the power-down time.
POWER SAVE TIMER	Allows the monitor to turn off automatically after 2 consecutive hours in power save mode.
LED BRIGHTNESS	Adjusts the Power LED brightness.
DDC/CI	Turns the [DDC/CI] function [ON] or [OFF].
USB FUNCTIONALITY	Selects how power through the USB Type-A port and USB Type-C port, input signal from USB-C, and external communication of USB are enabled in relation to the monitor's power status. NOTE: Actual power consumption depends on the connected USB device even when the monitor's power is off. To avoid data loss, before changing the setting, ensure that no USB storage devices are in use by the operating system.
AUTO	Depending on the monitor's power condition.
ON	Always working even when the monitor is in power save mode or power off.
OFF	All USB functions (include USB Type-C video signal) are disabled.
USB SELECTION	Change the USB upstream input (USB or USB-C) associated with the current display input. When connecting a computer to each of the upstream ports, the monitor's USB downstream ports can be used by selecting this setting for the current input signal. You can change the active display and upstream USB port combination by using the INPUT key (see page 12). When using only one upstream port, the connected upstream port is used by default. NOTE: To avoid data loss, before changing USB upstream ports, ensure that no USB storage devices are in use by the operating system of the computer attached to the USB upstream port.
FACTORY PRESET	Selecting [FACTORY PRESET] allows you to reset all OSD control settings back to the factory settings except [LANGUAGE] and [OSD LOCK OUT]. Individual settings can be reset by touching the ECO/RESET key.

MENU TOOLS

MENU TOOLS Menu	
LANGUAGE	Selects the language used by the OSD.
OSD TURN OFF	The OSD menu will stay open as long as it is in use. You can select how long the monitor waits after the last key touch to close the OSD menu. The preset choices are 10-120 seconds by 5-second increments.
OSD LOCK OUT	This control completely locks out access to all OSD control functions except for [BRIGHTNESS], [CONTRAST] and [VOLUME]. To activate the [OSD LOCK OUT] function, open the OSD menu, select [OSD LOCK OUT], then touch INPUT/SELECT and > keys simultaneously. To deactivate, touch INPUT/SELECT and < keys simultaneously.

MENU TOOLS Menu

OSD ROTATION

This controls the OSD menu rotation. Depending on the image angle (monitor rotation), select a suitable [OSD ROTATION] setting.

NOTE: Please set the [KEY GUIDE] to [ON] to display the key guide.

Setting (Angle)	Image	Key guide
0		<: LEFT >: RIGHT ∨: DOWN ∧: UP
90		
180		
270		

HOT KEY

When this function is [ON], [BRIGHTNESS], [VOLUME] and [ECO MODE] can be changed without opening the OSD menu.

ON

BRIGHTNESS

Touch the ∧ key, then adjust the [BRIGHTNESS] level in the sub-menu that opens.

VOLUME

Touch the ∨ key, then adjust the [VOLUME] level in the sub-menu that opens.

ECO MODE

Touch the ECO key, the [ECO MODE] sub-menu opens. You can toggle among 3 selections: [OFF], [1] and [2].

OFF

The [HOT KEY] function for the ECO key, ∧ key and ∨ key are disabled.

SIGNAL INFORMATION

If you select [ON], the monitor displays "VIDEO INPUT" after changing the input.

NOTE: The compliance marks that are shown when powering on the monitor the first time are not shown when switching inputs.

The compliance marks are not shown again unless the AC power cord has been disconnected at the power off status and reconnected.

If you select [OFF], the monitor does not display "VIDEO INPUT" after changing the input.

NOTE: Setting [OFF] also prevents the compliance marks from being shown when powering on the monitor.

MENU TOOLS Menu	
SENSOR INFORMATION	If you select [ON], the monitor displays a “HUMAN SENSOR ON” message. If you select [OFF], the monitor doesn’t display the “HUMAN SENSOR ON” message.
KEY GUIDE	If you select [ON], the Key Guide appears on screen when the OSD menu is accessed.
DATA COPY	To initiate data copy from the master monitor to the sub-monitor(s), select [DATA COPY] and touch the INPUT/SELECT key. A “PROCEEDING...” indicator will appear on the screen. NOTE: This function is only intended for the master monitor in ControlSync. All of the settings specified in the ControlSync chart (see page 22) will be copied from the master monitor to the sub monitor(s).
CUSTOMIZE SETTING	Store the current settings for easy recovery. To store current settings: Touch the INPUT/SELECT key. After a warning message appears, touch the ECO/RESET key and the current settings are stored. To restore settings: Touch the MENU key for 3 seconds or more when the OSD menu is closed.

MULTI DISPLAY

MULTI DISPLAY Menu	
MONITOR NO.	This function is for [INDIVIDUAL ADJUST]. Sets the monitor number for each monitor. Control a sub-monitor from the master monitor by [INDIVIDUAL ADJUST]: This function is for controlling a sub-monitor from the master monitor. It is useful if the sub-monitor is located at an unreachable spot. Please set the monitor number for each monitor. If you set a unique number to each of the monitors, you can control a specific monitor. If you set duplicate numbers to some of the monitors, you can control the monitors that have the same number simultaneously. NOTE: A master monitor should be connected only with ControlSync OUT. Do not connect a master monitor with ControlSync IN. See ControlSync for information about master and sub-monitors (page 21).
TARGET MONITOR NO.	Controls a sub-monitor’s OSD by using the master monitor’s control keys. Sets the sub-monitor number that is set at [MONITOR NO.]. By touching the INPUT/SELECT key, each sub-monitor displays its monitor number.
INDIVIDUAL ADJUST	
ON	Controls an individual sub-monitor from the master monitor. Once [ON] is set, operation at the master monitor reflects to the sub-monitor OSD. To disable [INDIVIDUAL ADJUST], please touch the INPUT and MENU keys simultaneously. NOTE: Please connect monitors with the ControlSync cables.

ECO INFORMATION

ECO INFORMATION Menu	
CARBON SAVINGS	Displays the estimated carbon savings information in kg.
CARBON USAGE	Displays the estimated carbon usage information in kg. This is an arithmetic estimation, not actual measurement value.
COST SAVINGS	Displays the electricity cost savings in balance.
CARBON CONVERT SETTING	Adjusts the carbon footprint factor in the carbon saving calculation. This initial setting is based on the OECD data (2008 Edition).
CURRENCY SETTING	Displays electricity pricing in 6 currency units.
CURRENCY CONVERT SETTING	<p>Displays electricity savings in kW/hour (US Currency is default).</p> <p>NOTE: The initial setting is US Dollar [\$] in [CURRENCY SETTING] and \$ [0.11] in [CURRENCY CONVERT SETTING].</p> <p>This setting can be changed by using the [ECO INFORMATION] menu.</p> <p>If you want to use the French setting, please refer to the steps below:</p> <ol style="list-style-type: none"> 1. Touch the MENU key and select the [ECO INFORMATION] menu using the < or > key. 2. Select the [CURRENCY SETTING] item by touching the ^ or v key. 3. The French currency unit is Euro [€]*. You can adjust currency setting to Euro icon [€] from US Dollar [\$] by touching the < or > key in [CURRENCY SETTING] item. 4. Select [CURRENCY CONVERT SETTING] by touching the ^ or v key. 5. Adjust [CURRENCY CONVERT SETTING] by touching the < or > key. <p>* This initial Euro [€] setting is based on the OECD data for Germany (2007 Edition). Please check the receipt of electricity prices for France or OECD data for France. The French value according to the OECD data (2007 Edition) was €0.12.</p>

INFORMATION

INFORMATION Menu	
INFORMATION	Provides information about the current display resolution and technical data including the preset timing being used and the horizontal and vertical frequencies. Indicates the model and serial numbers of your monitor.

OSD Warning

OSD warning messages close by touching the MENU key.

NO SIGNAL: This function gives a warning when there is no horizontal or vertical sync. After power is turned on or when there is a change of input signal, the “**NO SIGNAL**” window will appear.

OUT OF RANGE: This function gives a recommendation of the optimized resolution and refresh rate. After the power is turned on, or there is a change of input signal, or if the video signal doesn’t have proper timing, the “**OUT OF RANGE**” message will appear.

Appendix B Manufacturer's Recycling and Energy Information

This Chapter Includes:

- ⇒ "Disposing of your old NEC product" on page 48
- ⇒ "Energy Saving" on page 48
- ⇒ "WEEE Mark (European Directive 2012/19/EU and amendments)" on page 48

NEC DISPLAY SOLUTIONS is strongly committed to environmental protection and sees recycling as one of the company's top priorities in trying to minimize the burden placed on the environment. We are engaged in developing environmentally-friendly products, and always strive to help define and comply with the latest independent standards from agencies such as ISO (International Organisation for Standardization) and TCO (Swedish Trades Union).

Disposing of your old NEC product

The aim of recycling is to gain an environmental benefit by means of re-use, upgrading, reconditioning or reclamation of material. Dedicated recycling sites ensure that environmentally harmful components are properly handled and securely disposed. To ensure the best recycling of our products, NEC DISPLAY SOLUTIONS offers a variety of recycling procedures and gives advice on how to handle the product in an environmentally sensitive way, once it has reached the end of its life.

All required information concerning the disposal of the product and country-specific information on recycling facilities can be found on our following websites:

<https://www.nec-display-solutions.com/greencompany/> (in Europe),

<https://www.nec-display.com> (in Japan) or

<https://www.necdisplay.com> (in USA).

Energy Saving

This monitor features an advanced energy saving capability. When a Display Power Management signal is sent to the monitor, the Energy Saving mode is activated. The monitor enters a single Energy Saving mode.

For additional information visit:

<https://www.necdisplay.com/> (in USA)

<https://www.nec-display-solutions.com/> (in Europe)

<https://www.nec-display.com/global/index.html> (Global)

For Energy Saving information: [Default setting: USB FUNCTIONALITY → Off]

For ErP requirement:

Setting: [Default setting: USB FUNCTIONALITY → Off]

Power consumption: 0.5 W or less.

Time for power management function: Approx. 1 min.

For ErP (Network standby) requirement:

Setting: [Default setting: USB FUNCTIONALITY → Off]

Power consumption: 0.5 W or less (with 1 port activating) / 3.0 W or less (with all ports activating).

Time for power management function: Approx. 1 min.

WEEE Mark (European Directive 2012/19/EU and amendments)



Disposing of your used product: In the European Union

EU-wide legislation as implemented in each Member State requires that used electrical and electronic products carrying the mark (left) must be disposed of separately from normal household waste. This includes monitors and electrical accessories, such as signal cables or power cords. When you dispose of such products, please follow the guidance of your local authority or ask the shop where you purchased the product, or if applicable, follow applicable legislation or agreement you may have. The mark on electrical and electronic products may only apply to the current European Union Member States.

Outside the European Union

If you wish to dispose of used electrical and electronic products outside the European Union, please contact your local authority and ask for the correct method of disposal.