

E18581



REPUBLIC OF
GAMERS

USER MANUAL

GT-AXE 11000

ROG Rapture Tri-band Gaming Router

ASUS

E18581

First Edition

September 2021

Copyright © 2021 ASUSTeK Computer Inc. All Rights Reserved.

No part of this manual, including the products and software described in it, may be reproduced, transmitted, transcribed, stored in a retrieval system, or translated into any language in any form or by any means, except documentation kept by the purchaser for backup purposes, without the express written permission of ASUSTeK Computer Inc. ("ASUS").

Product warranty or service will not be extended if: (1) the product is repaired, modified or altered, unless such repair, modification or alteration is authorized in writing by ASUS; or (2) the serial number of the product is defaced or missing.

ASUS PROVIDES THIS MANUAL "AS IS" WITHOUT WARRANTY OF ANY KIND, EITHER EXPRESS OR IMPLIED, INCLUDING BUT NOT LIMITED TO THE IMPLIED WARRANTIES OR CONDITIONS OF MERCHANTABILITY OR FITNESS FOR A PARTICULAR PURPOSE. IN NO EVENT SHALL ASUS, ITS DIRECTORS, OFFICERS, EMPLOYEES OR AGENTS BE LIABLE FOR ANY INDIRECT, SPECIAL, INCIDENTAL, OR CONSEQUENTIAL DAMAGES (INCLUDING DAMAGES FOR LOSS OF PROFITS, LOSS OF BUSINESS, LOSS OF USE OR DATA, INTERRUPTION OF BUSINESS AND THE LIKE), EVEN IF ASUS HAS BEEN ADVISED OF THE POSSIBILITY OF SUCH DAMAGES ARISING FROM ANY DEFECT OR ERROR IN THIS MANUAL OR PRODUCT.

SPECIFICATIONS AND INFORMATION CONTAINED IN THIS MANUAL ARE FURNISHED FOR INFORMATIONAL USE ONLY, AND ARE SUBJECT TO CHANGE AT ANY TIME WITHOUT NOTICE, AND SHOULD NOT BE CONSTRUED AS A COMMITMENT BY ASUS. ASUS ASSUMES NO RESPONSIBILITY OR LIABILITY FOR ANY ERRORS OR INACCURACIES THAT MAY APPEAR IN THIS MANUAL, INCLUDING THE PRODUCTS AND SOFTWARE DESCRIBED IN IT.

Products and corporate names appearing in this manual may or may not be registered trademarks or copyrights of their respective companies, and are used only for identification or explanation and to the owners' benefit, without intent to infringe.

Table of contents

1	Getting to know your wireless router	
1.1	Welcome!	7
1.2	Package contents	7
1.3	Your wireless router	8
1.4	Positioning your router	10
1.5	Setup Requirements	11
2	Getting started	
2.1	Router Setup	12
	A. Wired connection	12
	B. Wireless connection	13
2.2	Quick Internet Setup (QIS) with Auto-detection	15
2.3	Connecting to your wireless network	18
3	Configuring the General Settings of ROG Gaming Center	
3.1	Logging into the Web GUI	19
3.2	Dash Board	21
3.3	Aiprotection Pro	24
	3.3.1 Configuring Aiprotection Pro	25
	3.3.2 Blocking Malicious Sites	27
	3.3.3 Two-Way IPS	28
	3.3.4 Infected Device Prevention and Blocking	29
	3.3.5 Setting up Parental Control	30
3.4	Game Acceleration	33
	3.4.1 QoS	34
	3.4.2 Gear Accelerator	35
3.5	Open NAT & Game Profile	36
3.6	Game Radar	38
3.7	Wi-Fi Radar	40
	3.7.1 Wi-Fi Site Survey	41
	3.7.2 Wireless Channel Statistics	42

Table of contents

3.7.3	Advanced Troubleshooting.....	42
3.8	VPN.....	43
3.8.1	VPN Fusion.....	44
3.8.2	Instant Guard.....	46
3.9	Traffic Analyzer.....	47
4	Configuring the Advanced Settings	
4.1	Using the Network Map	48
4.1.1	Setting up the wireless security settings.....	49
4.1.2	Managing your network clients.....	50
4.1.3	Monitoring your USB device	52
4.1.4	ASUS AiMesh	54
4.2	Wireless.....	60
4.2.1	General.....	60
4.2.2	WPS	62
4.2.3	Bridge	64
4.2.4	Wireless MAC Filter	66
4.2.5	RADIUS Setting	67
4.2.6	Professional	68
4.3	Creating a Guest Network.....	72
4.4	LAN.....	74
4.4.1	LAN IP	74
4.4.2	DHCP Server.....	75
4.4.3	Route	77
4.4.4	IPTV	78
4.5	WAN	79
4.5.1	Internet Connection.....	79
4.5.2	Dual WAN	82
4.5.3	Port Trigger.....	83
4.5.4	Virtual Server/Port Forwarding.....	85
4.5.5	DMZ.....	88
4.5.6	DDNS	89

Table of contents

4.5.7	NAT Passthrough.....	90
4.6	Using the USB Application.....	91
4.6.1	Using AiDisk.....	92
4.6.2	Using Servers Center.....	94
4.6.3	3G/4G.....	99
4.7	Using iCloud 2.0.....	100
4.7.1	Cloud Disk.....	101
4.7.2	Smart Access.....	103
4.7.3	iCloud Sync.....	104
4.8	IPv6.....	105
4.9	Firewall.....	106
4.9.1	General.....	106
4.9.2	URL Filter.....	106
4.9.3	Keyword filter.....	107
4.9.4	Network Services Filter.....	108
4.9.5	IPv6 Firewall.....	109
4.10	Administration.....	110
4.10.1	Operation Mode.....	110
4.10.2	System.....	111
4.10.3	Firmware Upgrade.....	112
4.10.4	Restore/Save/Upload Setting.....	112
4.11	System Log.....	113
4.12	Smart Connect.....	114
4.12.1	Setting up Smart Connect.....	114
4.12.2	Smart Connect Rule.....	115
5	Utilities	
5.1	Device Discovery.....	118
5.2	Firmware Restoration.....	119
5.3	Setting up your printer server.....	120
5.3.1	ASUS EZ Printer Sharing.....	120
5.3.2	Using LPR to Share Printer.....	124

5.4	Download Master.....	129
5.4.1	Configuring Bit Torrent download settings.....	130
5.4.2	NZB settings.....	131

6 Troubleshooting

6.1	Basic Troubleshooting.....	132
6.2	Frequently Asked Questions (FAQs)	134

Appendices

Notices	143
Service and Support.....	178





1 Getting to know your wireless router

1.1 Welcome!

Thank you for purchasing ROG Rapture Wireless Router!

The stylish router features 2.4GHz, 5GHz and 6 GHz triple bands for an unmatched concurrent wireless HD streaming; SMB server, UPnP AV server, and FTP server for 24/7 file sharing; a capability to handle 300,000 sessions; and the ASUS Green Network Technology, which provides up to 70% power-saving solution.

1.2 Package contents

- | | |
|---|---|
|  ROG Rapture gaming router |  AC adapter |
|  Network cable (RJ-45) |  Quick Start Guide |

NOTES:

- If any of the items is damaged or missing, contact ASUS for technical inquiries and support, Refer to the ASUS Support Hotline list at the back of this user manual.
 - Keep the original packaging material in case you would need future warranty services such as repair or replacement.
-

1.3 Your wireless router

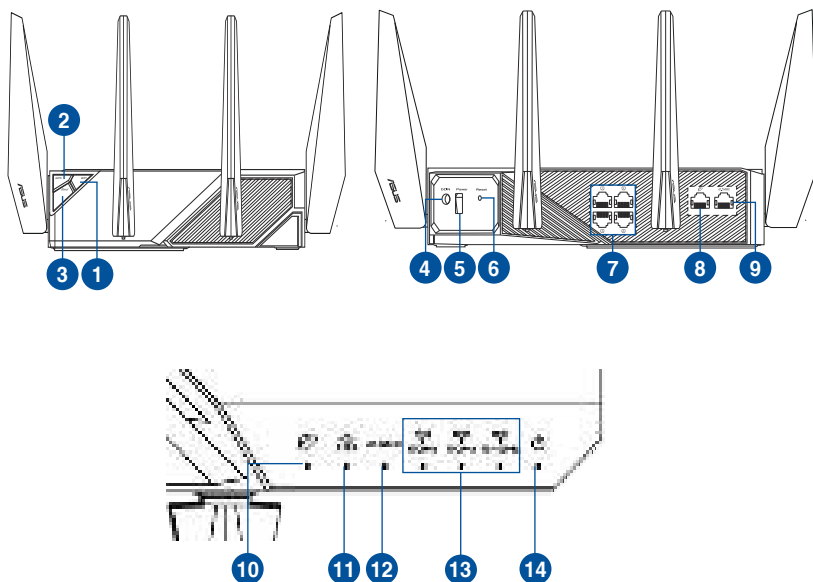

-
- 1 Wi-Fi On/Off button**
Press this button to turn on /off the Wi-Fi connection.

 - 2 WPS button**
This button launches the WPS Wizard.

 - 3 Boost Key**
Press this button to turn on/off LED, DFS channel, Aura RGB and Game Boost.

 - 4 Power (DCIN) port**
Insert the bundled AC adapter into this port and connect your router to a power source.

 - 5 Power button**
Press this button to power on or off the system.

 - 6 Reset button**
This button resets or restores the system to its factory default settings.

 - 7 LAN ports**
Connect network cables into these ports to establish LAN connection.
-

8 WAN (Internet) port
Connect a network cable into this port to establish WAN connection.

9 2.5G WAN / LAN port
Connect network cables into these ports to prioritize the packets.

10 WAN (Internet) LED
Red: No IP or no physical connection.
On: Has physical connection to a wide area network (WAN).

11 LAN LED
Off: No power or no physical connection.
On: Has physical connection to a local area network (LAN).

12 2.5G WAN / LAN LED
Off: No 2.5G WAN / LAN connection.
On: Has physical connection to 2.5G WAN / LAN port.

13 6GHz / 5GHz / 2.4GHz Wi-Fi LED
Off: No 6GHz / 5GHz / 2.4GHz signal.
On: Wireless system is ready.
Flashing: Transmitting or receiving data via wireless connection.

14 Power LED
Off: No power.
On: Device is ready.
Flashing slow: Rescue mode.

NOTES:

- Use only the adapter that came with your package. Using other adapters may damage the device.
- **Specifications:**

DC Power adapter	DC Output: +19V with max 3.42A current +19.5V with max 3.33A current		
Operating Temperature	0~40°C	Storage	0~70°C
Operating Humidity	50~90%	Storage	20~90%

1.4 Positioning your router

For the best wireless signal transmission between the wireless router and the network devices connected to it, ensure that you:

- Place the wireless router in a centralized area for a maximum wireless coverage for the network devices.
- Keep the device away from metal obstructions and away from direct sunlight.
- Keep the device away from 802.11g or 20MHz only Wi-Fi devices, 2.4GHz computer peripherals, Bluetooth devices, cordless phones, transformers, heavy-duty motors, fluorescent lights, microwave ovens, refrigerators, and other industrial equipment to prevent signal interference or loss.
- Always update to the latest firmware. Visit the ASUS website at <http://www.asus.com> to get the latest firmware updates.
- To ensure the best wireless signal, orient the four detachable antennas as shown in the drawing below.

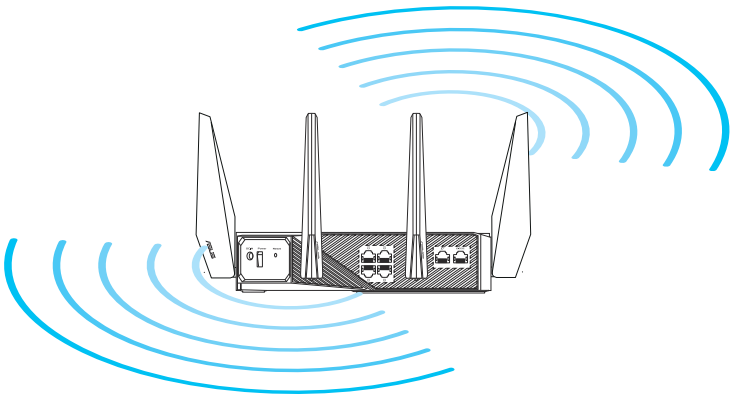

1.5 Setup Requirements

To set up your wireless network, you need a computer that meets the following system requirements:

- Ethernet RJ-45 (LAN) port (10Base-T/100Base-TX/1000BaseTX)
- IEEE 802.11a/b/g/n/ac/ax wireless capability
- An installed TCP/IP service
- Web browser such as Internet Explorer, Firefox, Safari, or Google Chrome

NOTES:

- If your computer does not have built-in wireless capabilities, you may install an IEEE 802.11a/b/g/n/ac/ax WLAN adapter to your computer to connect to the network.
- With its triple band technology, your wireless router supports 2.4GHz, 5GHz and 6GHz wireless signals simultaneously. This allows you to do Internet-related activities such as Internet surfing or reading/writing e-mail messages using the 2.4GHz band while simultaneously streaming high-definition audio/video files such as movies or music using the 5GHz band.
- Some IEEE 802.11n devices that you want to connect to your network may or may not support 5GHz band. Refer to the device's manual for specifications.
- The Ethernet RJ-45 cables that will be used to connect the network devices should not exceed 100 meters.

IMPORTANT!

- Some wireless adapters might have connectivity issues to 802.11ax WiFi APs.
- If you're experiencing such issue, please ensure you update the driver to the latest version. Check your manufacturer's official support site where software drivers, updates, and other related information can be obtained.
 - Realtek: <https://www.realtek.com/en/downloads>
 - Mediatek: <https://www.mediatek.com/products/connectivity-and-networking/broadband-wifi>
 - Intel: <https://downloadcenter.intel.com/>

2 Getting started

2.1 Router Setup

IMPORTANT!

- Use a wired connection when setting up your wireless router to avoid possible setup problems.
 - Before setting up your ASUS wireless router, do the following:
 - If you are replacing an existing router, disconnect it from your network.
 - Disconnect the cables/wires from your existing modem setup. If your modem has a backup battery, remove it as well.
 - Reboot your cable modem and computer (recommended).
-

A. Wired connection

NOTE: You can use either a straight-through cable or a crossover cable for wired connection.

To set up your wireless router via wired connection:

1. Plug your router into a power outlet and power it on. Connect the network cable from your computer to a LAN port on your router.

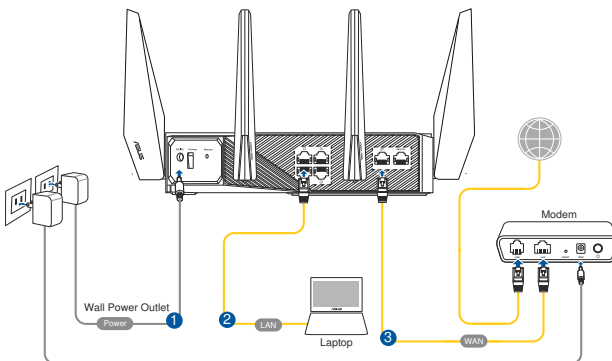

2. The web GUI launches automatically when you open a web browser. If it does not auto-launch, enter <http://router.asus.com>
3. Set up a password for your router to prevent unauthorized access.

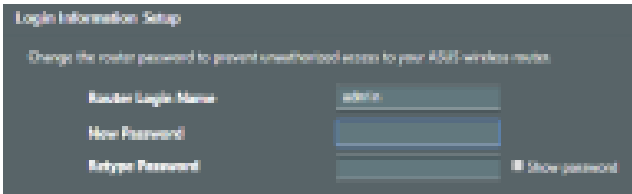

B. Wireless connection

To set up your wireless router via wireless connection:

1. Plug your router into a power outlet and power it on.

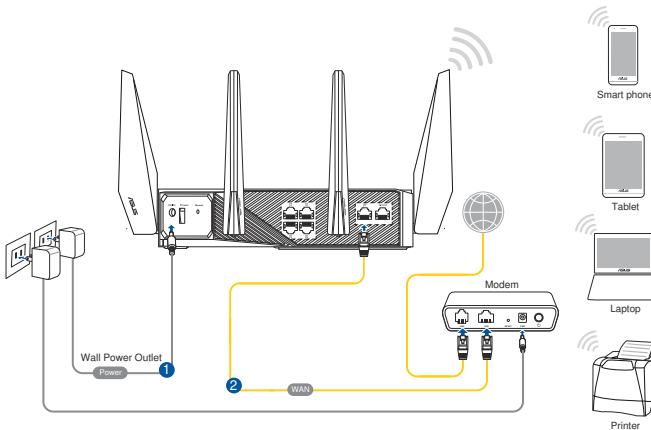

2. Connect to the network name (SSID) shown on the product label on the back side of the router. For better network security, change to a unique SSID and assign a password.



2.4G Wi-Fi Name (SSID):	ASUS_XX_2G
5G Wi-Fi Name (SSID):	ASUS_XX_5G
6G Wi-Fi Name (SSID):	ASUS_XX_6G

* **XX** refers to the last two digits of 2.4GHz MAC address. You can find it on the label on the back of your ROG router.

3. Once connected, the web GUI launches automatically when you open a web browser. If it does not auto-launch, enter <http://router.asus.com>.
4. Set up a password for your router to prevent unauthorized access.

NOTES:

- For details on connecting to a wireless network, refer to the WLAN adapter's user manual.
- To set up the security settings for your network, refer to the section **Setting up the wireless security settings** in Chapter 3 of this user manual.

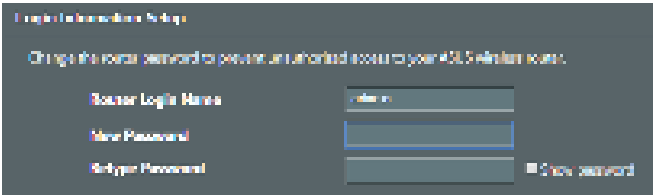

2.2 Quick Internet Setup (QIS) with Auto-detection

The Quick Internet Setup (QIS) function guides you in quickly setting up your Internet connection.

NOTE: When setting the Internet connection for the first time, press the Reset button on your wireless router to reset it to its factory default settings.

To use QIS with auto-detection:

1. Launch a web browser. You will be redirected to the ASUS Setup Wizard (Quick Internet Setup). If not, key in <http://router.asus.com> manually.



2. The wireless router automatically detects if your ISP connection type is **Dynamic IP**, **PPPoE**, **PPTP** and **L2TP**. Key in the necessary information for your ISP connection type.

IMPORTANT! Obtain the necessary information from your ISP about the Internet connection type.

NOTES:

- The auto-detection of your ISP connection type takes place when you configure the wireless router for the first time or when your wireless router is reset to its default settings.
 - If QIS failed to detect your Internet connection type, click **Skip to manual setting** and manually configure your connection settings.
-



3. Assign the wireless network name (SSID) and security key for your 2.4GHz, 5 GHz and 6GHz wireless connection. Click **Apply** when done.



4. On the **Login Information Setup** page, change the router's login password to prevent unauthorized access to your wireless router.





NOTE: The wireless router's login username and password is different from the 2.4GHz/5GHz/6GHz network name (SSID) and security key. The wireless router's login username and password allows you to log into your wireless router's Web GUI to configure your wireless router's settings. The 2.4GHz/5GHz/6GHz network name (SSID) and security key allows Wi-Fi devices to log in and connect to your 2.4GHz/5GHz/6GHz network.

2.3 Connecting to your wireless network

After setting up your wireless router via QIS, you can connect your computer or other smart devices to your wireless network.

To connect to your network:

1. On your computer, click the network icon  in the notification area to display the available wireless networks.
2. Select the wireless network that you want to connect to, then click **Connect**.
3. You may need to key in the network security key for a secured wireless network, then click **OK**.
4. Wait while your computer establishes connection to the wireless network successfully. The connection status is displayed and the network icon displays the connected  status.

NOTES:

- Refer to the next chapters for more details on configuring your wireless network's settings.
 - Refer to your device's user manual for more details on connecting it to your wireless network.
-

3 Configuring the General Settings of ROG Gaming Center

3.1 Logging into the Web GUI

Your ROG Rapture gaming router comes with an intuitive web graphical user interface (GUI) - ROG Gaming Center, which gives you total network control, with need-to-know information such as connected device status and worldwide game-server ping values, and instant access to all the amazing gaming features.

NOTE: The features may vary with different firmware versions.

To log into the web GUI:

1. On your web browser, manually key in the wireless router's default IP address: <http://router.asus.com>.
2. On the login page, key in the default user name (**admin**) and the password that you have set in **2.2 Quick Internet Setup (QIS) with Auto-dection**.

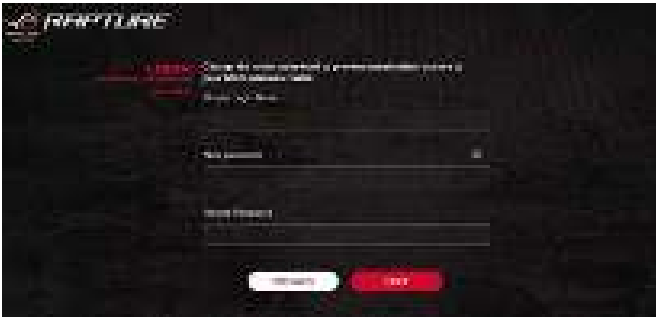

3. You can now use the Web GUI to configure various settings of your ASUS Wireless Router.



NOTE: If you are logging into the Web GUI for the first time, you will be directed to the Quick Internet Setup (QIS) page automatically.

3.2 Dash Board

Dash Board allows you to monitor the real-time traffic for your networking environment and analyze the real-time network ping and ping deviation.



Network ping refers to online game experiences. Higher ping means higher latency for real-time games. For most online games, network ping that is less than 99 ms is considered good quality.

If network ping is less than 150 ms, the quality is acceptable. Generally, if network ping is more than 150 ms, it is hard to play game smoothly.

Ping deviation is also highly related with online game experiences. With higher ping deviation, it is much easier causing possible toggle when playing online game. There is no baseline for ping deviation. However, lower ping deviation is better.



- **Game Radar:** Game Radar from Dashboard could give you a quick look about ping time for specific game server.



- **Aura RGB:** Allows users to define or turn on/off the Aura RGB from Dashboard. You can setup any color and choose either of the five lighting patterns.

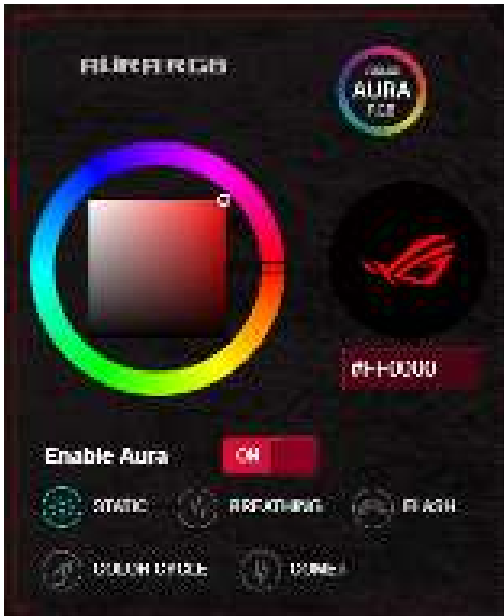

- **Boost Key:** ROG Rapture gaming router supports Boost Key and allows users to define the functions of Boost Key from Dashboard.
 - LED on/off
 - DFS channel on/off
 - Aura RGB on/off
 - Game Boost: enable/disable prioritizing the gaming packet.



3.3 Aiprotection Pro

Aiprotection Pro provides real-time monitoring that detects malware, spyware, and unwanted access. It also filters unwanted websites and apps and allows you to schedule Internet access time for a connected device.



3.3.1 Configuring Aiprotection Pro

Aiprotection Pro prevents network exploits and secures your network from unwanted access.



To Configure Aiprotection Pro:

1. From the navigation panel, go to **General > Aiprotection Pro**.
2. From the Aiprotection Pro main page, click **Network Protection**.
3. From the Network Protection tab, click **Scan**.

The search results are displayed on the **Router Security Assessment** page.



IMPORTANT! Items marked with **Yes** on the **Router Security Assessment** page are considered to be safe.

4. (Optional) From the **Router Security Assessment** page, manually configure the items marked as **No**, **Weak**, or **Very Weak**. To do this:
 - a. Click an item to go to the item's setting page.
 - b. From the item's security settings page, configure and make the necessary changes and click **Apply** when done.
 - c. Go back to the **Router Security Assessment** page and click **Close** to exit the page.
5. Click **OK** on the confirmation message.

3.3.2 Blocking Malicious Sites

This feature restricts access to known malicious websites in the cloud database for an always-up-to-date protection.

NOTE: This function is automatically enabled if you run the Router Weakness Scan.

To enable Malicious Sites Blocking:

1. From the navigation panel, go to **General > Aiprotection Pro**.
2. From the Aiprotection Pro main page, click **Network Protection**.
3. From the Malicious Sites Blocking pane, click **ON**.

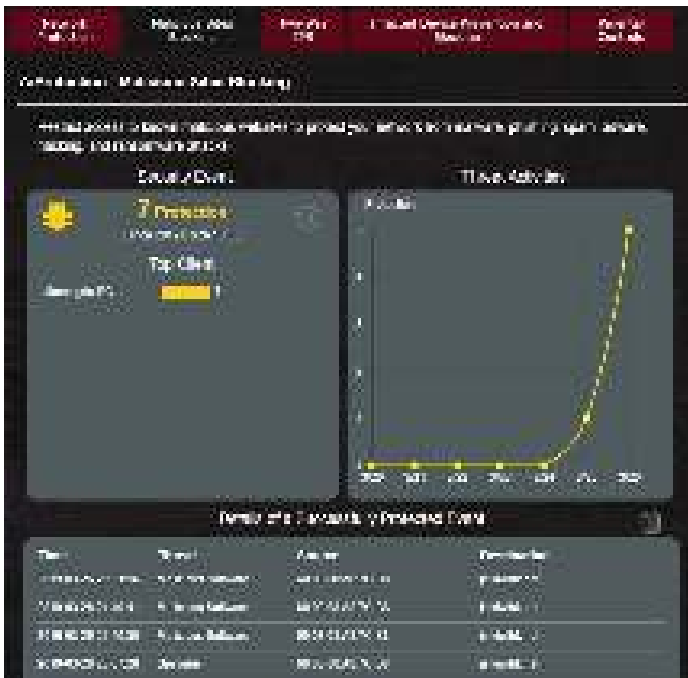

3.3.3 Two-Way IPS

This feature resolves common exploits within the router configuration.

NOTE: This function is automatically enabled if you run the Router Weakness Scan.

To enable Two-Way IPS:

1. From the navigation panel, go to **General > Aiprotection Pro**.
2. From the Aiprotection Pro main page, click **Network Protection**.
3. From the Two-Way IPS pane, click **ON**.

Two-Way IPS

Turn On/Off: **ON**

Top 10

Time	Level	Type	Source	Destination	Priority
2023/08/10 11:00:00	High	DDoS Attack	192.168.1.1	192.168.1.1	High
2023/08/10 11:00:00	High	Malware	192.168.1.1	192.168.1.1	High
2023/08/10 11:00:00	High	Port Scan	192.168.1.1	192.168.1.1	High
2023/08/10 11:00:00	High	Brute Force	192.168.1.1	192.168.1.1	High

3.3.4 Infected Device Prevention and Blocking

This feature prevents infected devices from communicating personal information or infected status to external parties.

NOTE: This function is automatically enabled if you run the Router Weakness Scan.

To enable infected device prevention and blocking:

1. From the navigation panel, go to **General > Aiprotection Pro**.
2. From the Aiprotection Pro main page, click Network Protection.
3. From the Infected Device Prevention and Blocking pane, click **ON**.

To configure Alert Preference:

1. From the Infected Device Prevention and Blocking pane, click **Alert Preference**.
2. Select or key in the e-mail provider, e-mail account, and password then click **Apply**.



3.3.5 Setting up Parental Control

Parental Control allows you to control the Internet access time or set the time limit for a client's network usage.

To enable Two-Way IPS:

1. From the navigation panel, go to **General > Aiprotection Pro**.
2. From the Aiprotection Pro main page, click **Parental Controls** tab.



Web & Apps Filters

Web & Apps Filters is a feature of Parental Controls that allows you to block access to unwanted web sites or applications.

To configure Web & Apps Filters:

1. From the navigation panel, go to **General > Aiprotection Pro**.
2. From the Aiprotection Pro main page, click **Parental Controls** icon to go to the Parental Controls tab.
3. From the **Enable Web & Apps Filters** pane, click **ON**.
4. When the End Users License Agreement (EULA) message prompt appears, click **I agree** to continue.
5. From the **Client List** column, select or key in the client's name from the dropdown list box.
6. From the **Content Category** column, select the filters from the four main categories: **Adult, Instant Message and Communication, P2P and File Transfer**, and **Streaming and Entertainment**.
7. Click  to add the client's profile.
8. Click **Apply** to save the settings.

Time Scheduling

Time Scheduling allows you to set the time limit for a client's network usage.

NOTE: Ensure that your system time is synchronized with the NTP server.



To configure Time Scheduling:

1. From the navigation panel, go to **General > Aiprotection Pro > Parental Controls > Time Scheduling**.
2. From the **Enable Time Scheduling** pane, click **ON**.
3. From the **Clients Name** column, select or key in the client's name from the dropdown list box.

NOTE: You may also key in the client's MAC address in the Client MAC Address column. Ensure that the client name does not contain special characters or spaces as these may cause the router to function abnormally.

4. Click  to add the client's profile.
5. Click **Apply** to save the settings.

3.4 Game Acceleration

This feature allows you to enable Game Boost with one click. When Game Boost is enabled, ROG Rapture gaming router puts the gaming packet as the top priority to provide you with the best gaming experience.



Game Boost

To enable Game Boost:

From the **Game Boost** tab, move the **Enable Game Boost** slider to **ON**.

3.4.1 QoS

This feature ensures bandwidth for prioritized tasks and apps.



To enable the QoS function:

1. From the navigation panel, go to **General > Game Acceleration > QoS** tab.
2. From the **Enable QoS** pane, click **ON**.
3. Select the QoS Type (Adaptive, Traditional or Bandwidth limiter) for your configuration.

NOTE: Refer to the QoS tab for the definition of the QoS Type.

4. Click **Automatic Setting** for optimal bandwidth automatically or **Manual Setting** to set the upload and download bandwidth manually.

NOTE: Get the bandwidth information from your ISP. You can also go to <http://speedtest.net> to check and get your bandwidth.

5. Click **Apply**.

3.4.2 Gear Accelerator

Gear Accelerator allows you to prioritize game devices wirelessly via online control panel for the best gaming experience.



To configure Gear Accelerator:

1. From the navigation panel, go to **General > Game Acceleration**.
2. From the **Gear Accelerator** tab, click **ON**.
3. After applying setting, click **Add** to choose the client name.
4. Click  to add the client's profile.
5. Click **Apply** to save the settings

NOTE: If you want delete the client profile, click .

3.5 Open NAT & Game Profile

Open NAT offers a hassle-free way to create port forwarding rules for online games and optimizes the routing packets from your game console to the modem with an optimized gaming experience.

When playing PC or console games, there may be some connection issues due to the ISP or router settings in your environment such as NAT and port blocks. Game Profile helps ensure that ROG Rapture gaming router is not blocking the game connection.



To configure Open NAT:

1. From the navigation panel, go to **General > Open NAT**.
2. Slide on **Enable Port Forwarding**.
3. From the **Game List**, select a game and complete basic settings.
4. Click **OK**.

3.6 Game Radar

Game Radar is a diagnostic tool that helps you identify the connection quality of servers for specific games.



To use Game Radar:

1. From the navigation panel, go to **General** > **Game Radar** and select a game from the game list.



2. Check the **Ping Status** of each server.
3. For a smooth online gaming experience, select a game server with low ping status.

3.7 Wi-Fi Radar

Wi-Fi Radar, an advanced analysis tool for your wireless network, delves deep into the channels and packet data for troubleshooting.

NOTE: Enabling Wi-Fi Radar may result to a drop wireless performance. Only enable Wi-Fi Radar when needed.



To use Wi-Fi Radar:

1. From the navigation panel, go to **General > Wi-Fi Radar**, go to **Settings** and configure all the Wi-Fi Radar parameters.



2. Click **Start Data Collection**, and set the schedule for data collection.
3. Click **Submit** after you set all the parameters.



3.7.1 Wi-Fi Site Survey

Wi-Fi Site Survey allows you to search for wireless networks in your environment.



3.7.2 Wireless Channel Statistics

This feature shows channel usage of all bands and channel distribution statistics in your environment.



3.7.3 Advanced Troubleshooting

This feature shows Wi-Fi glitch statistics in your environment.



3.8 VPN

A virtual private network (VPN) provides a secure communication with a remote computer or network over a public network such as the Internet.

NOTE: Before setting up a VPN connection, you would need the IP address or domain name of the VPN server.



To set up access to a VPN server:



1. From the navigation panel, go to **General > VPN**.
2. On the **Enable PPTP VPN Server** field, select **ON**.
3. On the **VPN Details** dropdown list, select **Advanced Settings** to configure the advanced VPN settings such as broadcast support, authentication, MPPE Encryption, and Client IP address range.
4. On the **Network Place (Samba) Support** field, select **Yes**.
5. Enter the user name and password for accessing the VPN server. Click .
6. Click **Apply**.

3.8.1 VPN Fusion

VPN Fusion allows you to connect to multiple VPN servers simultaneously and assign your client devices to connect to different VPN tunnels. Some devices like set-top boxes, smart TVs and Blu-ray players do not support VPN software. This feature provides VPN access to such devices in a home network without having to install VPN software, while your smartphone remains connected to Internet not VPN. For Gamer, VPN connection counteracts DDoS attacks to prevent your PC game or your stream from disconnecting with game servers. Building a VPN connection also can simply change your IP address to the region where the game server is located, to improve your ping time to game servers.



To start, please follow the steps below:

1. Click  beside **Server List** to add a new VPN tunnel.
2. Activate the VPN connection you created in Server List.
3. Click  beside **Exception List** and select the online client you want to configure.
4. Assign a VPN connection to the client device, and click **OK**.
5. Activate the VPN policy in **Exception List**, and click **Apply** at the bottom of the page.

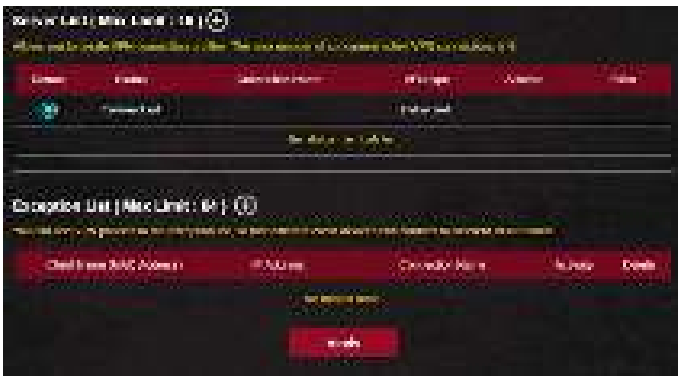

3.8.2 Instant Guard

Instant Guard runs your own private VPN server on your own router. When you use a VPN tunnel, all your data passes through the server. With Instant Guard, you're in total control of your own server, making it the safest possible solution.



3.9 Traffic Analyzer

Traffic Analyzer gives you an at-a-glance view of what's happening on your network on a daily, weekly, or monthly basis. It lets you to quickly see each user's bandwidth usage or the device or app used, helping you reduce the bottlenecks in your Internet connection. It's also a great way to monitor the users' Internet usage or activities.



To configure the Traffic analyzer:

1. From the navigation panel, go to **General > Traffic Analyzer**.
2. From the **Traffic Analyzer** main page, turn on traffic analyzer statistic.
3. Select the date whose chart you want to display.
4. On the **Display for** field, select Router or Apps to display the traffic information.
5. On the Show by field, select how you want to display the traffic information.

4 Configuring the Advanced Settings

4.1 Using the Network Map

Network Map allows you to configure your network's security settings, manage your network clients, and monitor your USB device.



4.1.1 Setting up the wireless security settings

To protect your wireless network from unauthorized access, you need to configure its security settings.

To set up the wireless security settings:

1. From the navigation panel, go to **Advanced Settings > Network Map**.
2. On the Network Map screen and under **System status**, you can configure the wireless security settings such as SSID, security level, and encryption settings.

NOTE: You can set up different wireless security settings for 2.4GHz, 5GHz and 6GHz bands.

2.4GHz security settings



5GHz security settings



6GHz security settings



3. On the **Wireless name (SSID)** field, key in a unique name for your wireless network.
4. From the **Authentication Method** dropdown list, select the authentication method for your wireless network.

If you select WPA-Personal or WPA-2 Personal as the authentication method, key in the WPA-PSK key or security passkey.

IMPORTANT! The IEEE 802.11n/ac standard prohibits using High Throughput with WEP or WPA-TKIP as the unicast cipher. If you use these encryption methods, your data rate will drop to IEEE 802.11g 54Mbps connection.

- 5 Click **Apply** when done.

4.1.2 Managing your network clients





To manage your network clients:

1. From the navigation panel, go to **Advanced Settings > Network Map** tab.
2. On the **Network Map** screen, select the **Clients** icon to display your network client's information.
3. Click View List below the **Clients** icon to display all the clients.
4. To block a client's access to your network, select the client and click the open lock icon.

4.1.3 Monitoring your USB device

The ASUS wireless router provides two USB ports for connecting USB devices or USB printer to allow you to share files and printer with clients in your network.



NOTES:

- To use this feature, you need to plug a USB storage device, such as a USB hard disk or USB flash drive, to the USB 3.0/2.0 ports on the rear panel of your wireless router. Ensure that the USB storage device is formatted and partitioned properly. Refer to the Plug-n-Share Disk Support List at <http://event.asus.com/networks/disksupport>
- The USB ports support two USB drives or one printer and one USB drive at the same time.

IMPORTANT! You first need to create a share account and its permission /access rights to allow other network clients to access the USB device via an FTP site/third-party FTP client utility, Servers Center, Samba, or AiCloud. For more details, refer to the section **4.6 Using the USB Application** and **4.7 Using AiCloud 2.0** in this user manual.

To monitor your USB device:

1. From the navigation panel, go to **Advanced Settings > Network Map**.
2. On the Network Map screen, select the **USB Disk Status** icon to display your USB device's information.
3. On the AiDisk Wizard field, click **GO** to set up an FTP server for Internet file sharing.

NOTES:

- For more details, refer to the section **4.6.2 Using Servers Center** in this user manual.
 - The wireless router works with most USB HDDs/Flash disks (up to 4TB size) and supports read-write access for FAT16, FAT32, NTFS, and HFS+.
-

Safely removing the USB disk

IMPORTANT! Incorrect removal of the USB disk may cause data corruption.

To safely remove the USB disk:

1. From the navigation panel, go to **Advanced Settings > Network Map**.
2. In the upper right corner, click  > **Eject USB disk**. When the USB disk is ejected successfully, the USB status shows **Unmounted**.



4.1.4 ASUS AiMesh

4.1.4.1 Before setting

Preparing to setup an AiMesh Wi-Fi system

1. Two (2) ASUS routers (models supporting AiMesh): <https://www.asus.com/AiMesh/>.
2. Assign one as AiMesh router, and another one as AiMesh node.

NOTE: If you have multiple AiMesh routers, we recommend using the router with the highest specifications as your AiMesh router and the others as AiMesh nodes.

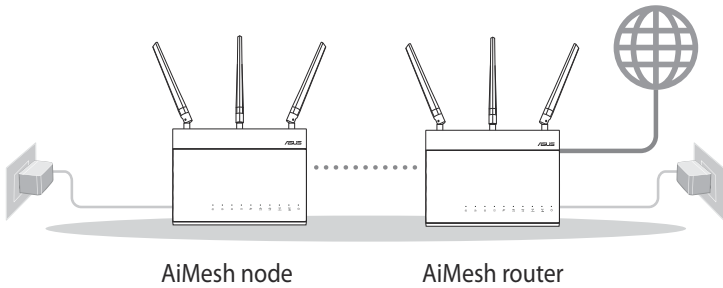

4.1.4.2 AiMesh Setup steps

Prepare

Place your AiMesh router and node within 1-3 meters of each other during the setup process.

AiMesh node

Factory default status. Keep power on and standby for AiMesh system settings.

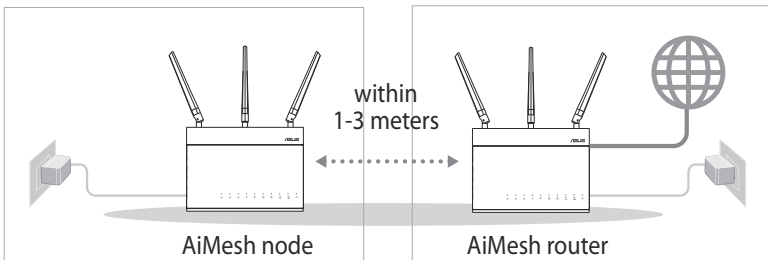

AiMesh router

- 1) Refer to the other router **Quick Start Guide** to connect your AiMesh router to your PC and modem, and then log in into the web GUI.

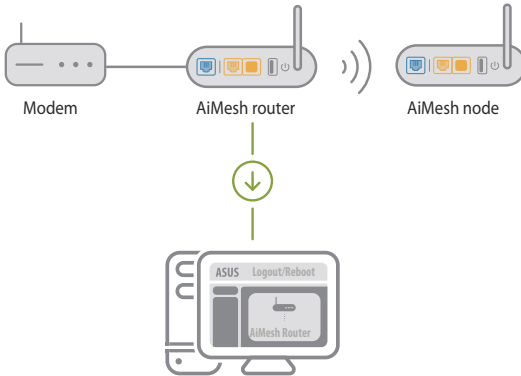

- 2) Go to Network Map page, click AiMesh icon and then Search for your extending AiMesh node.

NOTE: If you cannot find the AiMesh icon here, click on firmware version and update the firmware.

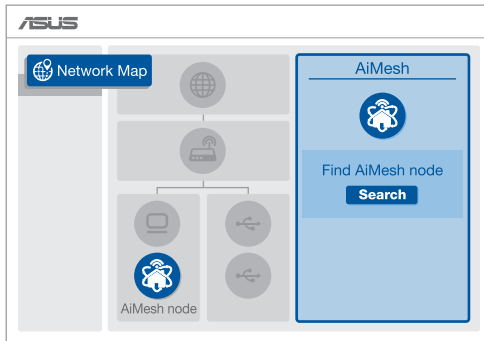

- 3) Click **Search**, it will automatically search for your AiMesh node. When the AiMesh node shows on this page, click it to add it into the AiMesh system.

NOTE: If you cannot find any AiMesh node, please go to **TROUBLE SHOOTING**.

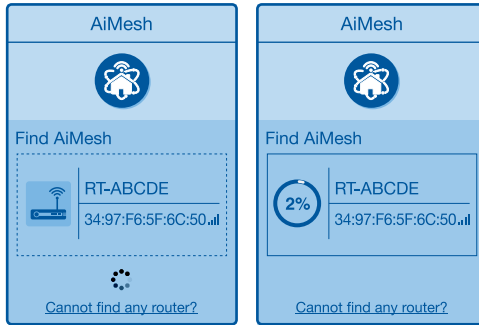

- 4) A message is displayed when synchronization is completed.

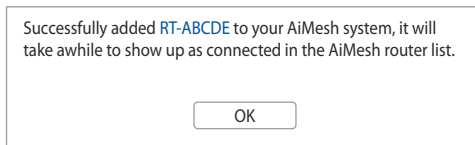

- 5) Congratulations! You will find the pages below show up when an AiMesh node has been successfully added to the AiMesh network.

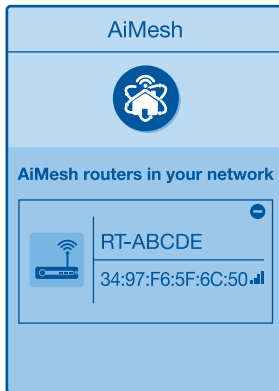

4.1.4.3 Troubleshooting

If your AiMesh router cannot find any AiMesh node nearby or synchronization fails, please check followings and try again.

- 1) Move your AiMesh node closer to the AiMesh router ideally. Ensure it is within 1-3 meters.
- 2) Your AiMesh node is powered on.
- 3) Your AiMesh node is upgraded to AiMesh supported firmware.
 - i. Download AiMesh - supported firmware at:
<https://www.asus.com/AiMesh/>
 - ii. Power on your AiMesh node and connect it to your PC via a network cable.
 - iii. Launch a web GUI. You will be redirected to the ASUS Setup Wizard. If not, navigate to <http://router.asus.com>
 - iv. Go to **Administration > Firmware Upgrade**. Click on **Choose File**, and upload the AiMesh-supported firmware.
 - v. After firmware uploaded, please go to Network Map page to confirm whether AiMesh icon showed up.

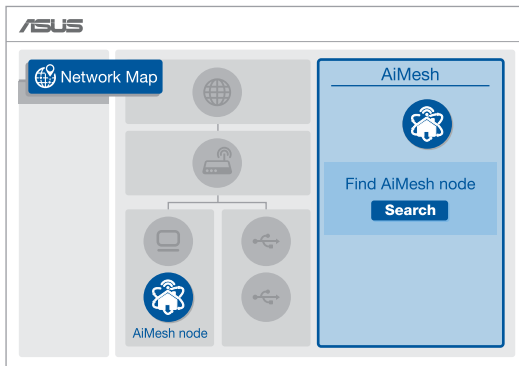

- vi. Press the reset button on your AiMesh node for at least 5 seconds. Release the reset button when the power LED is flashing slowly.

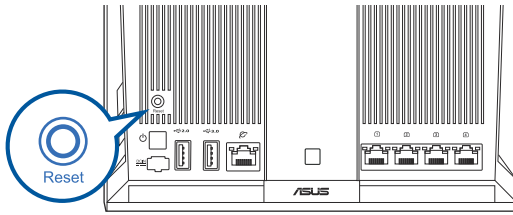

4.1.4.4 Relocation

The best performance:

Locate your AiMesh node and router at the best place.

NOTES:

- To minimize interference, keep the routers away from devices like cordless phones, Bluetooth devices and microwave ovens.
 - We recommend that you place the routers in an open or spacious location.
-



4.1.4.5 FAQ (Frequently Asked Questions)

Q1: Does the AiMesh router support Access Point mode?

A: Yes. You can choose to set the AiMesh router as router mode or access point mode. Please go to web GUI (<http://router.asus.com>), and go to the page **Administration > Operation Mode**.

Q2: Could I setup wired connection between AiMesh routers (Ethernet backhaul)?

A: Yes. AiMesh system supports both wireless and wired connection between AiMesh router and node to maximize throughput and stability. AiMesh analyzes the wireless signal strength for each frequency band available, and then determines automatically whether a wireless or wired connection is best to serve as the inter-router connection backbone.

- 1) Follow the setup steps to establish a connection between the AiMesh router and node via Wi-Fi first.
- 2) Place the node in the ideal locations for best coverage. Run an Ethernet cable from the LAN port of the AiMesh router to the WAN port of AiMesh node.

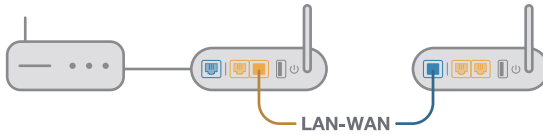

- 3) AiMesh system will auto-select the best path for data transmission, whether wired or wireless.

4.2 Wireless

4.2.1 General

The General tab allows you to configure the basic wireless settings.



To configure the basic wireless settings:

1. From the navigation panel, go to **Advanced Settings > Wireless > General** tab.
2. Select 2.4GHz, 5GHz or 6GHz as the frequency band for your wireless network.
3. If you want to use the Smart Connect function, move the slider to **ON** in the **Enable Smart Connect** field. This function automatically connect the clients in your network to the appropriate band 2.4GHz, 5GHz or 6GHz for optimal speed.

4. Assign a unique name containing up to 32 characters for your SSID (Service Set Identifier) or network name to identify your wireless network. Wi-Fi devices can identify and connect to the wireless network via your assigned SSID. The SSIDs on the information banner are updated once new SSIDs are saved to the settings.

NOTE: You can assign unique SSIDs for the 2.4 GHz, 5GHz and 6GHz frequency bands.

5. In the **Hide SSID** field, select **Yes** to prevent wireless devices from detecting your SSID. When this function is enabled, you would need to enter the SSID manually on the wireless device to access the wireless network.
6. Select any of these wireless mode options to determine the types of wireless devices that can connect to your wireless router:
 - **Auto:** Select **Auto** to allow 802.11ac, 802.11n, 802.11g, and 802.11b devices to connect to the wireless router.
 - **N only:** Select **N only** to maximize wireless N performance. This setting prevents 802.11g and 802.11b devices from connecting to the wireless router.
 - **Legacy:** Select **Legacy** to allow 802.11b/g/n devices to connect to the wireless router. Hardware that supports 802.11n natively, however, will only run at a maximum speed of 54Mbps.
7. Select the operating/control channel for your wireless router. Select **Auto** to allow the wireless router to automatically select the channel that has the least amount of interference.
8. Select the channel bandwidth to accommodate higher transmission speeds.
9. Select the authentication method.
10. When done, click **Apply**.

4.2.2 WPS

WPS (Wi-Fi Protected Setup) is a wireless security standard that allows you to easily connect devices to a wireless network. You can configure the WPS function via the PIN code or WPS button.

NOTE: Ensure that the devices support WPS.



To enable WPS on your wireless network:

1. From the navigation panel, go to **Advanced Settings > Wireless > WPS** tab.
2. In the **Enable WPS** field, move the slider to **ON**.
3. WPS uses 2.4GHz by default. If you want to change the frequency to 5GHz, turn **OFF** the WPS function, click **Switch Frequency** in the **Current Frequency** field, and turn WPS **ON** again.

NOTE: WPS supports authentication using Open System, WPA-Personal, and WPA2-Personal. WPS does not support a wireless network that uses a Shared Key, WPA-Enterprise, WPA2-Enterprise, and RADIUS encryption method.

4. In the WPS Method field, select **Push Button** or **Client PIN** code. If you select **Push Button**, go to step 5. If you select **Client PIN** code, go to step 6.
5. To set up WPS using the router's WPS button, follow these steps:
 - a. Click **Start** or press the WPS button found at the rear of the wireless router.
 - b. Press the WPS button on your wireless device. This is normally identified by the WPS logo.

NOTE: Check your wireless device or its user manual for the location of the WPS button.

- c. The wireless router will scan for any available WPS devices. If the wireless router does not find any WPS devices, it will switch to standby mode.
6. To set up WPS using the Client's PIN code, follow these steps:
 - a. Locate the WPS PIN code on your wireless device's user manual or on the device itself.
 - b. Key in the Client PIN code on the text box.
 - c. Click **Start** to put your wireless router into WPS survey mode. The router's LED indicators quickly flash three times until the WPS setup is completed.

4.2.3 Bridge

Bridge or WDS (Wireless Distribution System) allows your ASUS wireless router to connect to another wireless access point exclusively, preventing other wireless devices or stations to access your ASUS wireless router. It can also be considered as a wireless repeater where your ASUS wireless router communicates with another access point and other wireless devices.



To set up the wireless bridge:

1. From the navigation panel, go to **Advanced Settings > Wireless > WDS** tab.
2. Select the frequency band for the wireless bridge.

3. In the **AP Mode** field, select any of these options:
 - **AP Only:** Disables the Wireless Bridge function.
 - **WDS Only:** Enables the Wireless Bridge feature but prevents other wireless devices/stations from connecting to the router.
 - **HYBRID:** Enables the Wireless Bridge feature and allows other wireless devices/stations to connect to the router.

NOTE: In Hybrid mode, wireless devices connected to the ASUS wireless router will only receive half the connection speed of the Access Point.

4. In the **Connect to APs in list** field, click **Yes** if you want to connect to an Access Point listed in the Remote AP List.
5. By default, the operating/control channel for the wireless bridge is set to **Auto** to allow the router to automatically select the channel with the least amount of interference.

You can modify the **Control Channel** from **Advanced Settings > Wireless > General** tab.

NOTE: Channel availability varies per country or region.

6. On the Remote AP List, key in a MAC address and click the **Add** button  to enter the MAC address of other available Access Points.

NOTE: Any Access Point added to the list should be on the same Control Channel as the ASUS wireless router.

7. Click **Apply**.

4.2.4 Wireless MAC Filter

Wireless MAC filter provides control over packets transmitted to a specified MAC (Media Access Control) address on your wireless network.



To set up the Wireless MAC filter:

1. From the navigation panel, go to **Advanced Settings > Wireless > Wireless MAC Filter** tab.
2. Select the frequency band.
3. Tick **Yes** in the **Enable Mac Filter** field.
4. In the **MAC Filter Mode** dropdown list, select either **Accept** or **Reject**.
 - Select **Accept** to allow devices in the MAC filter list to access to the wireless network.
 - Select **Reject** to prevent devices in the MAC filter list to access to the wireless network.
5. On the MAC filter list, click the **Add**  button and key in the MAC address of the wireless device.
6. Click **Apply**.

4.2.5 RADIUS Setting

RADIUS (Remote Authentication Dial In User Service) Setting provides an extra layer of security when you choose WPA-Enterprise, WPA2-Enterprise, or Radius with 802.1x as your Authentication Mode.



To set up wireless RADIUS settings:

1. Ensure that the wireless router's authentication mode is set to WPA-Enterprise or WPA2-Enterprise.

NOTE: Please refer to section **4.2.1 General** for configuring your wireless router's Authentication Mode.

2. From the navigation panel, go to **Advanced Settings > Wireless > RADIUS Setting**.
3. Select the frequency band.
4. In the **Server IP Address** field, key in your RADIUS server's IP Address.
5. In the **Server Port** field, key in the server port.
6. In the **Connection Secret** field, assign the password to access your RADIUS server.
7. Click **Apply**.

4.2.6 Professional

The Professional screen provides advanced configuration options.

NOTE: We recommend that you use the default values on this page.



In the **Professional Settings** screen, you can configure the following:

- **Frequency:** Select the frequency band that the professional settings will be applied to.
- **Enable Radio:** Select **Yes** to enable wireless networking. Select **No** to disable wireless networking.
- **Enable wireless scheduler:** Select **Yes** to enable and configure wireless scheduler. Select **No** to disable wireless scheduler.
- **Date to Enable Radio (weekdays):** You can specify which days of the week wireless networking is enabled.
- **Time of Day to Enable Radio:** You can specify a time range when wireless networking is enabled during the week.

- **Date to Enable Radio (weekend):** You can specify which days of the weekend wireless networking is enabled.
- **Time of Day to Enable Radio:** You can specify a time range when wireless networking is enabled during the weekend.
- **Set AP isolated:** The Set AP isolated item prevents wireless devices on your network from communicating with each other. This feature is useful if many guests frequently join or leave your network. Select **Yes** to enable this feature or select **No** to disable.
- **Roaming Assistant:** In network configurations that involve multiple Access Points or wireless repeater, wireless clients sometimes cannot connect automatically to the available AP because they are still connected to the main wireless router. Enable this setting so that the client will disconnect from the main wireless router if the signal strength is under a specific threshold and connect to a stronger signal.
- **Enable IGMP Snooping:** Enable this function allows the IGMP (Internet Group Management Protocol) to be monitored among devices and optimizes wireless multicast traffic.
- **Multicast Rate (Mbps):** Select the multicast transmission rate or click **Disable** to switch off simultaneous single transmission.
- **Preamble Type:** Preamble Type defines the length of time that the router spent for CRC (Cyclic Redundancy Check). CRC is a method of detecting errors during data transmission. Select **Short** for a busy wireless network with high network traffic. Select **Long** if your wireless network is composed of older or legacy wireless devices.
- **AMPDU RTS:** Enable this function allows to build a group of frames before they are transmitted and use RTS for every AMPDU for communication among 802.11g and 802.11b devices.
- **RTS Threshold:** Select a lower value for RTS (Request to Send) Threshold to improve wireless communication in a busy or noisy wireless network with high network traffic and numerous wireless devices.

- **DTIM Interval:** DTIM (Delivery Traffic Indication Message) Interval or Data Beacon Rate is the time interval before a signal is sent to a wireless device in sleep mode indicating that a data packet is awaiting delivery. The default value is three milliseconds.
- **Beacon Interval:** Beacon Interval is the time between one DTIM and the next. The default value is 100 milliseconds. Lower the Beacon Interval value for an unstable wireless connection or for roaming devices.
- **Enable TX Bursting:** Enable TX Bursting improves transmission speed between the wireless router and 802.11g devices.
- **Enable WMM APSD:** Enable WMM APSD (Wi-Fi Multimedia Automatic Power Save Delivery) to improve power management between wireless devices. Select **Disable** to switch off WMM APSD.
- **Reducing USB 3.0 interference:** Enable this function ensures the best wireless performance on the 2.4 GHz band. Disabling this feature increase USB 3.0 port's transmission speed and may affect the 2.4 GHz wireless range.
- **Optimize AMPDU aggregation:** Optimize the max number of MPDUs in an AMPDU and avoid packets get lost or corrupted during transmission in error-prone wireless channels
- **Turbo QAM:** Enable this function allows to support 256-QAM (MCS 8/9) on the 2.4GHz band to achieve better range and throughput on that frequency.
- **Airtime Fairness:** With airtime fairness, the speed of the network is not determined by the slowest traffic. By allocating time equally among clients, Airtime Fairness allows every transmission to move at its highest potential speed.
- **Explicit Beamforming:** The client's WLAN adapter and router both support beam forming technology. This technology allows these device to communicate the channel estimation and steering direction to each other to improve download and uplink speed.

- **Universal Beamforming:** For legacy wireless network adapter that do not support beam forming, the router estimates the channel and determines the steering direction to improve the downlink speed.

4.3 Creating a Guest Network

The Guest Network provides temporary visitors with Internet connectivity via access to separate SSIDs or networks without providing access to your private network.

NOTE: GT-AXE11000 supports up to nine SSIDs (three 2.4GHz, three 5GHz and three 6GHz).

To create a guest network:

1. From the navigation panel, go to **Advanced Settings > Guest Network**.
2. On the Guest Network screen, select 2.4Ghz, 5Ghz or 6GHz frequency band for the guest network that you want to create.
3. Click **Enable**.



4. To change a guest's settings, click the guest settings you want to modify. Click **Remove** to delete the guest's settings.
5. Assign a wireless name for your temporary network on the Network Name (SSID) field.
6. Select an Authentication Method.
7. If you select a WPA authentication method, select a WPA Encryption.
8. Specify the Access time or choose **Limitless**.
9. Select **Disable** or **Enable** on the Access Intranet item.
10. When done, click **Apply**.

4.4 LAN

4.4.1 LAN IP

The LAN IP screen allows you to modify the LAN IP settings of your wireless router.

NOTE: Any changes to the LAN IP address will be reflected on your DHCP settings.

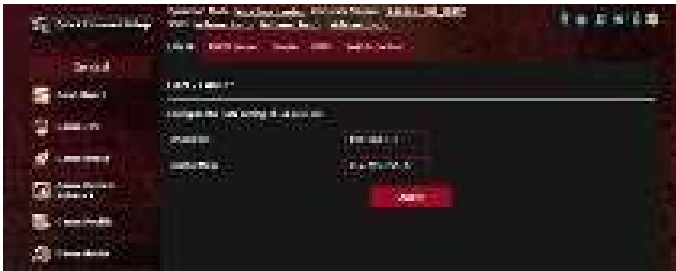

To modify the LAN IP settings:

1. From the navigation panel, go to **Advanced Settings** > **LAN** > **LAN IP** tab.
2. Modify the **IP address** and **Subnet Mask**.
3. When done, click **Apply**.

4.4.2 DHCP Server

Your wireless router uses DHCP to assign IP addresses automatically on your network. You can specify the IP address range and lease time for the clients on your network.



To configure the DHCP server:

1. From the navigation panel, go to **Advanced Settings > LAN > DHCP Server** tab.
2. In the **Enable the DHCP Server** field, tick **Yes**.
3. In the **Domain Name** text box, enter a domain name for the wireless router.
4. In the **IP Pool Starting Address** field, key in the starting IP address.
5. In the **IP Pool Ending Address** field, key in the ending IP address.

6. In the **Lease Time** field, specify in seconds when an assigned IP address will expire. Once it reaches this time limit, the DHCP server will then assign a new IP address.

NOTES:

- We recommend that you use an IP address format of 192.168.1.xxx (where xxx can be any number between 2 and 254) when specifying an IP address range.
 - An IP Pool Starting Address should not be greater than the IP Pool Ending Address.
-
7. In the **DNS and Server Settings** section, key in your DNS Server and WINS Server IP address if needed.
 8. Your wireless router can also manually assign IP addresses to devices on the network. On the **Enable Manual Assignment** field, choose **Yes** to assign an IP address to specific MAC addresses on the network. Up to 32 MAC Addresses can be added to the DHCP list for manual assignment.



4.4.3 Route

If your network makes use of more than one wireless router, you can configure a routing table to share the same Internet service.

NOTE: We recommend that you do not change the default route settings unless you have advanced knowledge of routing tables.



To configure the LAN Routing table:

1. From the navigation panel, go to **Advanced Settings > LAN > Route** tab.
2. On the **Enable static routes** field, choose **Yes**.
3. On the **Static Route List**, enter the network information of other access points or nodes. Click the **Add**  or **Delete**  button to add or remove a device on the list.
4. Click **Apply**.

4.4.4 IPTV

The wireless router supports connection to IPTV services through an ISP or a LAN. The IPTV tab provides the configuration settings needed to set up IPTV, VoIP, multicasting, and UDP for your service. Contact your ISP for specific information regarding your service.



4.5 WAN

4.5.1 Internet Connection

The Internet Connection screen allows you to configure the settings of various WAN connection types.



To configure the WAN connection settings:

1. From the navigation panel, go to **Advanced Settings > WAN > Internet Connection** tab.
2. Configure the following settings below. When done, click **Apply**.
 - **WAN Connection Type:** Choose your Internet Service Provider type. The choices are **Automatic IP**, **PPPoE**, **PPTP**, **L2TP** or **static IP**. Consult your ISP if the router is unable to obtain a valid IP address or if you are unsure the WAN connection type.

- **Enable WAN:** Select **Yes** to allow the router Internet access. Select **No** to disable Internet access.
- **Enable NAT:** NAT (Network Address Translation) is a system where one public IP (WAN IP) is used to provide Internet access to network clients with a private IP address in a LAN. The private IP address of each network client is saved in a NAT table and is used to route incoming data packets.
- **Enable UPnP:** UPnP (Universal Plug and Play) allows several devices (such as routers, televisions, stereo systems, game consoles, and cellular phone), to be controlled via an IP-based network with or without a central control through a gateway. UPnP connects PCs of all form factors, providing a seamless network for remote configuration and data transfer. Using UPnP, a new network device is discovered automatically. Once connected to the network, devices can be remotely configured to support P2P applications, interactive gaming, video conferencing, and web or proxy servers. Unlike Port forwarding, which involves manually configuring port settings, UPnP automatically configures the router to accept incoming connections and direct requests to a specific PC on the local network.
- **Connect to DNS Server automatically:** Allows this router to get the DNS IP address from the ISP automatically. A DNS is a host on the Internet that translates Internet names to numeric IP addresses.
- **Authentication:** This item may be specified by some ISPs. Check with your ISP and fill them in if required.
- **Host Name:** This field allows you to provide a host name for your router. It is usually a special requirement from your ISP. If your ISP assigned a host name to your computer, enter the host name here.

- **MAC Address:** MAC (Media Access Control) address is a unique identifier for your networking device. Some ISPs monitor the MAC address of networking devices that connect to their service and reject any unrecognized device that attempt to connect. To avoid connection issues due to an unregistered MAC address, you can:
 - Contact your ISP and update the MAC address associated with your ISP service.
 - Clone or change the MAC address of the ASUS wireless router to match the MAC address of the previous networking device recognized by the ISP.
- **DHCP query frequency:** Changes the DHCP Discovery interval settings to avoid overloading the DHCP server.

4.5.2 Dual WAN

Your ASUS wireless router provides dual WAN support. You can set the dual WAN feature to any of these two modes:

- **Failover Mode:** Select this mode to use the secondary WAN as the backup network access.
- **Load Balance Mode:** Select this mode to optimize bandwidth, minimize response time and prevent data overload for both primary and secondary WAN connections.



4.5.3 Port Trigger



Port range triggering opens a predetermined incoming port for a limited period of time whenever a client on the local area network makes an outgoing connection to a specified port. Port triggering is used in the following scenarios:

- More than one local client needs port forwarding for the same application at a different time.
- An application requires specific incoming ports that are different from the outgoing ports.



To set up Port Trigger:

1. From the navigation panel, go to **Advanced Settings > WAN > Port Trigger** tab.
2. On the **Enable Port Trigger** field, tick **Yes**.
3. On the **Well-Known Applications** field, select the popular games and web services to add to the Port Trigger List.
4. On the **Trigger Port List** table, key in the following information:
 - **Description:** Enter a short name or description for the service.

- **Trigger Port:** Specify a trigger port to open the incoming port.
 - **Protocol:** Select the protocol, TCP, or UDP.
 - **Incoming Port:** Specify an incoming port to receive inbound data from the Internet.
 - **Protocol:** Select the protocol, TCP, or UDP.
5. Click the **Add**  to enter the port trigger information to the list. Click the **Delete**  button to remove a port trigger entry from the list.
 6. When done, click **Apply**.

NOTES:

- When connecting to an IRC server, a client PC makes an outgoing connection using the trigger port range 66660-7000. The IRC server responds by verifying the username and creating a new connection to the client PC using an incoming port.
 - If Port Trigger is disabled, the router drops the connection because it is unable to determine which PC is requesting for IRC access. When Port Trigger is enabled, the router assigns an incoming port to receive the inbound data. This incoming port closes once a specific time period has elapsed because the router is unsure when the application has been terminated.
 - Port triggering only allows one client in the network to use a particular service and a specific incoming port at the same time.
 - You cannot use the same application to trigger a port in more than one PC at the same time. The router will only forward the port back to the last computer to send the router a request/trigger.
-

4.5.4 Virtual Server/Port Forwarding

Port forwarding is a method to direct network traffic from the Internet to a specific port or a specific range of ports to a device or number of devices on your local network. Setting up Port Forwarding on your router allows PCs outside the network to access specific services provided by a PC in your network.



To set up Port Forwarding:

1. From the navigation panel, go to **Advanced Settings > WAN > Virtual Server / Port Forwarding** tab.
2. On the **Enable Port Forwarding** field, tick **Yes**.
3. On the **Famous Server List** field, select the type of service you want to access.
4. On the **Famous Game List** field, select the popular game that you want to access. This item lists the port required for your selected popular online game to work properly.

5. On the **Port Forwarding List** table, key in the following information:



- **Service Name:** Enter a service name.
- **Port Range:** If you want to specify a Port Range for clients on the same network, enter the Service Name, the Port Range (e.g. 10200:10300), the LAN IP address, and leave the Local Port empty. Port range accepts various formats such as Port Range (300:350), individual ports (566,789) or Mix (1015:1024,3021).

NOTES:

- When your network's firewall is disabled and you set 80 as the HTTP server's port range for your WAN setup, then your http server/web server would be in conflict with the router's web user interface.
- A network makes use of ports in order to exchange data, with each port assigned a port number and a specific task. For example, port 80 is used for HTTP. A specific port can only be used by one application or service at a time. Hence, two PCs attempting to access data through the same port at the same time would fail. For example, you cannot set up Port Forwarding for port 100 for two PCs at the same time.

-
- **Local IP:** Key in the client's LAN IP address.

NOTE: Use a static IP address for the local client to make port forwarding work properly. Refer to section **4.4 LAN** for information.

- **Local Port:** Enter a specific port to receive forwarded packets. Leave this field blank if you want the incoming packets to be redirected to the specified port range.
 - **Protocol:** Select the protocol. If you are unsure, select **BOTH**.
6. Click the **Add**  to enter the port trigger information to the list. Click the **Delete**  button to remove a port trigger entry from the list.
7. When done, click Apply.

To check if Port Forwarding has been configured successfully:

- Ensure that your server or application is set up and running.
- You will need a client outside your LAN but has Internet access (referred to as “Internet client”). This client should not be connected to the ASUS router.
- On the Internet client, use the router’s WAN IP to access the server. If port forwarding has been successful, you should be able to access the files or applications.

Differences between port trigger and port forwarding:

- Port triggering will work even without setting up a specific LAN IP address. Unlike port forwarding, which requires a static LAN IP address, port triggering allows dynamic port forwarding using the router. Predetermined port ranges are configured to accept incoming connections for a limited period of time. Port triggering allows multiple computers to run applications that would normally require manually forwarding the same ports to each PC on the network.
- Port triggering is more secure than port forwarding since the incoming ports are not open all the time. They are opened only when an application is making an outgoing connection through the trigger port.

4.5.5 DMZ

Virtual DMZ exposes one client to the Internet, allowing this client to receive all inbound packets directed to your Local Area Network.

Inbound traffic from the Internet is usually discarded and routed to a specific client only if port forwarding or a port trigger has been configured on the network. In a DMZ configuration, one network client receives all inbound packets.

Setting up DMZ on a network is useful when you need incoming ports open or you want to host a domain, web, or e-mail server.

CAUTION: Opening all the ports on a client to the Internet makes the network vulnerable to outside attacks. Please be aware of the security risks involved in using DMZ.

To set up DMZ:

1. From the navigation panel, go to **Advanced Settings > WAN > DMZ** tab.
2. Configure the setting below. When done, click **Apply**.
 - **IP address of Exposed Station:** Key in the client's LAN IP address that will provide the DMZ service and be exposed on the Internet. Ensure that the server client has a static IP address.

To remove DMZ:

1. Delete the client's LAN IP address from the **IP Address of Exposed Station** text box.
2. When done, click **Apply**.

4.5.6 DDNS

Setting up DDNS (Dynamic DNS) allows you to access the router from outside your network through the provided ASUS DDNS Service or another DDNS service.



To set up DDNS:

1. From the navigation panel, go to **Advanced Settings > WAN > DDNS** tab.
2. Configure the following settings below. When done, click **Apply**.
 - **Enable the DDNS Client:** Enable DDNS to access the ASUS router via the DNS name rather than WAN IP address.
 - **Server and Host Name:** Choose ASUS DDNS or other DDNS. If you want to use ASUS DDNS, fill in the Host Name in the format of xxx.asuscomm.com (xxx is your host name).
 - If you want to use a different DDNS service, click FREE TRIAL and register online first. Fill in the User Name or E-mail Address and Password or DDNS Key fields.
 - **Enable wildcard:** Enable wildcard if your DDNS service requires one.

NOTES:

DDNS service will not work under these conditions:

- When the wireless router is using a private WAN IP address (192.168.x.x, 10.x.x.x, or 172.16.x.x), as indicated by a yellow text.
 - The router may be on a network that uses multiple NAT tables.
-

4.5.7 NAT Passthrough

NAT Passthrough allows a Virtual Private Network (VPN) connection to pass through the router to the network clients. PPTP Passthrough, L2TP Passthrough, IPsec Passthrough and RTSP Passthrough are enabled by default.

To enable / disable the NAT Passthrough settings, go to the **Advanced Settings > WAN > NAT Passthrough** tab. When done, click **Apply**.



4.6 Using the USB Application

The USB Applications function provides AiDisk, Servers Center, Network Printer Server and Download Master submenus.

IMPORTANT! To use the server functions, you need to insert a USB storage device, such as a USB hard disk or USB flash drive, in the USB 3.0 port on the rear panel of your wireless router. Ensure that the USB storage device is formatted and partitioned properly. Refer to the ASUS website at <http://event.asus.com/2009/networks/disksupport/> for the file system support table.



4.6.1 Using AiDisk

AiDisk allows you to share files stored on a connected USB device through the Internet. AiDisk also assists you with setting up ASUS DDNS and an FTP server.

To use AiDisk:

1. From the navigation panel, go to **Advanced Settings > USB Application**, then click the **AiDisk** icon.
2. From the Welcome to AiDisk wizard screen, click **Go**.

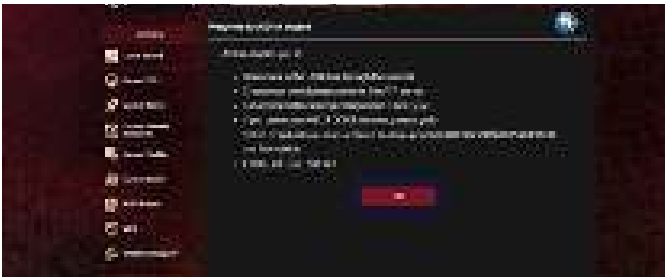

3. Select the access rights that you want to assign to the clients accessing your shared data.



4. Create your domain name via the ASUS DDNS services, read the Terms of Service and then select **I will use the service and accept the Terms of service** and key in your domain name. When done, click **Next**.



You can also select **Skip ASUS DDNS settings** then click **Next** to skip the DDNS setting.

5. Click **Finish** to complete the setting.
6. To access the FTP site that you created, launch a web browser or a third-party FTP client utility and key in the ftp link (**ftp://<domain name>.asuscomm.com**) you have previously created.

4.6.2 Using Servers Center

Servers Center allows you to share the media files from the USB disk via a Media Server directory, Samba share service, or FTP share service. You can also configure other settings for the USB disk in the Servers Center.

Using Media Server

Your wireless router allows DLNA-supported devices to access multimedia files from the USB disk connected to your wireless router.

NOTE: Before using the DLNA Media Server function, connect your device to the router's network.



To launch the Media Server setting page, go to **Advanced Settings > USB Application > Media Servers** tab. Refer to the following for the descriptions of the fields:

- **Enable iTunes Server?:** Select ON/OFF to enable/disable the iTunes Server.
- **Enable UPnP Media Server:** Select ON/OFF to enable/disable the DLNA Media Server.
- **Media Server Status:** Displays the status of the media server.
- **Media Server Path Setting:** Select **All Disks Shared** or **Manual Media Server Path**.

Using Network Place (Samba) Share service

Network Place (Samba) Share allows you to set up the accounts and permissions for the Samba service.



To use Samba share:

1. From the navigation panel, go to **Advanced Settings > USB Application > Network Place (Samba) Share / Cloud Disk** tab.

NOTE: Network Place (Samba) Share is enabled by default.

2. Follow the steps below to add, delete, or modify an account.

To create a new account:

- a) Click  to add new account.
- b) In the **Account** and **Password** fields, key in the name and password of your network client. Retype the password to confirm. Click **Add** to add the account to the list.



To delete an existing account:

- a) Select the account that you want to delete.
- b) Click .
- c) When prompted, click **Delete** to confirm the account deletion.

To add a folder:

- a) Click .
- b) Enter the folder name, and click **Add**. The folder that you created will be added to the folder list.



3. From the list of folders, select the type of access permission that you want to assign for specific folders:
 - **R/W**: Select this option to assign read/write access.
 - **R**: Select this option to assign read-only access.
 - **No**: Select this option if you do not want to share a specific file folder.
4. Click **Apply** to apply the changes.

Using the FTP Share service

FTP share enables an FTP server to share files from USB disk to other devices via your local area network or via the Internet.

IMPORTANT!

- Ensure that you safely remove the USB disk. Incorrect removal of the USB disk may cause data corruption.
 - To safely remove the USB disk, refer to the section **Safely removing the USB disk** under **4.1.3 Monitoring your USB device**.
-

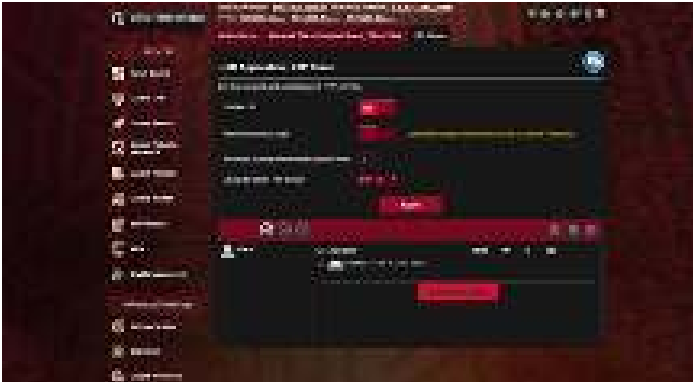

To use FTP Share service:

NOTE: Ensure that you have set up your FTP server through AiDisk. For more details, refer to the section **4.6.1 Using AiDisk**.

1. From the navigation panel, click **Advanced Settings > USB Application > FTP Share** tab.
2. From the list of folders, select the type of access rights that you want to assign for specific folders:
 - **R/W:** Select to assign read/write access for a specific folder.
 - **W:** Select to assign write only access for a specific folder.
 - **R:** Select to assign read only access for a specific folder.
 - **No:** Select this option if you do not want to share a specific folder.
3. If you prefer, you can set the **Allow anonymous login** field to **ON**.
4. In the **Maximum number of concurrent connections** field, key in the number of devices that can simultaneously connect to the FTP share server.
5. Click **Apply** to confirm the changes.
6. To access the FTP server, key in the ftp link **ftp://<hostname>.asuscomm.com** and your user name and password on a web browser or a third-party FTP utility.

4.6.3 3G/4G

3G/4G USB modems can be connected to the router to allow Internet access.

NOTE: For a list of verified USB modems, please visit:
<http://event.asus.com/2009/networks/3gsupport/>

To set up 3G/4G internet access:

1. From the navigation panel, click **Advanced Settings > USB application > 3G/4G**.
2. In the **Enable USB Modem** field, select **Yes**.
3. Set up the following:
 - **Location:** Select your 3G/4G service provider's location from the dropdown list.
 - **ISP:** Select your Internet Service Provider (ISP) from the dropdown list.
 - **APN (Access Point Name) service (optional):** Contact your 3G/4G service provider for detailed information.
 - **Dial Number and PIN code:** The 3G/4G provider's access number and PIN code for connection.

NOTE: PIN code may vary from different providers.

- **Username / Password:** The username and password will be provided by the 3G/4G network carrier.
 - **USB Adapter:** Choose your USB 3G / 4G adapter from the dropdown list. If you are not sure of your USB adapter's model or the model is not listed in the options, select **Auto**.
4. Click **Apply**.

NOTE: The router will reboot for the settings to take effect.

4.7 Using AiCloud 2.0

AiCloud 2.0 is a cloud service application that allows you to save, sync, share, and access your files.



To use AiCloud:

1. From Google Play Store or Apple Store, download and install the ASUS AiCloud app to your smart device.
2. Connect your smart device to your network. Follow the instructions to complete the AiCloud setup process.

4.7.1 Cloud Disk

To create a cloud disk:

1. Insert a USB storage device into the wireless router.
2. Turn on **Cloud Disk**.



3. Go to <https://router.asus.com> and enter the router login account and password. For better user experience, we recommend that you use **Google Chrome** or **Firefox**.



4. You can now start accessing Cloud Disk files on devices connected to the network.

NOTE: When accessing the devices that are connected to the network, you need to enter the device's user name and password manually, which will not be saved by AiCloud for security reason.

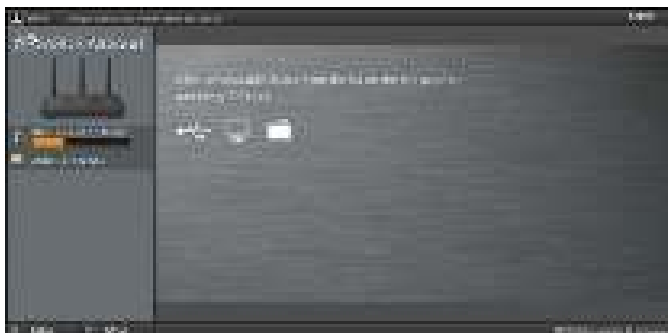

4.7.2 Smart Access

The Smart Access function allows you to easily access your home network via your router's domain name.



NOTES:

- You can create a domain name for your router with ASUS DDNS. For more details, refer to section **4.5.6 DDNS**.
- By default, AiCloud provides a secure HTTPS connection. Key in [https://\[yourASUSDDNSname\].asuscomm.com](https://[yourASUSDDNSname].asuscomm.com) for a very secure Cloud Disk and Smart Access usage.

4.7.3 AiCloud Sync



To use AiCloud Sync:

1. Launch AiCloud, click **AiCloud Sync > Go**.
2. Select **ON** to enable AiCloud Sync.
3. Click **Add new account**.
4. Enter your ASUS WebStorage account password and select the directory that you want to sync with WebStorage.
5. Click **Apply**.

4.8 IPv6

This wireless router supports IPv6 addressing, a system that supports more IP addresses. This standard is not yet widely available. Contact your ISP if your Internet service supports IPv6.

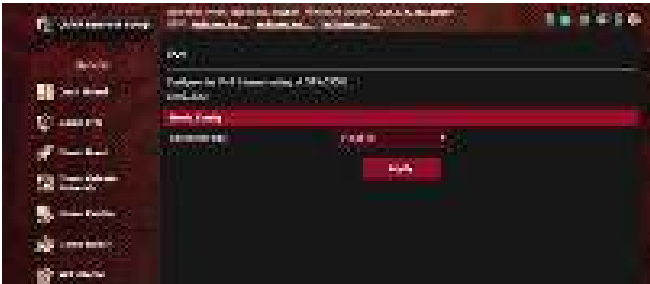

To set up IPv6:

1. From the navigation panel, go to **Advanced Settings > IPv6**.
2. Select your **Connection Type**. The configuration options vary depending on your selected connection type.
3. Enter your IPv6 LAN and DNS settings.
4. Click **Apply**.

NOTE: Please refer to your ISP regarding specific IPv6 information for your Internet service.

4.9 Firewall

The wireless router can serve as a hardware firewall for your network.

NOTE: The Firewall feature is enabled by default.

4.9.1 General

To set up basic Firewall settings:

1. From the navigation panel, go to **Advanced Settings > Firewall > General** tab.
2. On the **Enable Firewall** field, select **Yes**.
3. On the **Enable DoS protection**, select **Yes** to protect your network from DoS (Denial of Service) attacks though this may affect your router's performance.
4. You can also monitor packets exchanged between the LAN and WAN connection. On the Logged packets type, select **Dropped, Accepted, or Both**.
5. Click **Apply**.

4.9.2 URL Filter

You can specify keywords or web addresses to prevent access to specific URLs.

NOTE: The URL Filter is based on a DNS query. If a network client has already accessed a website such as `http://www.abcxxx.com`, then the website will not be blocked (a DNS cache in the system stores previously visited websites). To resolve this issue, clear the DNS cache before setting up the URL Filter.

To set up a URL filter:

1. From the navigation panel, go to **Advanced Settings > Firewall > URL Filter** tab.
2. On the **Enable URL Filter** field, select **Enabled**.
3. Enter a URL and click the  button.
4. Click **Apply**.

4.9.3 Keyword filter

Keyword filter blocks access to webpages containing specified keywords.



To set up a keyword filter:

1. From the navigation panel, go to **Advanced Settings > Firewall > Keyword Filter** tab.
2. On the **Enable Keyword Filter** field, select **Enabled**.

To set up a Network Service filter:

1. From the navigation panel, go to **Advanced Settings > Firewall > Network Service Filter** tab.
2. On the **Enable Network Services Filter** field, select **Yes**.
3. Select the Filter table type. **Black List** blocks the specified network services. **White List** limits access to only the specified network services.
4. Specify the day and time when the filters will be active.
5. To specify a Network Service to filter, enter the Source IP, Destination IP, Port Range, and Protocol. Click the  button.
6. Click **Apply**.

4.9.5 IPv6 Firewall

By default, your ASUS wireless router blocks all unsolicited incoming traffic. The IPv6 Firewall function allows incoming traffic coming from specified services to go through your network.



4.10 Administration

4.10.1 Operation Mode

The Operation Mode page allows you to select the appropriate mode for your network.



To set up the operating mode:

1. From the navigation panel, go to **Advanced Settings > Administration > Operation Mode** tab.
2. Select any of these operation modes:
 - **Wireless router mode / AiMesh Router mode (Default):** In wireless router mode, the wireless router connects to the Internet and provides Internet access to available devices on its own local network.
 - **Access Point(AP) / AiMesh Router in AP mode:** In this mode, the router creates a new wireless network on an existing network.
 - **Repeater mode:** In Repeater mode, GT-AXE11000 wirelessly connects to an existing wireless network to extend the wireless coverage. In this mode, the firewall, IP sharing, and NAT functions are disabled.
 - **Media Bridge:** This setup requires two wireless routers. The second router serves as a media bridge where multiple devices such as Smart TVs and gaming consoles can be connected via ethernet.

- **AiMesh node:** This setup requires at least two ASUS routers which support AiMesh. Enable AiMesh node, and log in AiMesh router web UI to search for available AiMesh nodes nearby to join your AiMesh system. AiMesh system provides whole-home coverage and centralized management.
3. Click **Apply**.

NOTE: The router will reboot when you change the modes.

4.10.2 System

The **System** page allows you to configure your wireless router settings.

To set up the System settings:

1. From the navigation panel, go to **Advanced Settings > Administration > System** tab.
2. You can configure the following settings:
 - **Change router login password:** You can change the password and login name for the wireless router by entering a new name and password.
 - **Time Zone:** Select the time zone for your network.
 - **NTP Server:** The wireless router can access a NTP (Network time Protocol) server in order to synchronize the time.
 - **Enable Telnet:** Click **Yes** to enable Telnet services on the network. Click **No** to disable Telnet.
 - **Authentication Method:** You can select HTTP, HTTPS, or both protocols to secure router access.
 - **Enable Web Access from WAN:** Select **Yes** to allow devices outside the network to access the wireless router GUI settings. Select **No** to prevent access.
 - **Allow only specified IP address:** Click **Yes** if you want to specify the IP addresses of devices that are allowed access to the wireless router GUI settings from WAN.
 - **Client List:** Enter the WAN IP addresses of networking devices allowed to access the wireless router settings. This list will be used if you clicked **Yes** in the **Only allow specific IP** item.
3. Click **Apply**.

4.10.3 Firmware Upgrade

NOTE: Download the latest firmware from the ASUS website at <http://www.asus.com>

To upgrade the firmware:

1. From the navigation panel, go to **Advanced Settings > Administration > Firmware Upgrade** tab.
2. In the **New Firmware File** field, click **Browse** to locate the downloaded file.
3. Click **Upload**.

NOTES:

- When the upgrade process is complete, wait for some time for the system to reboot.
 - If the upgrade process fails, the wireless router automatically enters rescue mode and the power LED indicator on the front panel starts flashing slowly. To recover or restore the system, refer to section **5.2 Firmware Restoration**.
-

4.10.4 Restore/Save/Upload Setting

To restore/save/upload wireless router settings:

1. From the navigation panel, go to **Advanced Settings > Administration > Restore/Save/Upload Setting** tab.
2. Select the tasks that you want to do:
 - To restore to the default factory settings, click **Restore**, and click **OK** in the confirmation message.
 - To save the current system settings, click **Save**, navigate to the folder where you intend to save the file and click **Save**.
 - To restore from a saved system settings file, click **Browse** to locate your file, then click **Upload**.

IMPORTANT! If issues occur, upload the latest firmware version and configure new settings. Do not restore the router to its default settings.

4.11 System Log

System Log contains your recorded network activities.

NOTE: System log resets when the router is rebooted or powered off.

To view your system log:

1. From the navigation panel, go to **Advanced Settings > System Log**.
2. You can view your network activities in any of these tabs:
 - General Log
 - Wireless Log
 - DHCP Leases
 - IPv6
 - Routing Table
 - Port Forwarding
 - Connections

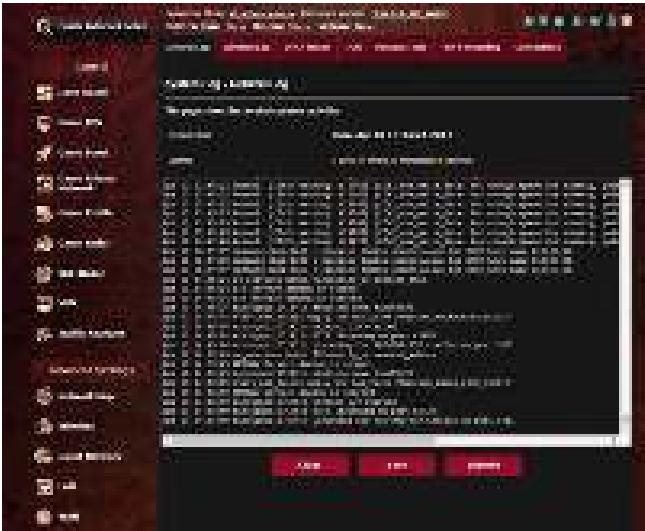

4.12 Smart Connect

Smart Connect is designed to automatically steer clients to one of three radios (2.4 GHz, 5 GHz and 6 GHz) to maximize total wireless throughput use.

4.12.1 Setting up Smart Connect

You can enable Smart Connect from the Web GUI through the following two ways:

- **Via the Wireless screen**
 1. On your web browser, manually key in the wireless router's default IP address: <http://router.asus.com>.
 2. On the login page, key in the default user name (**admin**) and password (**admin**) and click **OK**. The QIS page launches automatically.
 3. From the navigation panel, go to **Advanced Settings > Wireless > General** tab.
 4. Move the slider to **ON** in the **Enable Smart Connect** field. This function automatically connect the clients in your network to the appropriate band for optimal speed.



4.12.2 Smart Connect Rule

ASUSWRT provides default condition settings to trigger switching mechanism. You can also change the trigger conditions according to your networking surroundings. To change the settings, go to the **Smart Connect Rule** tab on the Network Tools screen.

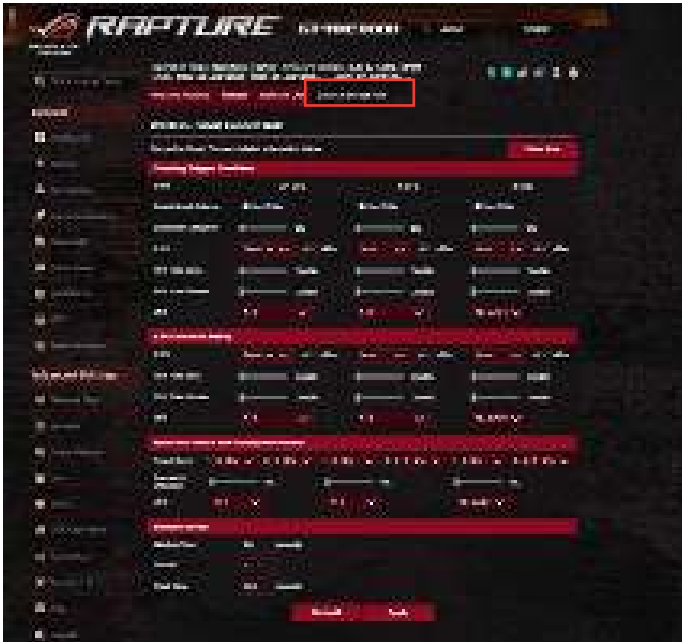

Smart Connect Rule controls are divided into four sections:

- Steering Trigger Condition
- STA Selection Policy
- Interface Select and Qualify Procedures
- Bounce Detect

Steering Trigger Condition

This set of controls sets the criteria to initiate band steering.

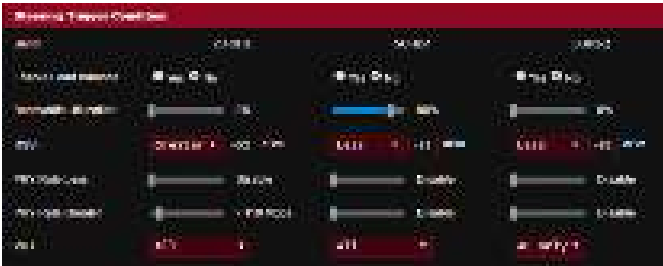

- **Bandwidth Utilization**
When bandwidth use exceeds this percentage, steering will be initiated.
- **Enable Load Balance**
This controls load balancing.
- **RSSI**
If the received signal level of any associated client meets this criteria, steering will be triggered.
- **PHY Rate Less / PHY Rate Greater**
These controls determine STA link rates that trigger band steering.
- **VHT**
This controls determines how 802.11ac and non-ac clients are handled.
 - **ALL** (default) means any type of client can trigger steering.
 - **AC only** means a client must support 802.11ac to trigger steering.
 - **Not-allowed** means only non-802.11ac clients will trigger steering, i.e. 802.11a/b/g/n.

STA Selection Policy

Once steering has been triggered, ASUSWRT will follow the STA Selection Policy to select a client(STA) that is going to be steered to the most appropriate band.

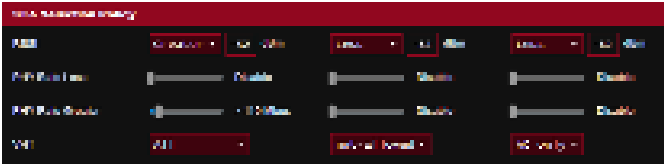

Interface Select and Qualify Procedures

These controls determine where the steered client will end up. The **Target Band** controls specify first and second choice of steering targets. Clients meeting the STA selection policy criteria for the radio will be steered to the first target if that radio's **Bandwidth Utilization** is less than the set value. Otherwise, the client will be sent to the second **Target Band** radio.



Bounce Detect

This set of controls determines how often a client can be steered. This is intended to prevent clients from constantly moving around. It does not, however, prevent clients from disconnecting on their own, or counting them as bounces if they do. Each client can be steered N **Counts** within the **Window Time**. When the Count limit is hit, the client will not be steered again for **Dwell Time**.



5 Utilities

NOTES:

- Download and install the wireless router's utilities from the ASUS website:
 - Device Discovery v1.4.7.1 at <http://dlcdnet.asus.com/pub/ASUS/LiveUpdate/Release/Wireless/Discovery.zip>
 - Firmware Restoration v1.9.0.4 at <http://dlcdnet.asus.com/pub/ASUS/LiveUpdate/Release/Wireless/Rescue.zip>
 - Windows Printer Utility v1.0.5.5 at <http://dlcdnet.asus.com/pub/ASUS/LiveUpdate/Release/Wireless/Printer.zip>
 - The utilities are not supported on MAC OS.
-

5.1 Device Discovery

Device Discovery is an ASUS WLAN utility that detects an ASUS wireless router device, and allows you to configure the wireless networking settings.

To launch the Device Discovery utility:

- From your computer's desktop, click **Start > All Programs > ASUS Utility > ASUS Wireless Router > Device Discovery.**

NOTE: When you set the router to Access Point mode, you need to use Device Discovery to get the router's IP address.

5.2 Firmware Restoration

Firmware Restoration is used on an ASUS Wireless Router that failed during its firmware upgrading process. It uploads the firmware that you specify. The process takes about three to four minutes.

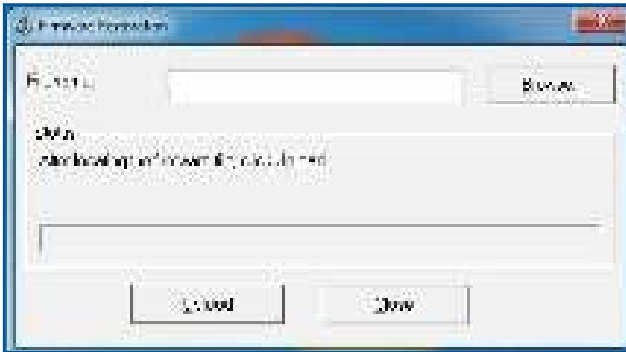

IMPORTANT! Launch the rescue mode on the router before using the Firmware Restoration utility.

NOTE: This feature is not supported on MAC OS.

To launch the rescue mode and use the Firmware Restoration utility:

1. Unplug the wireless router from the power source.
2. Hold the Reset button at the rear panel and simultaneously replug the wireless router into the power source. Release the Reset button when the Power LED at the front panel flashes slowly, which indicates that the wireless router is in the rescue mode.

3. Set a static IP on your computer and use the following to set up your TCP/IP settings:

IP address: 192.168.1.x

Subnet mask: 255.255.255.0

4. From your computer's desktop, click **Start > All Programs > ASUS Utility GT-AXE11000 Wireless Router > Firmware Restoration.**
5. Specify a firmware file, then click **Upload.**

NOTE: This is not a firmware upgrade utility and cannot be used on a working ASUS Wireless Router. Normal firmware upgrades must be done through the web interface. Refer to **Chapter 4: Configuring the Advanced Settings** for more details.

5.3 Setting up your printer server

5.3.1 ASUS EZ Printer Sharing

ASUS EZ Printing Sharing utility allows you to connect a USB printer to your wireless router's USB port and set up the print server. This allows your network clients to print and scan files wirelessly.



NOTE: The print server function is supported on Windows® 7/8/8.1/10.

To set up the EZ Printer sharing mode:

1. From the navigation panel, go to **Advanced Settings > USB Application > Network Printer Server**.
2. Click **Download Now!** to download the network printer utility.



NOTE: Network printer utility is supported on Windows® 7/8/8.1/10. To install the utility on Mac OS, select **Use LPR protocol for sharing printer**.

3. Unzip the downloaded file and click the Printer icon to run the network printer setup program.

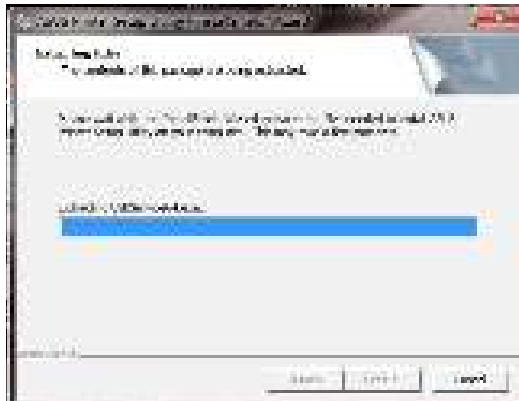

4. Follow the onscreen instructions to set up your hardware, then click **Next**.



5. Wait a few minutes for the initial setup to finish. Click **Next**.
6. Click **Finish** to complete the installation.

7. Follow the Windows® OS instructions to install the printer driver.

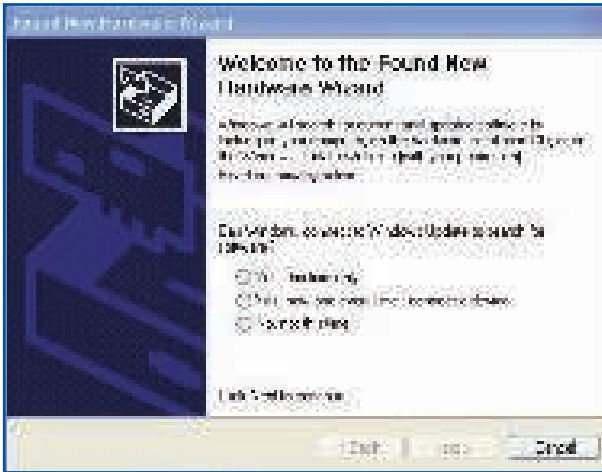

8. After the printer's driver installation is complete, network clients can now use the printer.

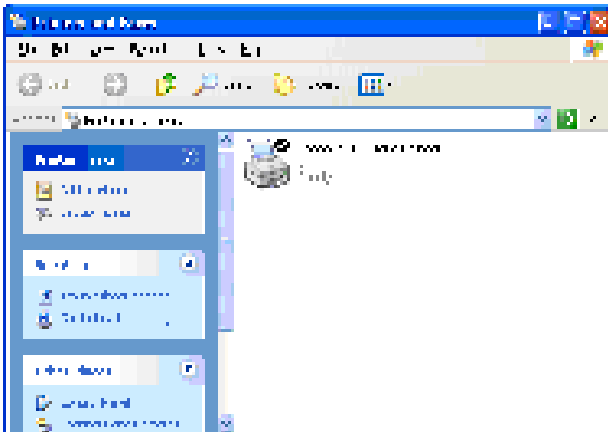

5.3.2 Using LPR to Share Printer

You can share your printer with computers running on Windows® and MAC operating system using LPR/LPD (Line Printer Remote/ Line Printer Daemon).

Sharing your LPR printer

To share your LPR printer:

1. From the Windows® desktop, click **Start > Devices and Printers > Add a printer** to run the **Add Printer Wizard**.

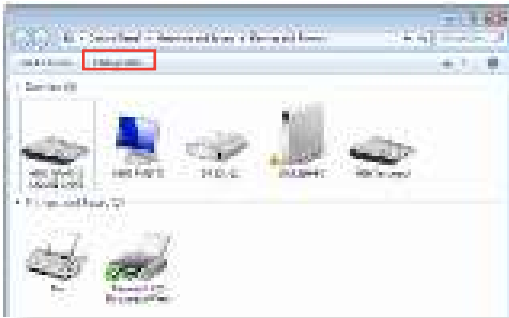

2. Select **Add a local printer** and then click **Next**.

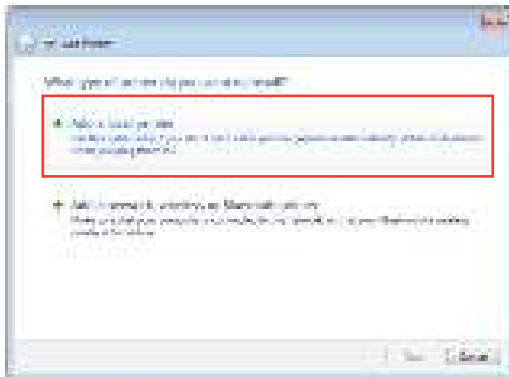

3. Select **Create a new port** then set **Type of Port** to **Standard TCP/IP Port**. Click **Next**.

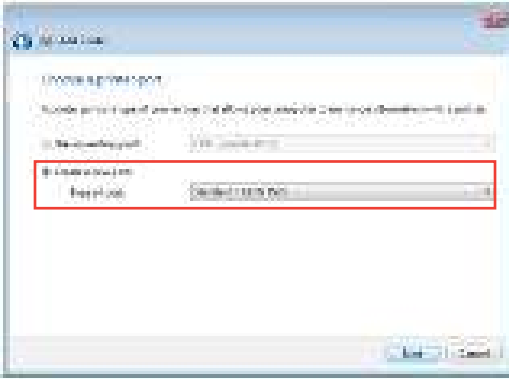

4. In the **Hostname or IP address** field, key in the IP address of the wireless router then click **Next**.

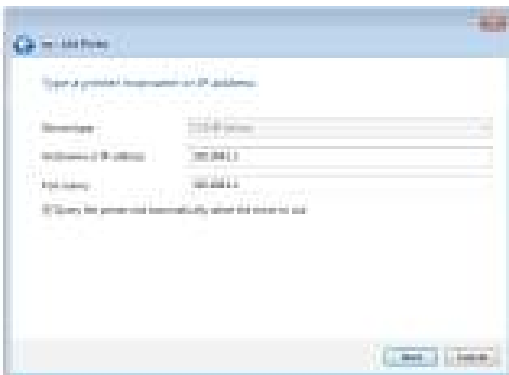

5. Select **Custom** then click **Settings**.

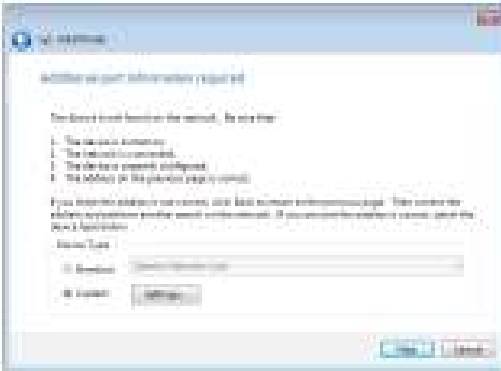

6. Set **Protocol** to **LPR**. In the **Queue Name** field, key in **LPRServer** then click **OK** to continue.

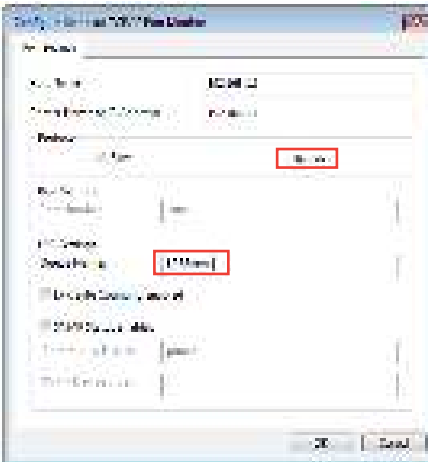

7. Click **Next** to finish setting up the standard TCP/IP port.

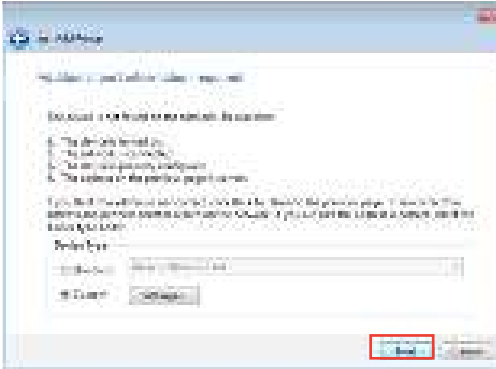

8. Install the printer driver from the vendor-model list. If your printer is not in the list, click **Have Disk** to manually install the printer drivers from a CD-ROM or file.

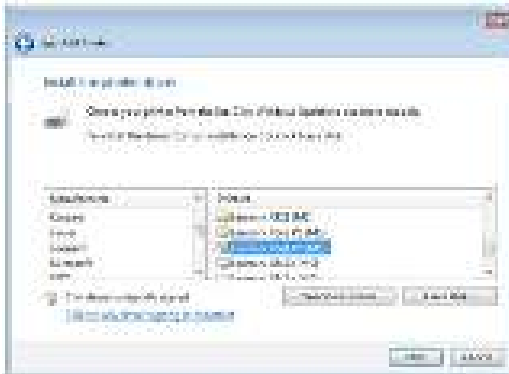

9. Click **Next** to accept the default name for the printer.

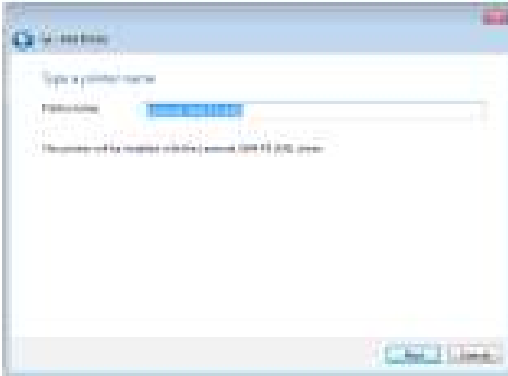

10. Click **Finish** to complete the installation.

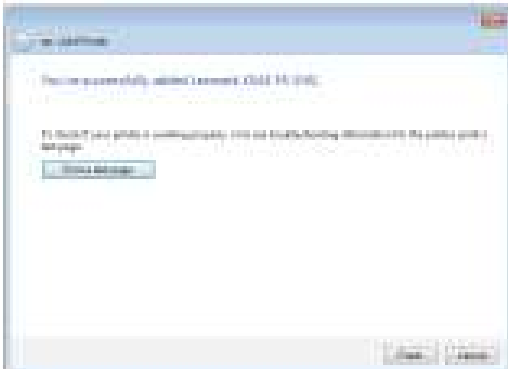

5.4 Download Master

Download Master is a utility that helps you download files even while your laptops or other devices are switched off.

NOTE: You need a USB device connected to the wireless router to use Download Master.

To use Download Master:

1. Click **Advanced Settings > USB Application > Download Master** to download and install the utility automatically.

NOTE: If you have more than one USB drive, select the USB device you want to download the files to.

2. After the download process is finished, click the Download Master icon to start using the utility.
3. Click **Add** to add a download task.

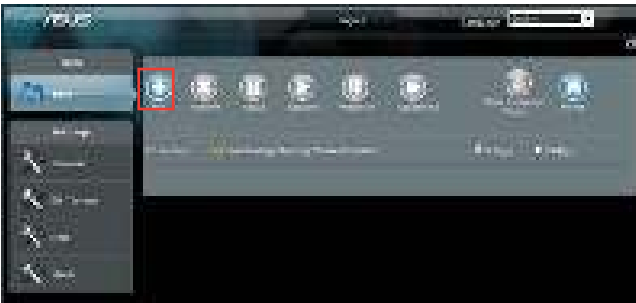

4. Select a download type such as BitTorrent, HTTP, or FTP. Provide a torrent file or a URL to begin downloading.

NOTE: For details on Bit Torrent, refer to section **5.4.1 Configuring the Bit Torrent download settings**.

5. Use the navigation panel to configure the advanced settings.

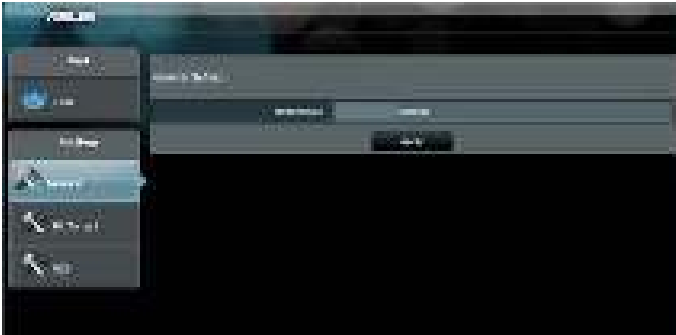

5.4.1 Configuring Bit Torrent download settings

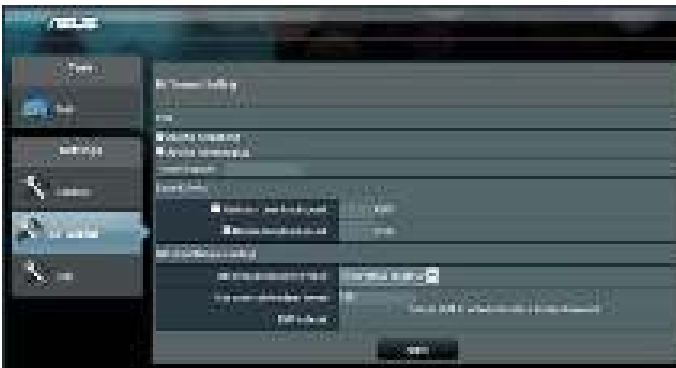

To configure BitTorrent download settings:

1. From Download Master's navigation panel, click **Bit Torrent** to launch the **Bit Torrent Setting** page.
2. Select a specific port for your download task.
3. To prevent network congestion, you can limit the maximum upload and download speeds under **Speed Limits**.
4. You can limit the maximum number of allowed peers and enable or disable file encryption during downloads.

5.4.2 NZB settings

You can set up a USENET server to download NZB files. After entering USENET settings, **Apply**.



6 Troubleshooting

This chapter provides solutions for issues you may encounter with your router. If you encounter problems that are not mentioned in this chapter, visit the ASUS support site at:

<https://www.asus.com/support> for more product information and contact details of ASUS Technical Support.

6.1 Basic Troubleshooting

If you are having problems with your router, try these basic steps in this section before looking for further solutions.

Upgrade Firmware to the latest version.

1. Launch the Web GUI. Go to **Advanced Settings > Administration > Firmware Upgrade** tab. Click **Check** to verify if the latest firmware is available.
2. If the latest firmware is available, visit the ASUS global website at https://rog.asus.com/networking/rog-rapture-gt-axe11000-model/helpdesk_download to download the latest firmware.
3. From the **Firmware Upgrade** page, click **Browse** to locate the firmware file.
4. Click **Upload** to upgrade the firmware.

Restart your network in the following sequence:

1. Turn off the modem.
2. Unplug the modem.
3. Turn off the router and computers.
4. Plug in the modem.
5. Turn on the modem and then wait for 2 minutes.
6. Turn on the router and then wait for 2 minutes.
7. Turn on computers.

Check if your Ethernet cables are plugged properly.

- When the Ethernet cable connecting the router with the modem is plugged in properly, the WAN LED will be on.
- When the Ethernet cable connecting your powered-on computer with the router is plugged in properly, the corresponding LAN LED will be on.

Check if the wireless setting on your computer matches that of your computer.

- When you connect your computer to the router wirelessly, ensure that the SSID (wireless network name), encryption method, and password are correct.

Check if your network settings are correct.

- Each client on the network should have a valid IP address. ASUS recommends that you use the wireless router's DHCP server to assign IP addresses to computers on your network.
- Some cable modem service providers require you to use the MAC address of the computer initially registered on the account. You can view the MAC address in the web GUI, **Network Map > Clients** page, and hover the mouse pointer over your device in **Client Status**.



6.2 Frequently Asked Questions (FAQs)

I cannot access the router GUI using a web browser

- If your computer is wired, check the Ethernet cable connection and LED status as described in the previous section.
- Ensure that you are using the correct login information. The default factory login name and password is “admin/admin”. Ensure that the Caps Lock key is disabled when you enter the login information.
- Delete the cookies and files in your web browser. For Internet Explorer, follow these steps:
 1. Launch Internet Explorer, then click **Tools > Internet Options**.
 2. In the **General** tab, under **Browsing history**, click **Delete...**, select **Temporary Internet files and website files** and **Cookies and website data** then click **Delete**.

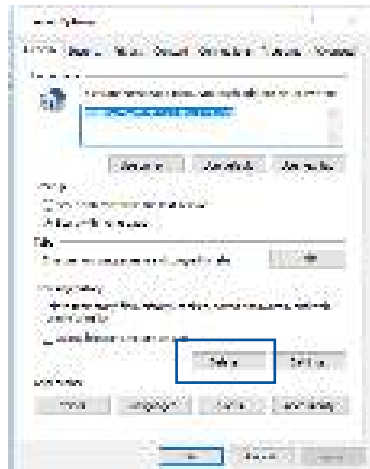

NOTES:

- The commands for deleting cookies and files vary with web browsers.
- Disable proxy server settings, cancel the dial-up connection, and set the TCP/IP settings to obtain IP addresses automatically. For more details, refer to Chapter 1 of this user manual.
- Ensure that you use CAT5e or CAT6 ethernet cables.

The client cannot establish a wireless connection with the router.

NOTE: If you are having issues connecting to 5GHz network, make sure that your wireless device supports 5GHz or features dual band capabilities.

- **Out of Range:**
 - Move the router closer to the wireless client.
 - Try to adjust antennas of the router to the best direction as described in section **1.4 Positioning your router.**
- **DHCP server has been disabled:**
 1. Launch the web GUI. Go to **Advanced Settings > Network Map > Clients** and search for the device that you want to connect to the router.
 2. If you cannot find the device in the **Network Map**, go to **Advanced Settings > LAN > DHCP Server, Basic Config** list, select **Yes** on the **Enable the DHCP Server.**



- SSID has been hidden. If your device can find SSIDs from other routers but cannot find your router's SSID, go to **Advanced Settings > Wireless > General**, select **No** on **Hide SSID**, and select **Auto** on **Control Channel**.



- If you are using a wireless LAN adapter, check if the wireless channel in use conforms to the channels available in your country/area. If not, adjust the channel, channel bandwidth, and wireless mode.
- If you still cannot connect to the router wirelessly, you can reset your router to factory default settings. In the router GUI, click **Administration > Restore/Save/Upload Setting** and click **Restore**.



Internet is not accessible.

- Check if your router can connect to your ISP's WAN IP address. To do this, launch the web GUI and go to **Advanced Settings > Network Map**, and check the **Internet Status**.
- If your router cannot connect to your ISP's WAN IP address, try restarting your network as described in the section **Restart your network in following sequence** under **Basic Troubleshooting**.



- The device has been blocked via the Parental Control function. Go to **General > AiProtection > Parental Controls** tab and see if the device is in the list. If the device is listed under **Client Name**, remove the device using the **Delete** button or adjust the Time Management Settings.
- If there is still no Internet access, try to reboot your computer and verify the network's IP address and gateway address.
- Check the status indicators on the ADSL modem and the wireless router. If the WAN LED on the wireless router is not ON, check if all cables are plugged properly.

You forgot the SSID (network name) or network password

- Setup a new SSID and encryption key via a wired connection (Ethernet cable). Launch the web GUI, go to **Network Map**, click the router icon, enter a new SSID and encryption key, and then click **Apply**.
- Reset your router to the default settings. Launch the web GUI, go to **Administration > Restore/Save/Upload Setting**, and click **Restore**. The default login account and password are both "admin".

How to restore the system to its default settings?

- Go to **Administration > Restore/Save/Upload Setting**, and click **Restore**.

The following are the factory default settings:

User Name:	admin
Password:	admin
Enable DHCP:	Yes (if WAN cable is plugged in)
IP address:	http://router.asus.com (or 192.168.1.1)
Domain Name:	(Blank)
Subnet Mask:	255.255.255.0
DNS Server 1:	192.168.1.1
DNS Server 2:	(Blank)
SSID (2.4GHz):	ASUS_XX_2G
SSID (5GHz):	ASUS_XX_5G
SSID (6GHz):	ASUS_XX_6G

Firmware upgrade failed.

Launch the rescue mode and run the Firmware Restoration utility. Refer to section **5.2 Firmware Restoration** on how to use the Firmware Restoration utility.

Cannot access Web GUI

Before configuring your wireless router, do the steps described in this section for your host computer and network clients.

A. Disable the proxy server, if enabled.

Windows®

1. Click **Start > Internet Explorer** to launch the browser.
2. Click **Tools > Internet options > Connections tab > LAN settings**.

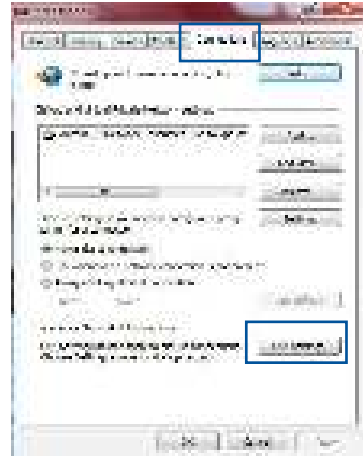

3. From the Local Area Network (LAN) Settings screen, untick **Use a proxy server for your LAN**.
4. Click **OK** when done.

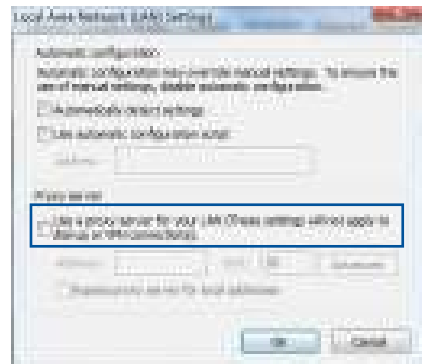

MAC OS

1. From your Safari browser, click **Safari > Preferences > Advanced > Change Settings...**
2. From the Network screen, deselect **FTP Proxy** and **Web Proxy (HTTP)**.
3. Click **Apply Now** when done.

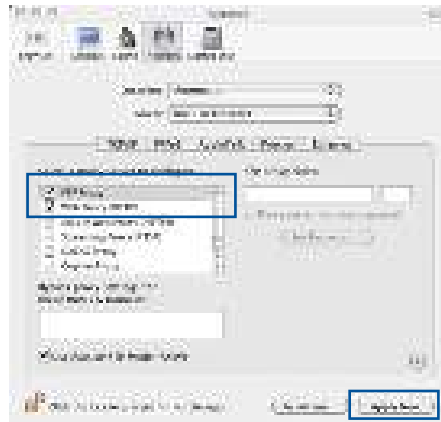

NOTE: Refer to your browser's help feature for details on disabling the proxy server.

B. Set the TCP/IP settings to automatically obtain an IP address.

Windows®

1. Click **Start > Control Panel > Network and Sharing Center**, then click the network connection to display its status window.

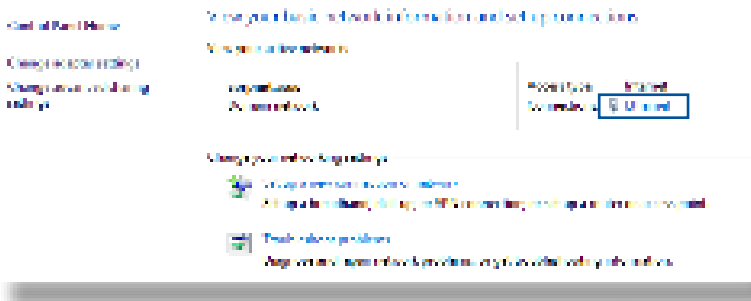

2. Click **Properties** to display the Ethernet Properties window.



3. Select **Internet Protocol Version 4 (TCP/IPv4)** or **Internet Protocol Version 6 (TCP/IPv6)**, then click **Properties**.

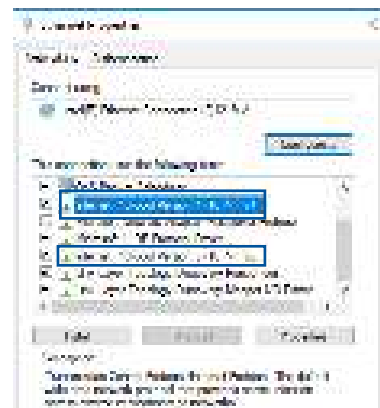

4. To obtain the IPv4 IP settings automatically, tick **Obtain an IP address automatically**.

To obtain the IPv6 IP settings automatically, tick **Obtain an IPv6 address automatically**.

5. Click **OK** when done.



MAC OS

1. Click the Apple icon  located on the top left of your screen.
2. Click **System Preferences > Network > Configure...**
3. From the **TCP/IP** tab, select **Using DHCP** in the **Configure IPv4** dropdown list.
4. Click **Apply Now** when done.

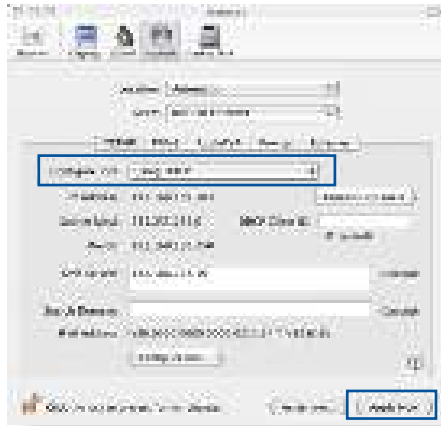

NOTE: Refer to your operating system's help and support feature for details on configuring your computer's TCP/IP settings.

C. Disable the dial-up connection, if enabled.

Windows®

1. Click **Start > Internet Explorer** to launch the browser.
2. Click **Tools > Internet options > Connections** tab.
3. Tick **Never dial a connection.**
4. Click **OK** when done.

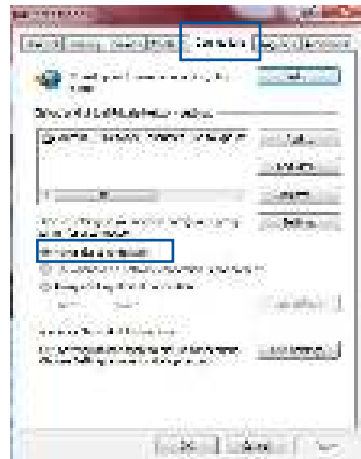

NOTE: Refer to your browser's help feature for details on disabling the dial-up connection.

Appendices

Notices

ASUS Recycling/Takeback Services

ASUS recycling and takeback programs come from our commitment to the highest standards for protecting our environment. We believe in providing solutions for you to be able to responsibly recycle our products, batteries, other components, as well as the packaging materials. Please go to <http://csr.asus.com/english/Takeback.htm> for the detailed recycling information in different regions.

REACH

Complying with the REACH (Registration, Evaluation, Authorisation, and Restriction of Chemicals) regulatory framework, we published the chemical substances in our products at ASUS REACH website at <http://csr.asus.com/english/REACH.htm>

Federal Communications Commission Statement

This device complies with Part 15 of the FCC Rules. Operation is subject to the following two conditions:

- This device may not cause harmful interference.
- This device must accept any interference received, including interference that may cause undesired operation.

This equipment has been tested and found to comply with the limits for a class B digital device, pursuant to part 15 of the FCC Rules. These limits are designed to provide reasonable protection against harmful interference in a residential installation.

This equipment generates, uses and can radiate radio frequency energy and, if not installed and used in accordance with the instructions, may cause harmful interference to radio communications. However, there is no guarantee that interference will not occur in a particular installation. If this equipment does cause harmful interference to radio or television reception, which can be determined by turning the equipment off and on, the user is encouraged to try to correct the interference by one or more of the following measures:

- Reorient or relocate the receiving antenna.
- Increase the separation between the equipment and receiver.
- Connect the equipment into an outlet on a circuit different from that to which the receiver is connected.
- Consult the dealer or an experienced radio/TV technician for help.

WARNING! Any changes or modifications not expressly approved by the party responsible for compliance could void the user's authority to operate the equipment.

Prohibition of Co-location

This device and its antenna(s) must not be co-located or operating in conjunction with any other antenna or transmitter.

IMPORTANT NOTE:

Radiation Exposure Statement: This equipment complies with FCC radiation exposure limits set forth for an uncontrolled environment. End users must follow the specific operating instructions for satisfying RF exposure compliance. To maintain compliance with FCC exposure compliance requirement, please follow operation instruction as documented in this manual.

WARNING! This equipment must be installed and operated in accordance with provided instructions and the antenna(s) used for this transmitter must be installed to provide a separation distance of at least 20 cm from all persons and must not be co-located or operating in conjunction with any other antenna or transmitter.

Safety Notices

- Use this product in environments with ambient temperatures between 0°C(32°F) and 40°C(104°F).
- Refer to the rating label on the bottom of your product and ensure your power adapter complies with this rating.
- DO NOT place on uneven or unstable work surfaces. Seek servicing if the casing has been damaged.
- DO NOT place or drop objects on top and do not shove any foreign objects into the product.
- DO NOT expose to or use near liquids, rain, or moisture. DO NOT use the modem during electrical storms.
- DO NOT cover the vents on the product to prevent the system from getting overheated.
- DO NOT use damaged power cords, accessories, or other peripherals.
- If the Adapter is broken, do not try to fix it by yourself. Contact a qualified service technician or your retailer.
- To prevent electrical shock hazard, disconnect the power cable from the electrical outlet before relocating the system.

Safety Notices

- Utilisez ce produit dans un environnement dont la température ambiante est comprise entre 0°C (32°F) et 40°C (104°F).
- Référez-vous à l'étiquette située au dessous du produit pour vérifier que l'adaptateur secteur répond aux exigences de tension.
- NE PAS placer sur une surface irrégulière ou instable. Contactez le service après-vente si le châssis a été endommagé.
- NE PAS placer, faire tomber ou insérer d'objets sur/dans le produit.
- NE PAS exposer l'appareil à la pluie ou à l'humidité, tenez-le à distance des liquides. NE PAS utiliser le modem lors d'un orage.
- NE PAS bloquer les ouvertures destinées à la ventilation du système pour éviter que celui-ci ne surchauffe.

- NE PAS utiliser de cordons d'alimentation, d'accessoires ou autres périphériques endommagés.
- Si l'adaptateur est endommagé, n'essayez pas de le réparer vous-même. Contactez un technicien électrique qualifié ou votre revendeur.
- Pour éviter tout risque de choc électrique, débranchez le câble d'alimentation de la prise électrique avant de toucher au système.

Radiation Exposure Statement

Déclaration d'exposition aux radiations

This equipment complies with IC radiation exposure limits set forth for an uncontrolled environment. This equipment should be installed and operated with minimum distance 31cm between the radiator & your body.

Cet équipement est conforme aux limites d'exposition aux rayonnements IC établies pour un environnement non contrôlé. Cet équipement doit être installé et utilisé avec un minimum de 31cm de distance entre la source de rayonnement et votre corps.

This device contains licence-exempt transmitter(s)/receiver(s) that comply with Innovation, Science and Economic Development Canada's licence-exempt RSS(s). Operation is subject to the following two conditions:

- (1) This device may not cause interference.
- (2) This device must accept any interference, including interference that may cause undesired operation of the device.

Cet appareil contient des émetteurs / récepteurs exempts de licence qui sont conformes au (x) RSS (s) exemptés de licence d'Innovation, Sciences et Développement économique Canada. L'opération est soumise aux deux conditions suivantes:

- (1) Cet appareil ne doit pas provoquer d'interférences.*
- (2) Cet appareil doit accepter toute interférence, y compris les interférences susceptibles de provoquer un fonctionnement indésirable de l'appareil.*

This radio transmitter [IC: 3568A-RTHR00] has been approved by Innovation, Science and Economic Development Canada to operate with the antenna types listed below, with the maximum permissible gain indicated. Antenna types not included in this list that have a gain greater than the maximum gain indicated for any type listed are strictly prohibited for use with this device.

Le présent émetteur radio (IC: 3568A-RTHR00) a été approuvé par Innovation, Sciences et Développement économique Canada pour fonctionner avec les types d'antenne énumérés ci-dessous et ayant un gain admissible maximal d'antenne. Les types d'antennes non inclus dans cette liste qui ont un gain supérieur au gain maximal indiqué pour tout type listé sont strictement interdits pour une utilisation avec cet appareil.

Set	Ant.	Port				Brand	P/N	Type	Connector	Gain (dBi)			
		2.4 GHz	5GHz B1/B2	5GHz B3	5GHz B4					2.4 GHz	5GHz B1/B2	5GHz B3	5GHz B4
1	1	1	-	4	4	WHA YU	C660-510413-A	Dipole	Reverse SMA Plug	1.9	-	2.3	1.9
	2	2	-	3	3	WHA YU	C660-510413-A	Dipole	Reverse SMA Plug	1.9	-	2.3	1.9
	3	3	-	2	2	WHA YU	C660-510413-A	Dipole	Reverse SMA Plug	1.9	-	2.3	1.9
	4	4	-	1	1	WHA YU	C660-510413-A	Dipole	Reverse SMA Plug	1.9	-	2.3	1.9
	5	-	1	-	-	WHA YU	C660-510413-A	Dipole	Reverse SMA Plug	-	2.3	-	-
	6	-	2	-	-	WHA YU	C660-510413-A	Dipole	Reverse SMA Plug	-	2.3	-	-
	7	-	3	-	-	WHA YU	C660-510413-A	Dipole	Reverse SMA Plug	-	2.3	-	-
	8	-	4	-	-	WHA YU	C660-510413-A	Dipole	Reverse SMA Plug	-	2.3	-	-
2	1	1	-	4	4	WHA YU	C660-510431-A	Dipole	Reverse SMA Plug	1.9	-	2.3	1.9
	2	2	-	3	3	WHA YU	C660-510431-A	Dipole	Reverse SMA Plug	1.9	-	2.3	1.9
	3	3	-	2	2	WHA YU	C660-510431-A	Dipole	Reverse SMA Plug	1.9	-	2.3	1.9
	4	4	-	1	1	WHA YU	C660-510431-A	Dipole	Reverse SMA Plug	1.9	-	2.3	1.9
	5	-	1	-	-	WHA YU	C660-510431-A	Dipole	Reverse SMA Plug	-	2.3	-	-
	6	-	2	-	-	WHA YU	C660-510431-A	Dipole	Reverse SMA Plug	-	2.3	-	-
	7	-	3	-	-	WHA YU	C660-510431-A	Dipole	Reverse SMA Plug	-	2.3	-	-
	8	-	4	-	-	WHA YU	C660-510431-A	Dipole	Reverse SMA Plug	-	2.3	-	-
3	1	1	-	4	4	PSA	RFDPA161000 SBL8801	Dipole	Reverse SMA Plug	1.9	-	2.3	1.9
	2	2	-		3	PSA	RFDPA161000 SBL8801	Dipole	Reverse SMA Plug	1.9	-	2.3	1.9
	3	3	-	2	2	PSA	RFDPA161000 SBL8801	Dipole	Reverse SMA Plug	1.9	-	2.3	1.9
	4	4	-	1	1	PSA	RFDPA161000 SBL8801	Dipole	Reverse SMA Plug	1.9	-	2.3	1.9
	5	-	1	-	-	PSA	RFDPA161000 SBL8801	Dipole	Reverse SMA Plug	-	2.3	-	-
	6	-	2	-	-	PSA	RFDPA161000 SBL8801	Dipole	Reverse SMA Plug	-	2.3	-	-
	7	-	3	-	-	PSA	RFDPA161000 SBL8801	Dipole	Reverse SMA Plug	-	2.3	-	-
	8	-	4	-	-	PSA	RFDPA161000 SBL8801	Dipole	Reverse SMA Plug	-	2.3	-	-

Dynamic Frequency Selection (DFS) for devices operating in the bands 5250- 5350 MHz, 5470-5600 MHz and 5650-5725 MHz.

Sélection dynamique de fréquences (DFS) pour les dispositifs fonctionnant dans les bandes 5250-5350 MHz, 5470-5600 MHz et 5650-5725 MHz.

The device for operation in the band 5150–5250 MHz is only for indoor use to reduce the potential for harmful interference to co-channel mobile satellite systems.

les dispositifs fonctionnant dans la bande 5150-5250 MHz sont réservés uniquement pour une

utilisation à l'intérieur afin de réduire les risques de brouillage préjudiciable aux systèmes de satellites mobiles utilisant les mêmes canaux.

The maximum antenna gain permitted for devices in the bands 5250-5350 MHz and 5470-5725 MHz shall be such that the equipment still complies with the e.i.r.p. limit.

le gain maximal d'antenne permis pour les dispositifs utilisant les bandes 5250-5350 MHz et 5470-5725 MHz doit se conformer à la limite de p.i.r.e.

The maximum antenna gain permitted for devices in the band 5725-5850 MHz shall be such that the equipment still complies with the e.i.r.p. limits specified for point-to-point and non-point-to-point operation as appropriate.

le gain maximal d'antenne permis (pour les dispositifs utilisant la bande 5725-5850 MHz) doit se conformer à la limite de p.i.r.e. spécifiée pour l'exploitation point à point et non point à point, selon le cas.

For indoor use only.

Pour une utilisation en intérieur uniquement.

IMPORTANT NOTE:

IC Radiation Exposure Statement:

This equipment complies with IC RSS-102 radiation exposure limits set forth for an uncontrolled environment. This equipment should be installed and operated with minimum distance 31cm between the radiator & your body.

Cet équipement est conforme aux limites d'exposition aux rayonnements IC établies pour un environnement non contrôlé. Cet équipement doit être installé et utilisé avec un minimum de 31 cm de distance entre la source de rayonnement et votre corps.

VCCI: Japan Compliance Statement

この装置は、情報処理装置等電波障害自主規制協議会（VCCI）の基準に基づくクラスB情報技術装置です。この装置は、家庭環境で使用することを目的としていますが、ラジオやテレビジョン受信機に近接して使用されると、受信障害を引き起こすことがあります。

取扱説明書に従って正しい取り扱いをして下さい。

5.3GHz 帯 *W53 (5,250-5,350MHz) は屋内利用に限定されています。

KC: Korea Warning Statement

B급 기기 (가정용 방송통신기자재)	이 기기는 가정용(B급)으로 전자파적합등록을 한 기기로서 주로 가정에서 사용하는 것을 목적으로 하며, 모든 지역에서 사용할 수 있습니다.
Class B equipment (For Home Use Broadcasting & Communication Equipment)	This equipment is home use (Class B) electromagnetic wave suitability and to be used mainly at home and it can be used in all areas.

「產品之限用物質含有情況」之相關資訊，請參考下表：

單元	限用物質及其化學符號					
	鉛 (Pb)	汞 (Hg)	鎘 (Cd)	六價鉻 (Cr ⁶⁺)	多溴聯苯 (PBB)	多溴二苯醚 (PBDE)
印刷電路板及電子組件	-	○	○	○	○	○
結構組件 (金屬 / 塑膠)	○	○	○	○	○	○
其他組件 (如天線/ 指示燈/ 連接線)	○	○	○	○	○	○
其他及其配件 (如電源供應器)	-	○	○	○	○	○
備考1. “○” 係指該項限用物質之百分比含量未超出百分比含量基準值。						
備考2. “-” 係指該項限用物質為排除項目。						

DFS 警語

操作在 5.15-5.35/5.47-5.85GHz 之無線資訊傳輸設備 (802.11a/ac 產品)，應避免影響附近雷達系統之操作。

MPE

本產品電磁波曝露量 (MPE) 標準值 $1\text{mW}/\text{cm}^2$ ，送測產品實測值為 XXXmW/cm^2 ，建議使用時至少距離人體 XXcm 。

安全說明：

- 請在溫度為 0°C (32°F) 至 40°C (104°F) 之間的環境中使用本產品。
- 請依照產品上的電源功率貼紙說明使用正確的電源變壓器，如果使用錯誤規格的電源變壓器有可能會造成內部零件的損毀。
- 請勿將產品放置於不平坦或不穩定的表面，若產品的機殼毀損，請聯絡維修服務人員。
- 請勿在產品上放置其他物品，請勿將任何物品塞入產品內，以避免引起元件短路或電路損毀。
- 請保持機器在乾燥的環境下使用，雨水、溼氣、液體等含有礦物質將會腐蝕電子線路，請勿在雷電天氣下使用數據機。
- 請勿堵塞產品的通風孔，以避免因散熱不良而導致系統過熱。
- 請勿使用破損的電源線、附件或其他周邊產品。
- 如果電源已毀損，請不要嘗試自行修復，請將其交給專業技術服務人員或經銷商來處理。
- 為了防止電擊風險，在搬動主機之前，請先將電源線插頭暫時從電源插座上拔除。



电子电气产品有害物质限制使用标识要求：图中之数字为产品之环保使用期限。仅指电子电气产品中含有的有害物质不致发生外泄或突变从而对环境造成污染或对人身、财产造成严重损害的期限。

产品中有害物质的名称及含量

部件名称	有害物质					
	铅(Pb)	汞(Hg)	镉(Cd)	六价铬(Cr(VI))	多溴联苯(PBB)	多溴二苯醚(PBDE)
印刷电路板及其电子组件	×	○	○	○	○	○
外壳	○	○	○	○	○	○
电源适配器	×	○	○	○	○	○
外部信号连接头及线材	×	○	○	○	○	○
中央处理器与内存	×	○	○	○	○	○
本表格依据 SJ/T 11364 的规定编制。 ○：表示该有害物质在该部件所有均质材料中的含量均在 GB/T 26572 规定的限量要求以下。 ×：表示该有害物质至少在该部件的某一均质材料中的含量超出 GB/T 26572 规定的限量要求，然该部件仍符合欧盟指令 2011/65/EU 的规范。 备注：此产品所标示之环保使用期限，系指在一般正常使用状况下。						

安全说明：

- 请在温度为 0° C (32° F) 至 40° C (104° F) 之间的环境中使用本产品。
- 请依照产品上的电源功率贴纸说明使用正确的电源适配器，如果试用错误规格的电源适配器可能会造成内部零件的损坏。
- 请勿将产品放置于不平坦或不稳定的表面，若产品的外壳损坏，请联系维修服务人员。
- 请勿在产品上放置其他物品，请勿将任何物品塞入产品内，以避免引起组件短路或电路损坏。
- 请保持机器在干燥的环境下使用，雨水、湿气、液体等含有矿物质会腐蚀电子线路，请勿在雷电天气下使用调制解调器。
- 请勿堵塞产品的通风孔，避免因散热不良而导致系统过热。
- 请勿使用破损的电源线、附件或其他周边产品。
- 如果电源已损坏，请不要尝试自行修复，请将其交给专业技术服务人员或经销商来处理。
- 为了防止电击风险，在搬动主机前，请先将电源线插头暂时从电源插座上拔除。



UA.TR.028

Precautions for the use of the device

- a. Pay particular attention to the personal safety when use this device in airports, hospitals, gas stations and professional garages.
- b. Medical device interference: Maintain a minimum distance of at least 15 cm (6 inches) between implanted medical devices and ASUS products in order to reduce the risk of interference.
- c. Kindly use ASUS products in good reception conditions in order to minimize the radiation's level.
- d. Keep the device away from pregnant women and the lower abdomen of the teenager.

Précautions d'emploi de l'appareil

- a. Soyez particulièrement vigilant quant à votre sécurité lors de l'utilisation de cet appareil dans certains lieux (les avions, les aéroports, les hôpitaux, les stations-service et les garages professionnels).
- b. Évitez d'utiliser cet appareil à proximité de dispositifs médicaux implantés. Si vous portez un implant électronique (stimulateurs cardiaques, pompes à insuline, neurostimulateurs...), veuillez impérativement respecter une distance minimale de 15 centimètres entre cet appareil et votre corps pour réduire les risques d'interférence.
- c. Utilisez cet appareil dans de bonnes conditions de réception pour minimiser le niveau de rayonnement. Ce n'est pas toujours le cas dans certaines zones ou situations, notamment dans les parkings souterrains, dans les ascenseurs, en train ou en voiture ou tout simplement dans un secteur mal couvert par le réseau.
- d. Tenez cet appareil à distance des femmes enceintes et du bas-ventre des adolescents.

Условия эксплуатации:

- Температура эксплуатации устройства: 0-40 °С. Не используйте устройство в условиях экстремально высоких или низких температур.
- Не размещайте устройство вблизи источников тепла, например, рядом с микроволновой печью, духовым шкафом или радиатором.
- Использование несовместимого или несертифицированного адаптера питания может привести к возгоранию, взрыву и прочим опасным последствиям.
- При подключении к сети электропитания устройство следует располагать близко к розетке, к ней должен осуществляться беспрепятственный доступ.
- Утилизация устройства осуществляется в соответствии с местными законами и положениями. Устройство по окончании срока службы должны быть переданы в сертифицированный пункт сбора для вторичной переработки или правильной утилизации.
- Данное устройство не предназначено для детей. Дети могут пользоваться устройством только в присутствии взрослых.
- Не выбрасывайте устройство и его комплектующие вместе с обычными бытовыми отходами.



India RoHS

This product complies with the "India E-Waste (Management) Rules, 2016" and prohibits use of lead, mercury, hexavalent chromium, polybrominated biphenyls (PBBs) and polybrominated diphenyl ethers (PBDEs) in concentrations exceeding 0.1 % by weight in homogenous materials and 0.01 % by weight in homogenous materials for cadmium, except for the exemptions listed in Schedule II of the Rule.

הוראות בטיחות לשימוש במוצר

יש לפעול ע"פ כללי הבטיחות הבאים בעת שימוש במוצר:

- ודא שלמות ותקינות התקע ו/או כבל החשמל.
- אין להכניס או להוציא את התקע מרשת החשמל בידיים רטובות.
- באם המוצר מופעל ע"י מטען חיצוני, אין לפתוח את המטען, במקרה של בעיה כלשהי, יש לפנות למעבדת השירות הקרובה.
- יש להרחיק את המוצר והמטען מנוזלים.
- במקרה של ריח מוזר, רעשים שמקורם במוצר ו/או במטען/ספק כוח, יש לנתקו מיידית מרשת החשמל ולפנות למעבדת שירות.
- המוצר והמטען/ספק כוח מיועד לשימוש בתוך המבנה בלבד, לא לשימוש חיצוני ולא לשימוש בסביבה לחה.
- אין לחתוך, לשבור, ולעקם את כבל החשמל.
- אין להניח חפצים על כבל החשמל או להניח לו להתחמם יתר על המידה, שכן הדבר עלול לגרום לנזק, דליקה או התחשמלות.
- לפני ניקוי המוצר ו/או המטען יש לנתקו מרשת החשמל.
- יש לאפשר גישה נוחה לחיבור וניתוק פתיל הזינה מרשת החשמל
- יש להקפיד ולתחזק את התקן הניתוק במצב תפעולי מוכן לשימוש

אזהרה:

- אין להחליף את כבל הזינה בתחליפים לא מקוריים, חיבור לקוי עלול לגרום להתחשמלות המשתמש.
- בשימוש על כבל מאריך יש לוודא תקינות מוליך הארקה שבכבל.

AEEE Yönetmeliğine Uygundur. IEEE Yönetmeliğine Uygundur.

- Bu Cihaz Türkiye analog şebekelerde çalışabilecek şekilde tasarlanmıştır.
- Cihazın ayrıntılı kurulum rehberi kutu içeriğinden çıkan CD içerisinde. Cihazın kullanıcı arayüzü Türkçe'dir.
- Cihazın kullanılması planlanan ülkelerde herhangi bir kısıtlaması yoktur. Ülkeler simgeler halinde kutu üzerinde belirtilmiştir.



Manufacturer	ASUSTek Computer Inc. Tel: +886-2-2894-3447 Address: 1F, No. 15, LIDE RD., PEITOU DIST., TAIPEI CITY 112, TAIWAN
Authorised representative in United Kingdom	ASUSTEK (UK) LIMITED Tel./FAX No.: +44-01442-202-700 / +44-01442-245-882 Address: 1 st Floor, Sackville House, 143-149 Fenchurch Street, London, EC3M 6BL, England, United Kingdom
Authorised representative in Europe	ASUS Computer GmbH Address: HARKORT STR. 21-23, 40880 RATINGEN, GERMANY
Authorised distributors in Turkey	BOGAZICI BILGISAYAR TICARET VE SANAYI A.S. Tel./FAX No.: +90 212 331 10 00 / +90 212 332 28 90 Address: ESENTEPE MAH. BUYUKDERE CAD. ERCAN HAN B BLOK NO.121 SISLI, ISTANBUL 34394
	CIZGI Elektronik San. Tic. Ltd. Sti. Tel./FAX No.: +90 212 356 70 70 / +90 212 356 70 69 Address: GURSEL MAH. AKMAN SK.47B 1 KAGITHANE/ ISTANBUL
	KOYUNCU ELEKTRONİK BİLGİ İŞLEM SİST. SAN. VE DİŞ TİC. A.S. Tel. No.: +90 216 5288888 Address: EMEK MAH.ORDU CAD. NO:18, SARIGAZI, SANCAKTEPE ISTANBUL
	ENDEKS BİLİŞİM SAN VE DİŞ TİC LTD ŞTİ Tel./FAX No.: +90 216 523 35 70 / +90 216 523 35 71 Address: NECİP FAZİL BULVARI, KEYAP CARSI SITESİ, G1 BLOK, NO:115 Y.DUDULLU, UMRANIYE, ISTANBUL
	PENTA TEKNOLOJİ URUNLERİ DAGITIM TICARET A.S Tel./FAX No.: +90 216 528 0000 Address: ORGANİZE SANAYİ BOLGESİ NATO YOLU 4.CADDE NO:1 UMRANIYE, ISTANBUL 34775

UKCA statement

Simplified UKCA Declaration of Conformity

ASUSTek Computer Inc. hereby declares that this device is in compliance with the essential requirements and other relevant provisions of The Radio Equipment Regulations 2017 (S.I. 2017/1206). Full text of UKCA declaration of conformity is available at <https://www.asus.com/support/>.

The WiFi operating in the band 5150-5350 MHz shall be restricted to indoor use for the country listed below:



English

CE statement

Simplified EU Declaration of Conformity

ASUSTek Computer Inc. hereby declares that this device is in compliance with the essential requirements and other relevant provisions of Directive 2014/53/EU. Full text of EU declaration of conformity is available at https://www.asus.com/Networking/ROG-Rapture-GT-AXE11000/HelpDesk_Declaration/.

Declaration of Conformity for Ecodesign directive 2009/125/EC

Testing for eco-design requirements according to (EC) No 1275/2008 and (EU) No 801/2013 has been conducted. When the device is in Networked Standby Mode, its I/O and network interface are in sleep mode and may not work properly. To wake up the device, press the Wi-Fi on/off, LED on/off, reset, or WPS button.

This equipment complies with EU radiation exposure limits set forth for an uncontrolled environment. This equipment should be installed and operated with minimum distance 20 cm between the radiator & your body.

All operational modes:

2.4GHz: 802.11b, 802.11g, 802.11n (HT20), 802.11n (HT40), 802.11ac (VHT20), 802.11ac (VHT40)

5GHz: 802.11a, 802.11n (HT20), 802.11n (HT40), 802.11ac (VHT20), 802.11ac (VHT40), 802.11ac (VHT80)

The frequency, mode and the maximum transmitted power in EU are listed below:

2412-2472MHz (802.11g 6Mbps): 19.81 dBm

5180-5240MHz (802.11ac VHT20 MCS0): 20.1 dBm

5260-5320MHz (802.11ac VHT40 MCS0): 21.31 dBm

5500-5700MHz (802.11ac VHT80 MCS0): 27.48 dBm

The device is restricted to indoor use only when operating in the 5150 to 5350 MHz frequency range.

The adapter shall be installed near the equipment and shall be easily accessible.

	AT	BE	BG	CZ	DK	EE	FR
	DE	IS	IE	IT	EL	ES	CY
	LV	LI	LT	LU	HU	MT	NL
	NO	PL	PT	RO	SI	SK	TR
	FI	SE	CH	HR	UK(NI)		

Safety Notices

- Use this product in environments with ambient temperatures between 0°C(32°F) and 40°C(104°F).
- Refer to the rating label on the bottom of your product and ensure your power adapter complies with this rating.
- DO NOT place on uneven or unstable work surfaces. Seek servicing if the casing has been damaged.
- DO NOT place or drop objects on top and do not shove any foreign objects into the product.
- DO NOT expose to or use near liquids, rain, or moisture. DO NOT use the modem during electrical storms.
- DO NOT cover the vents on the product to prevent the system from getting overheated.
- DO NOT use damaged power cords, accessories, or other peripherals.
- If the Adapter is broken, do not try to fix it by yourself. Contact a qualified service technician or your retailer.
- To prevent electrical shock hazard, disconnect the power cable from the electrical outlet before relocating the system.

Bulgarian CE statement

Опростена декларация за съответствие на ЕС

С настоящото ASUSTeK Computer Inc. декларира, че това устройство е в съответствие със съществените изисквания и другите приложими постановления на Директива 2014/53/ЕС. Пълният текст на декларацията за съответствие на ЕС е достъпен на адрес https://www.asus.com/Networking/ROG-Rapture-GT-AXE11000/HelpDesk_Declaration/.

Декларация за съответствие за Директива за екодизайна 2009/125/ЕО

Проведени са тестове за съвместимост с изискванията за екодизайн съгласно (ЕО) No. 1275/2008 и (ЕО) No. 801/2013. Когато устройството е в Networked Standby Mode (Режим на готовност на мрежа), I/O и мрежовият интерфейс са в спящ режим и може да не работят както трябва. За да събудите устройството, натиснете Wi-Fi on/off (Wi-Fi вкл./изкл.), LED on/off (LED вкл./изкл.), reset (нулиране) или бутоната WPS.

Това устройство е в съответствие с границите за радиочестотно облъчване, установени от ЕС за неконтролирана среда. Това оборудване трябва да се инсталира и използва при разстояние най-малко 20 cm 20 cm между излъчващото тяло и човешкото тяло.

Всички режими на работа:

2.4GHz: 802.11b, 802.11g, 802.11n (HT20), 802.11n (HT40), 802.11ac (VHT20), 802.11ac (VHT40)

5GHz: 802.11a, 802.11n (HT20), 802.11n (HT40), 802.11ac (VHT20), 802.11ac (VHT40), 802.11ac (VHT80)

По-долу са посочени честотата, режимът и максималното предавано запазване в ЕС.

2412-2472MHz (802.11g 6Mbps): 19.81 dBm

5180-5240MHz (802.11ac VHT20 MCS0): 20.1 dBm

5260-5320MHz (802.11ac VHT40 MCS0): 21.31 dBm

5500-5700MHz (802.11ac VHT80 MCS0): 27.48 dBm

Устройството е ограничено за използване в помещения единствено, когато оперира в честотен диапазон от 5150 до 5350 MHz.

Адаптерът трябва да се намира в близост до оборудването и да бъде лесно достъпен.

	AT	BE	BG	CZ	DK	EE	FR
	DE	IS	IE	IT	EL	ES	CY
	LV	LI	LT	LU	HU	MT	NL
	NO	PL	PT	RO	SI	SK	TR
	FI	SE	CH	HR	UK(NI)		

Safety Notices

- Използвайте този продукт при температура на околната среда от 0°C (32°F) до 40°C (104°F).
- Вижте етикета на долната страна на Вашия продукт и се уверете, че Вашият адаптер отговаря на изискванията.
- НЕ поставяйте върху неравни или нестабилни работни повърхности. Обърнете се към сервиз, ако корпусът се повреди.
- НЕ поставяйте, не пускайте отгоре и не пъхайте никакви чужди предмети в продукта.
- НЕ излагайте на и не използвайте в близост до течности, дъжд или влага. НЕ използвайте модема по време на гръмотевични бури.
- НЕ покривайте вентилационните отвори на продукта, за да предотвратите прегряване на системата.
- НЕ използвайте повредени захранващи кабели, аксесоари или други периферни устройства.
- Ако адаптерът е повреден, не се опитвайте да го ремонтирате сами. Свържете се с квалифициран техник или с Вашия доставчик.
- За да избегнете риск от токов удар, изключете захранващия кабел от електрическата мрежа преди да преместите системата.

Croatian CE statement

Pojednostavljena EU Izjava o sukladnosti

ASUSTek Computer Inc. ovime izjavljuje da je uređaj sukladan s osnovnim zahtjevima i ostalim važnim odredbama direktive 2014/53/EU. Cijeli tekst EU izjave o sukladnosti dostupan je na https://www.asus.com/Networking/ROG-Rapture-GT-AXE11000/HelpDesk_Declaration/.

Izjava o sukladnosti za direktivu o ekodizajnu 2009/125/EZ

Provedeno je testiranje zahtjeva na ekodizajn u skladu s (EC) No 1275/2008 i (EU) No 801/2013. Kada je uređaj u umreženom načinu mirovanja, njegovi ulazi/izlazi i mrežno sučelje su također u načinu mirovanja i možda neće ispravno raditi. Za pokretanje uređaja pritisnite tipku za uključivanje/isključivanje Wi-Fi uređaja, uključivanje/isključivanje LED-a, ponovno postavljanje ili gumb za WPS.

Ova oprema sukladna je EU ograničenjima o izloženosti zračenju u nekontroliranom okruženju. Ovaj uređaj se mora postaviti i koristiti na minimalnoj udaljenosti od 20 cm između radijatora i vašeg tijela.

Svi načini rada:

2.4GHz: 802.11b, 802.11g, 802.11n (HT20), 802.11n (HT40), 802.11ac (VHT20), 802.11ac (VHT40)

5GHz: 802.11a, 802.11n (HT20), 802.11n (HT40), 802.11ac (VHT20), 802.11ac (VHT40), 802.11ac (VHT80)

U nastavku su navedeni frekvencija, način rada i maksimalna emitirana snaga u EU:

2412-2472MHz (802.11g 6Mbps): 19.81 dBm

5180-5240MHz (802.11ac VHT20 MCS0): 20.1 dBm

5260-5320MHz (802.11ac VHT40 MCS0): 21.31 dBm

5500-5700MHz (802.11ac VHT80 MCS0): 27.48 dBm

Uređaj je ograničen na uporabu u zatvorenim prostorima samo pri radu u frekvencijskom rasponu od 5150 do 5350 MHz.

Adapter se mora instalirati blizu uređaja i mora biti lako dostupan.

	AT	BE	BG	CZ	DK	EE	FR
	DE	IS	IE	IT	EL	ES	CY
	LV	LI	LT	LU	HU	MT	NL
	NO	PL	PT	RO	SI	SK	TR
	FI	SE	CH	HR	UK(NI)		

Safety Notices

- Ovaj proizvod koristite u okruženjima s temperaturom okruženja između 0 °C (32 °F) i 40 °C (104 °F).
- Pogledajte nazivnu oznaku na donjem dijelu proizvoda kako biste provjerili je li adapter sukladan.
- NE postavljajte uređaj na neravne i nestabilne radne površine. U slučaju oštećenja kućišta, zatražite pomoć servisa.
- NEMOJTE postavljati ili spuštati predmete na gornji dio uređaja i nemojte umetati strane predmete u proizvod.
- NE izlažite i ne upotrebljavajte uređaj u blizini tekućina, kiše ili vlage. NEMOJTE koristiti modem tijekom električne oluje.
- NEMOJTE prekrivati otvore na proizvodu kako ne biste uzrokovali pregrijavanje sustava.
- Nemojte koristiti oštećene kabele za napajanje, dodatnu opremu i ostale vanjske uređaje.
- Ako je adapter oštećen, nemojte ga popravljati sami. Obratite se kvalificiranom servisnom tehničaru ili dobavljaču.
- Kako biste spriječili opasnost od električnog udara, iskopčajte kabel iz električne utičnice prije premještanja sustava.

Czech CE statement

Zjednodušené prohlášení o shodě s EU

Společnost ASUSTek Computer Inc. tímto prohlašuje, že toto zařízení splňuje základní požadavky a další příslušná ustanovení směrnice 2014/53/EU. Plné znění prohlášení o shodě EU je k dispozici na adrese https://www.asus.com/Networking/ROG-Rapture-GT-AXE11000/HelpDesk_Declaration/.

Prohlášení o shodě se směrnicí o ekodesignu 2009/125/ES

Bylo provedeno testování požadavků na ekodesign podle směrnice (ES) č. 1275/2008 a (EU) č. 801/2013. Když se toto zařízení nachází v pohotovostním síťovém režimu, jeho vstupy/výstupy a síťové rozhraní jsou v režimu spánku a nemusí fungovat správně. Zařízení lze probudit vypínačem Wi-Fi, vypínačem LED, resetovacím tlačítkem nebo tlačítkem WPS.

Toto zařízení vyhovuje limitům EU pro vystavení vyzařování stanoveným pro neřízené prostředí. Toto zařízení musí být nainstalováno a provozováno v minimální vzdálenosti 20 cm mezi zářičem a vaším tělem.

Všechny provozní režimy:

2.4GHz: 802.11b, 802.11g, 802.11n (HT20), 802.11n (HT40), 802.11ac (VHT20), 802.11ac (VHT40)

5GHz: 802.11a, 802.11n (HT20), 802.11n (HT40), 802.11ac (VHT20), 802.11ac (VHT40), 802.11ac (VHT80)

Niže je uvedena frekvence, režim a maximální vysílaný výkon v EU:

2412-2472MHz (802.11g 6Mbps): 19.81 dBm

5180-5240MHz (802.11ac VHT20 MCS0): 20.1 dBm

5260-5320MHz (802.11ac VHT40 MCS0): 21.31 dBm

5500-5700MHz (802.11ac VHT80 MCS0): 27.48 dBm

Při provozu ve frekvenčním rozsahu 5 150 až 5 350 MHz je používání tohoto zařízení omezeno pouze na vnitřní prostory.

Používaný adaptér se musí nacházet v blízkosti zařízení a musí být snadno přístupný.

	AT	BE	BG	CZ	DK	EE	FR
	DE	IS	IE	IT	EL	ES	CY
	LV	LI	LT	LU	HU	MT	NL
	NO	PL	PT	RO	SI	SK	TR
	FI	SE	CH	HR	UK(NI)		

Safety Notices

- Počítač používejte jen při teplotě okolí 0 °C (32 °F) až 40 °C (104 °F).
- Informace naleznete na energetickém štítku na spodní straně vašeho produktu. Ujistěte se, že napájecí adaptér je v souladu s hodnotou na něm uvedenou.
- NEPOKLÁDEJTE na nerovné ani nestabilní pracovní povrchy. Pokud je skříň počítače poškozená, vyhledejte opravnu.
- NEDÁVEJTE ani neupouštějte předměty na horní stranu produktu ani do něj nezastřikujte žádné cizí objekty.
- NEVYSTAVUJTE ani nepoužívejte blízko tekutin, deště nebo vlhkosti. NEPOUŽÍVEJTE modem během bouřek.
- NEZAKRÝVEJTE otvory na produktu, které mají zabránit přehřátí systému.
- NEPOUŽÍVEJTE poškozené napájecí kabely, doplňky ani jiné periférie.
- Pokud je napájecí zdroj porouchaný, nepokoušejte se jej opravovat. Kontaktujte kvalifikovaného servisního technika nebo prodejce.
- Aby nedošlo k zásahu elektrickým proudem, odpojte napájecí kabel z elektrické zásuvky před přemístěním počítače.

Estonian CE statement

Lihtsustatud ELi vastavusdeklaratsioon

Käesolevaga kinnitab ASUSTek Computer Inc., et see seade on vastavuses direktiivi 2014/53/EL oluliste nõuete ja teiste asjakohaste sätetega. ELi vastavusdeklaratsiooni täielik tekst on saadaval aadressil https://www.asus.com/Networking/ROG-Rapture-GT-AXE11000/HelpDesk_Declaration/.

Vastavuse kinnitus ökodisaini direktiivile 2009/125/EÜ

Ökodisaini erinõuetele vastavust testiti kooskõlas määruste (EÜ) nr 1275/2008 ja (EÜ) nr 801/2013 nõuetega. Kui seade on võrku ühendatud ooterežiimis, on selle I/O ja võrguliides unerežiimis ning seetõttu on võimalik, et seade ei toimi nõuetekohaselt. Seadme äratamiseks vajutage Wi-Fi on/off-nuppu, LED on/off-nuppu, lähtestusnuppu või WPS nuppu.

Käesolev seade vastab kontrollimata keskkonnale sätestatud ELi kiirgusnormidele. Antud seadme paigaldamisel ja kasutamisel tuleb arvestada, et see peab jääma radiaatorist ja teie kehast vähemalt 20 cm kaugusele.

Kõik töörežiimid:

2.4GHz: 802.11b, 802.11g, 802.11n (HT20), 802.11n (HT40), 802.11ac (VHT20), 802.11ac (VHT40)

5GHz: 802.11a, 802.11n (HT20), 802.11n (HT40), 802.11ac (VHT20), 802.11ac (VHT40), 802.11ac (VHT80)

Teave sageduse, režiimi ja maksimaalse edastatava võimsuse kohta ELis on esitatud allpool:

2412-2472MHz (802.11g 6Mbps): 19.81 dBm

5180-5240MHz (802.11ac VHT20 MCS0): 20.1 dBm

5260-5320MHz (802.11ac VHT40 MCS0): 21.31 dBm

5500-5700MHz (802.11ac VHT80 MCS0): 27.48 dBm

Seadet tuleb kasutada ainult sisetingimustes sagedusvahemikus 5150 MHz kuni 5350 MHz.

Adapter tuleb paigaldada seadme lähedusse, kus see on hõlpsalt kättesaadav.

	AT	BE	BG	CZ	DK	EE	FR
	DE	IS	IE	IT	EL	ES	CY
	LV	LI	LT	LU	HU	MT	NL
	NO	PL	PT	RO	SI	SK	TR
	FI	SE	CH	HR	UK(NI)		

Safety Notices

- Seda seadet võib kasutada ümbritseva keskkonna temperatuuril 0 °C (32 °F) kuni 40 °C (104 °F).
- Vaadake seadme põhjal asuvat silti ja veenduge, et teie toiteadapter vastab toitepingele.
- ÄRGE asetage ebaühtlasele või ebastabiilsele pinnale. Kui aku ümbris on kahjustada saanud, pöörduge teenindusse.
- ÄRGE pange või laske kukkuda mingeid esemeid seadme peale ja ärge torgake midagi seadme sisse.
- ÄRGE kasutage seadet vihma käes ega vedelike ja niiskuse lähedal. ÄRGE kasutage modemit äikese ajal.
- ÄRGE katke kinni seadme õhutusavasid, et vältida selle ülekuumenemist.
- ÄRGE kasutage kahjustunud toitejuhtmeid, lisa- ega välisseadmeid.
- Kui toiteadapter on rikkis, siis ärge püüdke seda ise parandada. Võtke ühendust kvalifitseeritud hooldustehnikuga või jaemüüjaga.
- Elektrilöögi ohu vältimiseks ühendage toitekaabel pistikupesast lahti enne, kui süsteemi ümber paigutate.

Hungarian CE statement

Egyszerűsített EU-megfeleléségi nyilatkozat

Az ASUSTek Computer Inc. ezennel kijelenti, hogy ez a készülék megfelel a 2014/53/EU irányelv alapvető követelményeinek és egyéb vonatkozó rendelkezéseinek. Az EU-megfeleléségi nyilatkozat teljes szövegét a következő weboldalon tekintheti meg: https://www.asus.com/Networking/ROG-Rapture-GT-AXE11000/HelpDesk_Declaration/.

Megfeleléségi nyilatkozat a környezettudatos tervezésről szóló 2009/125/EK irányelvhez

A környezettudatos tervezés követelményeit illetően tesztelést végeztünk az (EK) 1275/2008 és (EU) 801/2013 előírásai szerint. Ha a készülék hálózati készenléti üzemmódba van állítva, akkor az I/O és a hálózati csatló alvó üzemmódba kerül, és elképzelhető, hogy nem működik megfelelően. A készülék felélesztéséhez nyomja meg a Wi-Fi vagy a LED főkapcsolóját, a reset gombot vagy a WPS gombot.

Ez a berendezés megfelel az Európai Unió rádiófrekvenciás sugárzásra vonatkozó, ellenőrizetlen környezethez megállapított határértékeinek. A készülék telepítésekor és használata során legalább 20 cm távolságot kell hagyni a fűtőtest és a teste között.

Minden működési üzemmód:

2.4GHz: 802.11b, 802.11g, 802.11n (HT20), 802.11n (HT40), 802.11ac (VHT20), 802.11ac (VHT40)

5GHz: 802.11a, 802.11n (HT20), 802.11n (HT40), 802.11ac (VHT20), 802.11ac (VHT40), 802.11ac (VHT80)

Az alábbiakban megtekintheti az Európai Unióban érvényes frekvenciát, üzemmódot és maximális átviteli teljesítményt:

2412-2472MHz (802.11g 6Mbps): 19.81 dBm

5180-5240MHz (802.11ac VHT20 MCS0): 20.1 dBm

5260-5320MHz (802.11ac VHT40 MCS0): 21.31 dBm

5500-5700MHz (802.11ac VHT80 MCS0): 27.48 dBm

Az 5150 és 5350 MHz közötti frekvenciatartományban a készülék beltéri használatra van korlátozva.

Az adaptert a berendezés közelében kell telepíteni, és egyszerűen elérhetővé kell tenni.

	AT	BE	BG	CZ	DK	EE	FR
	DE	IS	IE	IT	EL	ES	CY
	LV	LI	LT	LU	HU	MT	NL
	NO	PL	PT	RO	SI	SK	TR
	FI	SE	CH	HR	UK(NI)		

Safety Notices

- A terméket 0°C (32°F) és 40°C (104°F) közötti hőmérsékleten használja.
- Tekintse meg a termék alján lévő minősítési címkét, és ellenőrizze, hogy a hálózati adapter megfelel a minősítésnek.
- NE tegye a számítógépet labilis, vagy egyenetlen felületre. A sérült burkolatot javíttassa meg.
- NE helyezzen és NE ejtsen tárgyakat a készülék tetejére, és ne dugjon idegen tárgyakat a belsejébe.
- NE tegye ki folyadéknak, esőnek vagy nedvességnek, vagy használja azok közelében. NE használja a modemet villámlás közben.
- NE fedje be a készüléken lévő szellőzőnyílásokat, nehogy túlmelegedjen a rendszer.
- NE használjon sérült tápkábelt, kiegészítőt vagy más perifériát.
- Ha a tápegység elromlik, ne kísérelje meg saját maga megjavítani. Forduljon szakemberhez vagy a termék viszonteladójához.
- Az áramütés elkerülése érdekében húzza ki a berendezés tápkábelét a konnektorból, mielőtt áthelyezné a rendszert.

Latvian CE statement

Vienkāršots ES paziņojums par atbilstību

Ar šo ASUSTek Computer Inc. paziņo, ka šī ierīce atbilst Direktīvas Nr. 2014/53/ES būtiskām prasībām un citiem attiecīgiem noteikumiem. Pilns ES atbilstības paziņojuma teksts ir pieejams šeit: https://www.asus.com/Networking/ROG-Rapture-GT-AXE11000/HelpDesk_Declaration/.

Atbilstības paziņojums ekodizaina Direktīvai Nr. 2009/125/EK

Veikta ekodizaina prasību pārbaude saskaņā ar Komisijas Regulu (EK) Nr. 1275/2008 un Komisijas Regulu (ES) Nr. 801/2013. Ja ierīce ir tikla gaidstāves režīmā, tās I/O (ievade/izvade) un tikla interfeiss ir miega režīmā un var nedarboties pareizi. Lai aktivizētu ierīci, nospiediet pogu Wi-Fi on/off (Wi-Fi ieslēgts/izslēgts), LED on/off (LED ieslēgts/izslēgts), reset (atiestatīt) vai WPS.

Šī ierīce atbilst ES radiācijas iedarbības ierobežojumiem, kas noteikti videi, kur šī iedarbība netiek kontrolēta. Šī ierīce ir jāuzstāda un jādarbina, ievērojot minimālo attālumu 20 cm starp radiatoru un ķermeni.

Visi darbības režīmi:

2.4GHz: 802.11b, 802.11g, 802.11n (HT20), 802.11n (HT40), 802.11ac (VHT20), 802.11ac (VHT40)

5GHz: 802.11a, 802.11n (HT20), 802.11n (HT40), 802.11ac (VHT20), 802.11ac (VHT40), 802.11ac (VHT80)

Frekvence, režīms un maksimālā pārraidītā jauda ES ir norādīta tālāk.

2412-2472MHz (802.11g 6Mbps): 19.81 dBm

5180-5240MHz (802.11ac VHT20 MCS0): 20.1 dBm

5260-5320MHz (802.11ac VHT40 MCS0): 21.31 dBm

5500-5700MHz (802.11ac VHT80 MCS0): 27.48 dBm

Šī ierīce, darbojoties no 5150 MHz līdz 5350 MHz frekvences diapazonā, paredzēta tikai lietošanai iekšējās telpās.

Adapterim ir jābūt novietotam ierīces tuvumā un viegli pieejamam.

	AT	BE	BG	CZ	DK	EE	FR
	DE	IS	IE	IT	EL	ES	CY
	LV	LI	LT	LU	HU	MT	NL
	NO	PL	PT	RO	SI	SK	TR
	FI	SE	CH	HR	UK(NI)		

Safety Notices

- Lietojiet šo ierīci tikai vietās, kur apkārtējā temperatūra ir no 0°C (32°F) līdz 40°C (104°F).
- Skatiet strāvas parametru uzlīmi ierīces apakšā un pārliecinieties, lai strāvas adapteris atbilstu parametriem.
- NENOVIETOT uz nelidzenas un nestabilas darba virsmas. Vērsieties tehniskās palīdzības dienestā, ja ir bojāts ārējais ietvars.
- NENOVIETOT vai nemest priekšmetus uz virsmas un neievietot ierīcē nekādus svešķermeņus.
- NEPAKĻAUT šķidrumu, lietus vai mitruma ietekmei vai nelietot to tuvumā. NELIETOT modemu negaisa laikā.
- NEAPKLĀT ierīces ventilācijas atveres, lai sistēma nepārkarstu.
- NELIETOT bojātus strāvas vadus, papildierīces vai citas ārējās ierīces.
- Ja adapteris ir bojāts, neveiciet tā remontu pats. Sazinieties ar kvalificētu speciālistu vai savu pārdevēju.
- Lai novērstu elektriskās strāvas trieciena risku, atvienojiet strāvas kabeli no strāvas kontaktligzdas pirms sistēmas pārvietošanas.

Lituanian

CE statement

Supaprastinta ES atitikties deklaracija

Šiame dokumente bendrovė „ASUSTek Computer Inc.“ pareiškia, kad šis prietaisas atitinka pagrindinius reikalavimus ir kitas susijusias Direktyvos 2014/53/EB nuostatas. Visą ES atitikties deklaracijos tekstą rasite https://www.asus.com/Networking/ROG-Rapture-GT-AXE11000/HelpDesk_Declaration/.

Ekologinio projektavimo direktyvos 2009/125/EB atitikties deklaracija

Atliktas ekologinio projektavimo reikalavimų pagal (EB) Nr. 1275/2008 ir (ES) Nr. 801/2013 atitikimo patikrinimas. Kai prietaisas yra prijungtas prie tinklo ir veikia budėjimo režimu, jo įjungimo / išjungimo ir tinklo sąsaja veikia miego režimu ir negali tinkamai veikti. Norėdami pažadinti prietaisą, paspauskite „Wi-Fi“ įjungimo / išjungimo, šviesos diodo įjungimo / išjungimo, nustatymo iš naujo arba WPS mygtuką.

Ši įranga atitinka ES radiacijos poveikio ribas, nustatytas nekontroliuojamai aplinkai. Šį prietaisą reikia statyti ir naudoti ten, kur jis būtų bent 20 cm atstumu nuo jūsų kūno.

Visi operaciniai režimai:

2.4GHz: 802.11b, 802.11g, 802.11n (HT20), 802.11n (HT40), 802.11ac (VHT20), 802.11ac (VHT40)

5GHz: 802.11a, 802.11n (HT20), 802.11n (HT40), 802.11ac (VHT20), 802.11ac (VHT40), 802.11ac (VHT80)

Dažnis, režimas ir maksimali signalų siuntimo galia ES nurodyta toliau:

2412-2472MHz (802.11g 6Mbps): 19.81 dBm

5180-5240MHz (802.11ac VHT20 MCS0): 20.1 dBm

5260-5320MHz (802.11ac VHT40 MCS0): 21.31 dBm

5500-5700MHz (802.11ac VHT80 MCS0): 27.48 dBm

Šį įrenginį galima naudoti tik patalpoje, kai jis veikia 5150–5350 MHz dažnių diapazone.

Adapteris privalo būti įrengtas šalia įrenginio ir jis turi būti lengvai pasiekiamas.

	AT	BE	BG	CZ	DK	EE	FR
	DE	IS	IE	IT	EL	ES	CY
	LV	LI	LT	LU	HU	MT	NL
	NO	PL	PT	RO	SI	SK	TR
	FI	SE	CH	HR	UK(NI)		

Safety Notices

- Naudokitės šiuo gaminiu tik esant 0°C (32°F)–40 °C (104°F) aplinkos oro temperatūrai.
- Žr. techninių charakteristikų etiketę, esančią gaminio apačioje, ir įsitikinkite, ar maitinimo adapteris atitinka tas charakteristikas.
- NESTATYKITE ant nelygių ar nestabilių darbinų paviršių. Kreipkitės pagalbos, jei pažeidėte korpusą.
- NEDĖKITE ant viršaus, neužmeskite arba neikiškite į gaminį pašalinių daiktų.
- NENAUDOKITE drėgnoje vietoje, šalia skysčių, kur yra drėgna, neleiskite aplyti. NENAUDOKITE modemo per elektros audras.
- NEUŽDENKITE gaminio ventilacijos angų, kad sistema neperkaistų.
- NENAUDOKITE pažeistų maitinimo laidų, priedų ar kitų periferinių įrenginių.
- Jei adapteris sugestų, nebandykite jo remontuoti patys. Kreipkitės į kvalifikuotą meistrą arba pardavėją.
- Norėdami išvengti elektros smūgio pavojaus, prieš perkeldami sistemą į kitą vietą, atjunkite maitinimo kabelį nuo elektros lizdo.

Polish CE statement

Uproszczona deklaracja zgodności UE

Firma ASUSTek Computer Inc. niniejszym oświadcza, że urządzenie to jest zgodne z zasadniczymi wymogami i innymi właściwymi postanowieniami dyrektywy 2014/53/UE. Pełny tekst deklaracji zgodności UE jest dostępny pod adresem <https://www.asus.com/Networking/ROG-Rapture-GT-AXE11000/HelpDesk/Declaration/>.

Deklaracja zgodności dotycząca dyrektywy w sprawie ekoprojektu 2009/125/WE

Przeprowadzono testy pod kątem wymogów dotyczących ekoprojektu zgodnie z rozporządzeniem (WE) Nr 1275/2008 i (UE) Nr 801/2013. Gdy urządzenie jest w sieciowym trybie czuwania, jego porty We/Wy oraz interfejs sieciowy również znajdują się w trybie uśpienia i mogą nie działać prawidłowo. W celu wznowienia pracy urządzenia należy nacisnąć przycisk włączania/wyłączania sieci Wi-Fi, przycisk włączania/wyłączania wskaźnika LED, przycisk resetowania lub WPS.

To urządzenie jest zgodne z limitami UE dotyczącymi ekspozycji na promieniowanie ustanowionymi dla niekontrolowanego środowiska. Urządzenie to powinno być zainstalowane i używane przy zachowaniu minimalnej odległości 20 cm między radiatorem, a ciałem.

Wszystkie tryby działania:

2.4GHz: 802.11b, 802.11g, 802.11n (HT20), 802.11n (HT40), 802.11ac (VHT20), 802.11ac (VHT40)

5GHz: 802.11a, 802.11n (HT20), 802.11n (HT40), 802.11ac (VHT20), 802.11ac (VHT40), 802.11ac (VHT80)

Poniżej wskazano częstotliwość, tryb i maksymalną moc nadawania w UE:

2412-2472MHz (802.11g 6Mbps): 19.81 dBm

5180-5240MHz (802.11ac VHT20 MCS0): 20.1 dBm

5260-5320MHz (802.11ac VHT40 MCS0): 21.31 dBm

5500-5700MHz (802.11ac VHT80 MCS0): 27.48 dBm

Działanie tego urządzenia w zakresie częstotliwości od 5150 do 5350 MHz jest ograniczone wyłącznie do użytku wewnątrz pomieszczeń.

Ten adapter należy zainstalować w pobliżu urządzenia i powinien on być łatwo dostępny.

	AT	BE	BG	CZ	DK	EE	FR
	DE	IS	IE	IT	EL	ES	CY
	LV	LI	LT	LU	HU	MT	NL
	NO	PL	PT	RO	SI	SK	TR
	FI	SE	CH	HR	UK(NI)		

Safety Notices

- Ten produkt należy używać w miejscach o temperaturze otoczenia w zakresie 0°C (32°F) do 40°C (104°F).
- Należy sprawdzić tabliczkę znamionową na spodzie produktu i upewnić się, że zasilacz jest zgodny z podanymi wartościami.
- NIE NALEŻY umieszczać urządzenia na nierównych lub niestabilnych powierzchniach roboczych. Po uszkodzeniu obudowy należy przekazać komputer do serwisu.
- NIE NALEŻY umieszczać, upuszczać lub wpychać żadnych obcych obiektów na produkt.
- NEI NALEŻY wystawiać na działanie lub używać komputera w pobliżu płynów, na deszczu lub wilgoci. NIE NALEŻY używać modemu podczas burz z wyładowaniami elektrycznymi.
- Aby zapobiec przegrzaniu systemu NIE NALEŻY zakrywać szczelin produktu.
- NIE NALEŻY przykrywać szczelin wentylacyjnych komputera desktop PC, aby zapobiec przegrzaniu systemu.
- Jeśli uszkodzony został zasilacz nie należy próbować naprawiać go samemu. Należy skontaktować się z wykwalifikowanym technikiem serwisu lub ze sprzedawcą.
- Aby zapobiec porażeniu prądem elektrycznym, przed przeniesieniem systemu należy odłączyć kabel zasilający od gniazdka elektrycznego.

Romanian CE statement

Declarație de conformitate UE simplificată

ASUSTek Computer Inc. declară că acest dispozitiv este în conformitate cu cerințele esențiale și cu alte prevederi relevante ale Directivei 2014/53/UE. Declarația de conformitate UE completă este disponibilă la adresa: https://www.asus.com/Networking/ROG-Rapture-GT-AXE11000/HelpDesk_Declaration/.

Declarația de conformitate pentru Directiva privind proiectarea ecologică 2009/125/CE

Testarea pentru cerințele de proiectare ecologică în conformitate cu (CE) nr. 1275/2008 și (UE) nr. 801/2013 a fost efectuată. Când dispozitivul se află în modul de standby în rețea, I/E și interfața de rețea se află în modul de repaus și pot să nu funcționeze corect. Pentru a reactiva dispozitivul, apăsați butonul de pornire/oprire Wi-Fi, pornire/oprire LED, resetare sau butonul WPS.

Acest dispozitiv se încadrează în limitele de expunere la radiații UE stabilite pentru un mediu necontrolat. Acest echipament trebuie instalat și operat cu distanța minimă de 20 cm între radiator și corpul dvs.

Toate modurile de funcționare:

2.4GHz: 802.11b, 802.11g, 802.11n (HT20), 802.11n (HT40), 802.11ac (VHT20), 802.11ac (VHT40)

5GHz: 802.11a, 802.11n (HT20), 802.11n (HT40), 802.11ac (VHT20), 802.11ac (VHT40), 802.11ac (VHT80)

Frecvența, modul și puterea maximă transmisă în UE sunt enumerate mai jos:

2412-2472MHz (802.11g 6Mbps): 19.81 dBm

5180-5240MHz (802.11ac VHT20 MCS0): 20.1 dBm

5260-5320MHz (802.11ac VHT40 MCS0): 21.31 dBm

5500-5700MHz (802.11ac VHT80 MCS0): 27.48 dBm

Dispozitivul este restricționat doar la utilizarea în interior în cazul operării în intervalul de frecvență cuprins între 5.150 și 5.350 MHz.

Adaptorul trebuie montat în apropierea echipamentului și trebuie să poată fi accesat ușor.

	AT	BE	BG	CZ	DK	EE	FR
	DE	IS	IE	IT	EL	ES	CY
	LV	LI	LT	LU	HU	MT	NL
	NO	PL	PT	RO	SI	SK	TR
	FI	SE	CH	HR	UK(NI)		

Safety Notices

- Utilizați PC-ul desktop în medii cu temperatura ambiantă cuprinsă între 0 °C (32 °F) și 40 °C (104 °F).
- Consultați eticheta de pe partea de jos a produsului pentru a vă asigura că adaptorul dvs. este conform.
- NU așezați produsul pe suprafețe de lucru neregulate sau instabile. În cazul în care carcasa s-a deteriorat, solicitați operații de service.
- NU plasați și nu scăpați obiecte pe partea de sus a produsului și nu introduceți obiecte externe în produs.
- NU expuneți PC-ul desktop la lichide, la ploaie sau la umezeală. NU utilizați PC-ul desktop în timpul furtunilor cu descărcări electrice.
- NU acoperiți orificiile de ventilare de pe produs. În caz contrar, este posibil ca sistemul să se supraîncălzească.
- NU utilizați cabluri de alimentare, accesorii sau echipamente periferice deteriorate.
- Dacă sursa de alimentare se defectează, nu încercați să o reparați singur. Contactați un tehnician de service calificat sau distribuitorul local.
- Pentru a preveni pericolul de electrocutare, deconectați cablul de alimentare de la priza electrică înainte de reamplasarea sistemului.

Serbian CE statement

Pojednostavljena EU deklaracija o saglasnosti

ASUSTek Computer Inc. ovim potvrđuje da je ovaj uređaj u saglasnosti sa ključnim zahtevima i drugim relevantnim odredbama Direktive 2014/53/EU. Pun tekst EU deklaracije o saglasnosti je dostupan na adresi https://www.asus.com/Networking/ROG-Rapture-GT-AXE11000/HelpDesk_Declaration/.

Deklaracija o saglasnosti za Ekodizajn direktivu 2009/125/EC

Testiranje za eko-dizajn zahteve u skladu sa (EC) Br 1275/2008 i (EU) Br 801/2013 je obavljeno. Kada je ovaj uređaj u režimu za stanje pripravnosti mreže, njegov I/O i mrežni interfejs su u režimu za spavanje i možda neće raditi ispravno. Da probudite uređaj, pritisnite Wi-Fi da uključite/isključite, uključite/isključite LED, resetujte ili WPS pritisnite taster.

Ova oprema u saglasnosti je sa EU ograničenjima za izloženost radijaciji, određenih za nekontrolisanu sredinu. Ova oprema treba da bude instalirana i da se njome upravlja sa minimalne udaljenosti od 20 cm između radijatora i vašeg tela.

Svi radni režimi:

2.4GHz: 802.11b, 802.11g, 802.11n (HT20), 802.11n (HT40), 802.11ac (VHT20), 802.11ac (VHT40)

5GHz: 802.11a, 802.11n (HT20), 802.11n (HT40), 802.11ac (VHT20), 802.11ac (VHT40), 802.11ac (VHT80)

Frekvencija, režim i maksimalna snaga prenošenja u EU su navedeni ispod:

2412-2472MHz (802.11g 6Mbps): 19.81 dBm

5180-5240MHz (802.11ac VHT20 MCS0): 20.1 dBm

5260-5320MHz (802.11ac VHT40 MCS0): 21.31 dBm

5500-5700MHz (802.11ac VHT80 MCS0): 27.48 dBm

Uređaj je ograničen za korišćenje unutra samo kada radi u frekventnom opsegu od 5150 to 5350 MHz.

Adapter treba da bude instaliran blizu opreme i lako dostupan.

	AT	BE	BG	CZ	DK	EE	FR
	DE	IS	IE	IT	EL	ES	CY
	LV	LI	LT	LU	HU	MT	NL
	NO	PL	PT	RO	SI	SK	TR
	FI	SE	CH	HR	UK(NI)		

Safety Notices

- Koristite ovaj proizvod u sredinama sa ambijentalnom temperaturom između 0°C (32°F) and 40°C (104°F).
- Pogledajte etiketu sa oznakom na dnu svog proizvoda i proverite da se vaš adapter za napajanje slaže sa ovom oznakom.
- NE stavljajte na neravnu ili nestabilnu radnu površinu. Potražite servisiranje ukoliko je kućište oštećeno.
- NE postavljajte i ne ispuštajte predmete na vrhu i ne gurajte strane predmete u proizvod.
- NE izlažite tečnostima i ne koristite u blizini tečnosti, kiše ili vlage. NE koristite modem tokom oluja sa grmljavinom.
- NE pokrivajte otvore na proizvodu da biste sprečili da se sistem pregreje.
- NE koristite oštećene kablove za struju, dodatke ili druge periferne uređaje.
- Ukoliko se adapter polomi, ne pokušavajte da ga sami popravite. Pozovite kvalifikovanog tehničara za popravku ili svog prodavca.
- Da sprečite rizik od električnog šoka, isključite kabl za struju iz električne utičnice pre premeštanja sistema.

Slovanian CE statement

Poenostavljena izjava o skladnosti EU

ASUSTek Computer Inc. izjavlja, da je ta naprava skladna s temeljnimi zahtevami in drugimi relevantnimi določili Direktive 2014/53/EU. Celotno besedilo izjave EU o skladnosti je na voljo na spletnem mestu https://www.asus.com/Networking/ROG-Rapture-GT-AXE11000/HelpDesk_Declaration/.

Izjava o skladnosti za Direktivo o okoljsko primerni zasnovi 2009/125/ES

Testiranje glede zahtev za okoljsko primerno zasnovo v skladu z (ES) št. 1275/2008 in (EU) št. 801/2013 je bilo izvedeno. Če je naprava v omrežnem načinu pripravljenosti, sta vhodno-izhodni in omrežni vmesnik v načinu spanja in morda ne bosta delovala pravilno. Če želite napravo prebuditi, pritisnite gumb za vklop/izklop Wi-Fi, vklop/izklop LED, ponastavitev ali WPS.

Oprema je v skladu z omejitvami EU o izpostavljenosti sevanju za nenadzorovano okolje. Opremo namestite in z njo upravljajte na najmanjši oddaljenosti 20 cm med radiatorjem in telesom.

Vsi načini delovanja:

2.4GHz: 802.11b, 802.11g, 802.11n (HT20), 802.11n (HT40), 802.11ac (VHT20), 802.11ac (VHT40)

5GHz: 802.11a, 802.11n (HT20), 802.11n (HT40), 802.11ac (VHT20), 802.11ac (VHT40), 802.11ac (VHT80)

Frekvenca, način in maksimalna oddajna moč v EU so navedene v nadaljevanju:

2412-2472MHz (802.11g 6Mbps): 19.81 dBm

5180-5240MHz (802.11ac VHT20 MCS0): 20.1 dBm

5260-5320MHz (802.11ac VHT40 MCS0): 21.31 dBm

5500-5700MHz (802.11ac VHT80 MCS0): 27.48 dBm

Naprava se v notranjih prostorih lahko uporablja samo, če deluje v frekvenčnem območju od 5150 MHz do 5350 MHz.

Napajalnik morate namestiti blizu opreme, kjer je preprosto dostopen.

	AT	BE	BG	CZ	DK	EE	FR
	DE	IS	IE	IT	EL	ES	CY
	LV	LI	LT	LU	HU	MT	NL
	NO	PL	PT	RO	SI	SK	TR
	FI	SE	CH	HR	UK(NI)		

Safety Notices

- Izdelek uporabljajte v okoljih s temperaturo med 0 °C in 40 °C.
- Preberite oznake na nalepki na dnu vašega izdelka in se prepričajte, da je napajalnik skladen z zahtevami, navedenimi na nalepki.
- Naprave NE postavljajte na neravne ali nestabilne delovne površine. V primeru poškodbe ohišja poiščite pomoč servisa.
- Na napravo NE SMETE postavljati ali nanjo spuščati predmetov oz. vanjo potiskati kakršnega koli tujka.
- Naprave NE izpostavljajte oz. uporabljajte v bližini tekočin, dežja ali vlage. Modema NE SMETE uporabljati med nevihtami.
- Prezračevalnih rež na izdelku NE SMETE pokriti zato, da se sistem ne pregreje.
- NE uporabljajte poškodovanih napajalnih kablov, dodatkov ali drugih zunanjih naprav.
- Če je napajalnik poškodovan, ga ne poskušajte popraviti sami. Stopite v stik z usposobljenim servisierjem ali prodajalcem.
- Če želite preprečiti nevarnost električnega sunka, pred prestavljanjem sistema odklopite napajalni kabel iz električne vtičnice.

Slovakian CE statement

Zjednodušené vyhlásenie o zhode ES

Spoločnosť ASUSTek Computer Inc. týmto vyhlasuje, že toto zariadenie je v zhode s hlavnými požiadavkami a ostatnými príslušnými ustanoveniami smernice 2014/53/EÚ. Celý text vyhlásenia o zhode ES nájdete na adrese <https://www.asus.com/Networking/ROG-Rapture-GT-AXE11000/HelpDesk/Declaration/>.

Vyhlasenie o zhode podľa smernice o ekodizajne č. 2009/125/ES

Bolo vykonané testovanie na splnenie požiadaviek na ekodizajn podľa smernice (ES) č. 1275/2008 a (EÚ) č. 801/2013. Ak je zariadenie v pohotovostnom režime v rámci siete, jeho vstupné/výstupné a sieťové rozhranie sú v režime spánku a nemusia správne fungovať. Ak chcete zariadenie zobudiť, stlačte tlačidlo Zapnúť/Vypnúť Wi-Fi / Zapnúť/Vypnúť LED / Resetovanie alebo WPS.

Toto zariadenie vyhovuje európskym (EÚ) limitným hodnotám pre vystavenie zariadeniu stanoveným pre nekontrolované prostredie. Toto zariadenie sa má inštalovať a prevádzkovať minimálne v 20 cm vzdialenosti medzi žiaricom a telom.

Všetky prevádzkové režimy:

2.4GHz: 802.11b, 802.11g, 802.11n (HT20), 802.11n (HT40), 802.11ac (VHT20), 802.11ac (VHT40)

5GHz: 802.11a, 802.11n (HT20), 802.11n (HT40), 802.11ac (VHT20), 802.11ac (VHT40), 802.11ac (VHT80)

Frekvencia, režim a maximálny prenosový výkon v EÚ sú uvedené nižšie:

2412-2472MHz (802.11g 6Mbps): 19.81 dBm

5180-5240MHz (802.11ac VHT20 MCS0): 20.1 dBm

5260-5320MHz (802.11ac VHT40 MCS0): 21.31 dBm

5500-5700MHz (802.11ac VHT80 MCS0): 27.48 dBm

Použitie tohto zariadenia je obmedzené na používanie len v rámci frekvenčného rozsahu 5 150 až 5 350 MHz.

Vedľa zariadenia musí byť nainštalovaný adaptér, ktorý musí byť ľahko prístupný.

	AT	BE	BG	CZ	DK	EE	FR
	DE	IS	IE	IT	EL	ES	CY
	LV	LI	LT	LU	HU	MT	NL
	NO	PL	PT	RO	SI	SK	TR
	FI	SE	CH	HR	UK(NI)		

Safety Notices

- Tento výrobok používajte v prostrediach s okolitou teplotou od 0 °C (32 °F) do 40 °C (104 °F).
- Pozrite si typový štítok na spodnej strane zariadenia a uistite sa, že napájací adaptér vyhovuje tomuto menovitému výkonu.
- NEUMIESTŇUJTE na nerovné a nestabilné pracovné povrchy. V prípade poškodenia skrinky vyhľadajte pomoc servisného strediska.
- Na hornú stranu zariadenia NEUMIESTŇUJTE ani NENECHÁVAJTE žiadne predmety a nekladajte doň žiadne cudzie predmety.
- NEVYSTAVUJTE ani nepoužívajte v blízkosti kvapalín, v daždi alebo vlhkom prostredí. NEPOUŽÍVAJTE modem počas búrky s výskytom bleskov.
- Vetracie otvory na zariadení NEZAKRÝVAJTE, aby sa neprehrievalo.
- NEPOUŽÍVAJTE káble, príslušenstvo alebo periférne zariadenia, ktoré sú poškodené.
- Keď je zdroj napájania poškodený, nepokúšajte sa ho sami opravovať. Obráťte sa na kompetentného servisného technika alebo svojho predajcu.
- Pred premiestňovaním zariadenia odpojte sieťový kábel z elektrickej zásuvky, aby sa zabránilo riziku úrazu elektrickým prúdom.

Turkish

CE statement

Basitleştirilmiş AB Uygunluk Bildirimi

ASUSTek Computer Inc., bu aygıtın temel gereksinimlerle ve 2014/53/EU Yönergesinin diğer ilgili koşullarıyla uyumlu olduğunu bildirir. AB uygunluk bildirimini tam metni https://www.asus.com/Networking/ROG-Rapture-GT-AXE11000/HelpDesk_Declaration/ adresinde bulunabilir.

2009/125/EC Çevreye Duyarlı Tasarım yönergesi için Uygunluk Bildirimi

(EC) No 1275/2008 ve (EU) No 801/2013 uyarınca çevreye duyarlı tasarım gereksinimlerine yönelik test işlemi gerçekleştirilmiştir. Aygıt Ağa Bağlı Bekleme Modundayken, G/Ç ve ağ arabirimi uyku modundadır ve uygun biçimde çalışmayabilir. Aygıtı uyku durumundan çıkarmak için Wi-Fi açık/kapalı, LED açık/kapalı, sıfırla veya WPS düğmesine basın.

Bu donanım, kontrolsüz bir ortam için belirlenen AB radyasyona maruz kalma sınırlarıyla uyumludur. Bu donanım, sinyal vericisi ve vücudunuz arasında en az 20 cm mesafe olacak şekilde yerleştirilmeli ve çalıştırılmalıdır.

Tüm işletim modları:

2.4GHz: 802.11b, 802.11g, 802.11n (HT20), 802.11n (HT40), 802.11ac (VHT20), 802.11ac (VHT40)

5GHz: 802.11a, 802.11n (HT20), 802.11n (HT40), 802.11ac (VHT20), 802.11ac (VHT40), 802.11ac (VHT80)

AB içinde frekans, mod ve iletilen en fazla güç aşağıda listelenmektedir:

2412-2472MHz (802.11g 6Mbps): 19.81 dBm

5180-5240MHz (802.11ac VHT20 MCS0): 20.1 dBm

5260-5320MHz (802.11ac VHT40 MCS0): 21.31 dBm

5500-5700MHz (802.11ac VHT80 MCS0): 27.48 dBm

5150 - 5350 MHz frekans aralığında çalıştırılırken aygıtın kullanımı yalnızca iç mekânla sınırlıdır.

Adaptör, donanımın yakınına kurulmalı ve kolayca erişilebilir olmalıdır.

	AT	BE	BG	CZ	DK	EE	FR
	DE	IS	IE	IT	EL	ES	CY
	LV	LI	LT	LU	HU	MT	NL
	NO	PL	PT	RO	SI	SK	TR
	FI	SE	CH	HR	UK(NI)		

Safety Notices

- Bu ürünü ortam sıcaklığı 0°C (32°F) ve 35°C (95°F) arasındaki sıcaklıklarda kullanın.
- Ürününüzün altındaki derecelendirme etiketine başvurun ve güç adaptörünüzün bununla uyumlu olduğundan emin olun.
- Düzgün veya sabit olmayan çalışma yüzeylerine YERLEŞTİRMEYİN. Kasa hasar görmüşse servise başvurun.
- Ürünün üzerine nesnelere koymayın veya düşürmeyin ve içine yabancı nesnelere itmeyin.
- Sıvılara, yağmura ya da neme maruz BIRAKMAYIN veya bunların yanında KULLANMAYIN. Şimşekli fırtınalarda modemi KULLANMAYIN.
- Sistemin aşırı ısınmasını önlemek için üründeki havalandırma deliklerinin üzerini kapatmayın.
- Sistemin aşırı ısınmasını önlemek için masaüstü PC'nin üzerindeki hava deliklerini KAPATMAYIN.
- Güç kaynağı bozulmuşsa, tek başınıza onarmaya çalışmayın. Yetkili servis teknisyeniyle veya satıcınızla bağlantı kurun.
- Elektrik çarpması riskini önlemek için, sistemin yerini değiştirmeden önce güç kablosunun elektrik prizi ile olan bağlantısını kesin.

Danish

CE statement

Forenklet EU-overensstemmelseserklæringen

ASUSTek Computer Inc. erklærer herved, at denne enhed er i overensstemmelse med hovedkravene og øvrige relevante bestemmelser i direktiv 2014/53/EU. Hele EU-overensstemmelseserklæringen kan findes på https://www.asus.com/Networking/ROG-Rapture-GT-AXE11000/HelpDesk_Declaration/.

Overensstemmelseserklæring for miljøvenligt design i direktiv 2009/125/EC

Vedrørende testkrav af øko-design i henhold til (EC) nr. 1275/2008 og (EU) nr. 801/2013 er blevet gennemført. Når enheden er på netværk-standby, er dens I/O og netværksgrænseflade i dvale, og vil muligvis ikke virke ordentligt. For at aktivere enheden, skal du trykke på trådløs til/fra, LED til/fra, nulstil eller WPS-knappen.

Dette udstyr er i overensstemmelse med EU's grænser, der er gældende i et ukontrolleret miljø. Dette udstyr skal installeres og bruges mindst 20 cm mellem radiatoren og din krop.

Alle driftsfunktioner:

2.4GHz: 802.11b, 802.11g, 802.11n (HT20), 802.11n (HT40), 802.11ac (VHT20), 802.11ac (VHT40)

5GHz: 802.11a, 802.11n (HT20), 802.11n (HT40), 802.11ac (VHT20), 802.11ac (VHT40), 802.11ac (VHT80)

Frekvensen, indstillingen og den maksimale overførte effekt i EU er anført på listen nedenfor:

2412-2472MHz (802.11g 6Mbps): 19.81 dBm

5180-5240MHz (802.11ac VHT20 MCS0): 20.1 dBm

5260-5320MHz (802.11ac VHT40 MCS0): 21.31 dBm

5500-5700MHz (802.11ac VHT80 MCS0): 27.48 dBm

Denne enhed er begrænset til indendørs brug, hvis den bruges på frekvensområdet 5150-5350 MHz.

Adapteren skal bruges i nærheden af udstyret, og skal være let tilgængelig.

	AT	BE	BG	CZ	DK	EE	FR
	DE	IS	IE	IT	EL	ES	CY
	LV	LI	LT	LU	HU	MT	NL
	NO	PL	PT	RO	SI	SK	TR
	FI	SE	CH	HR	UK(NI)		

Safety Notices

- Anvend produktet i omgivelser med temperaturer på mellem 0°C(32°F) og 40°C(104°F).
- Sørg for, at din strømadapter passer til strømoplysninger, der findes på bunden af dit produkt.
- Anbring IKKE på ujævne eller ustabile arbejdsoverflader. Send til reparation, hvis kabinettet er blevet beskadiget.
- Der må IKKE placeres eller tabes genstande på produktet. Og der må IKKE stikkes fremmedlegemer ind i produktet.
- Udsæt og brug den IKKE i nærheden af væsker, regn eller fugt. Brug IKKE modemmet under uvejr.
- Tildæk IKKE ventilationshullerne på produktet, da system ellers kan overophede.
- Brug IKKE beskadigede el-ledninger, perifere enheder og beskadiget tilbehør.
- Hvis strømforsyningen går i stykker, må du ikke prøve på selv at reparere den. Kontakt en autoriseret servicetekniker eller forhandleren.
- For at undgå faren for elektrisk stød, skal du fjerne netledningen fra stikkontakten, inden du flytter systemet til et andet sted.

Dutch CE statement

Vereenvoudigde EU-conformiteitsverklaring

ASUSTek Computer Inc. verklaart dat dit apparaat in overeenstemming is met de essentiële vereisten en andere relevante bepalingen van Richtlijn 2014/53/EU. Volledige tekst EU-conformiteitsverklaring is beschikbaar op https://www.asus.com/Networking/ROG-Rapture-GT-AXE11000/HelpDesk_Declaration/.

Conformiteitsverklaring voor Ecodesign Richtlijn 2009/125/EG

Testen van vereisten van ecodesign overeenkomstig (EG) nr. 1275/2008 en (EU) nr. 801/2013 zijn uitgevoerd. Wanneer het apparaat in de modus Stand-by in netwerk staat, staan de I/O en netwerkinterface in de slaapstand en werken wellicht niet goed. Om het apparaat uit de slaapstand te halen, drukt u op de knop Wi-Fi aan/uit, LED aan/uit, reset of WPS.

Deze apparatuur voldoet aan EU-limieten voor blootstelling aan straling als uiteengezet voor een onbeheerste omgeving. Deze apparatuur moet worden geïnstalleerd en bediend met een minimumafstand van 20 cm tussen de radiator en uw lichaam.

Alle bedrijfsmodi:

2.4GHz: 802.11b, 802.11g, 802.11n (HT20), 802.11n (HT40), 802.11ac (VHT20), 802.11ac (VHT40)

5GHz: 802.11a, 802.11n (HT20), 802.11n (HT40), 802.11ac (VHT20), 802.11ac (VHT40), 802.11ac (VHT80)

De frequentie, modus en het afgegeven maximumvermogen in de EU wordt hieronder vermeld:

2412-2472MHz (802.11g 6Mbps): 19.81 dBm

5180-5240MHz (802.11ac VHT20 MCS0): 20.1 dBm

5260-5320MHz (802.11ac VHT40 MCS0): 21.31 dBm

5500-5700MHz (802.11ac VHT80 MCS0): 27.48 dBm

Het apparaat is beperkt tot alleen binnengebruik bij werking in het frequentiebereik van 5150 tot 5350 MHz.

De adapter moet zich in de buurt van het apparaat bevinden en moet gemakkelijk toegankelijk zijn.

	AT	BE	BG	CZ	DK	EE	FR
	DE	IS	IE	IT	EL	ES	CY
	LV	LI	LT	LU	HU	MT	NL
	NO	PL	PT	RO	SI	SK	TR
	FI	SE	CH	HR	UK(NI)		

Safety Notices

- Gebruik dit product in omgevingen met omgevingstemperaturen tussen 0°C (32°F) en 40°C (104°F).
- Raadpleeg het typeplaatje op de onderkant van uw product en controleer of uw voedingsadapter voldoet aan dit type.
- NIET op onegale of instabiele werkoppervlakken plaatsen. Als de behuizing beschadigd is geraakt, dient u hulp bij onderhoud hulp te zoeken.
- Plaats of laat GEEN objecten vallen bovenop het product en schuif geen vreemde objecten in het product.
- NIET in de buurt van vloeistoffen, regen of vocht blootstellen of gebruiken. NIET de modem tijdens onweer gebruiken.
- Dek de uitlaatopeningen van het product NIET AF zodat het systeem niet oververhit raakt.
- NIET de ventilatieopeningen van de Desktop PC afdekken, om oververhitting van het systeem te voorkomen.
- Als de netvoeding is beschadigd, mag u niet proberen het zelf te repareren. Neem contact op met een bevoegde servicemonteur of uw handelaar.
- Verwijder, voordat u het systeem verplaatst, de stroomkabel uit de contactdoos om elektrische schok te vermijden.

French

CE statement

Déclaration simplifiée de conformité de l'UE

ASUSTek Computer Inc. déclare par la présente que cet appareil est conforme aux critères essentiels et autres clauses pertinentes de la directive 2014/53/UE. La déclaration de conformité de l'UE peut être téléchargée à partir du site internet suivant: https://www.asus.com/Networking/ROG-Rapture-GT-AXE11000/HelpDesk_Declaration/.

Déclaration de conformité (Directive sur l'écoconception 2009/125/CE)

Test de la conformité aux exigences d'écoconception selon [CE 1275/2008] et [UE 801/2013]. Lorsque l'appareil est en mode Networked Standby, son panneau d'E/S et son interface réseau sont en mode veille et peuvent ne pas fonctionner correctement. Pour sortir l'appareil du mode veille, appuyez sur le bouton Wi-Fi, LED, de réinitialisation ou WPS.

Cet appareil a été testé et s'est avéré conforme aux limites établies par l'UE en terme d'exposition aux radiations dans un environnement non contrôlé. Cet équipement doit être installé et utilisé avec un minimum de 20 cm de distance entre la source de rayonnement et votre corps.

Tous les modes de fonctionnement:

2.4GHz: 802.11b, 802.11g, 802.11n (HT20), 802.11n (HT40), 802.11ac (VHT20), 802.11ac (VHT40)

5GHz: 802.11a, 802.11n (HT20), 802.11n (HT40), 802.11ac (VHT20), 802.11ac (VHT40), 802.11ac (VHT80)

La fréquence, le mode et la puissance maximale transmise de l'UE sont listés ci-dessous:

2412-2472MHz (802.11g 6Mbps): 19.81 dBm

5180-5240MHz (802.11ac VHT20 MCS0): 20.1 dBm

5260-5320MHz (802.11ac VHT40 MCS0): 21.31 dBm

5500-5700MHz (802.11ac VHT80 MCS0): 27.48 dBm

Cet appareil est restreint à une utilisation en intérieur lors d'un fonctionnement dans la plage de fréquence de 5150 à 5350 MHz.

L'adaptateur doit être installé à proximité de l'équipement et être aisément accessible.

	AT	BE	BG	CZ	DK	EE	FR
	DE	IS	IE	IT	EL	ES	CY
	LV	LI	LT	LU	HU	MT	NL
	NO	PL	PT	RO	SI	SK	TR
	FI	SE	CH	HR	UK(NI)		

Safety Notices

- Utilisez ce produit dans un environnement dont la température ambiante est comprise entre 0°C (32°F) et 40°C (104°F).
- Référez-vous à l'étiquette située au dessous du produit pour vérifier que l'adaptateur secteur répond aux exigences de tension.
- NE PAS placer sur une surface irrégulière ou instable. Contactez le service après-vente si le châssis a été endommagé.
- NE PAS placer, faire tomber ou insérer d'objets sur/dans le produit.
- NE PAS exposer l'appareil à la pluie ou à l'humidité, tenez-le à distance des liquides. NE PAS utiliser le modem lors d'un orage.
- NE PAS bloquer les ouvertures destinées à la ventilation du système pour éviter que celui-ci ne surchauffe.
- NE PAS utiliser de cordons d'alimentation, d'accessoires ou autres périphériques endommagés.
- Si l'adaptateur est endommagé, n'essayez pas de le réparer vous-même. Contactez un technicien électrique qualifié ou votre revendeur.
- Pour éviter tout risque de choc électrique, débranchez le câble d'alimentation de la prise électrique avant de toucher au système.

Finnish CE statement

Yksinkertaistettu EU-vaatimustenmukaisuusvakuutus

ASUSTek Computer Inc. vakuuttaa täten, että tämä laite on 2014/53/EU-direktiivin olennaisten vaatimusten ja muiden asiaan kuuluvien lisäysten mukainen. Koko EU-vaatimustenmukaisuusvakuutuksen teksti on nähtävissä osoitteessa https://www.asus.com/Networking/ROG-Rapture-GT-AXE11000/HelpDesk_Declaration/.

Ekologisen suunnittelun direktiivin 2009/125/EY-vaatimustenmukaisuusvakuutus

Testaus (EY) N:o 1275/2008:n ja (EU) N:o 801/2013:n mukaisista ekologisista suunnitteluvaatimuksista on suoritettu. Kun laite on verkossa valmiustilassa, sen I/O- ja verkkoliittymä ovat lepotilassa eivätkä ne ehkä toimi oikein. Herättääksesi laitteen, paina Wi-Fi päälle/pois -, LED päälle/pois -, nollaa- tai WPS-painiketta.

Tämä laite täyttää EU-säteilyrajoitukset, jotka on asetettu hallitsemattomaan ympäristöön. Tämä laitteisto tulee asentaa ja sitä tulee käyttää siten, että säteilijän ja kehosi välinen etäisyys on vähintään 20 cm.

Kaikki käyttötilat:

2.4GHz: 802.11b, 802.11g, 802.11n (HT20), 802.11n (HT40), 802.11ac (VHT20), 802.11ac (VHT40)

5GHz: 802.11a, 802.11n (HT20), 802.11n (HT40), 802.11ac (VHT20), 802.11ac (VHT40), 802.11ac (VHT80)

Taajuus, tila maksimi lähetetty teho EU:ssa on listattu alla:

2412-2472MHz (802.11g 6Mbps): 19.81 dBm

5180-5240MHz (802.11ac VHT20 MCS0): 20.1 dBm

5260-5320MHz (802.11ac VHT40 MCS0): 21.31 dBm

5500-5700MHz (802.11ac VHT80 MCS0): 27.48 dBm

Tämän laitteen käyttö on rajoitettu sisätiloihin 5 150 - 5 350 MHz-in-taajuusalueella.

Verkkolaite tulee liittää lähelle laitetta helposti tavoitettavissa olevaan paikkaan.

	AT	BE	BG	CZ	DK	EE	FR
	DE	IS	IE	IT	EL	ES	CY
	LV	LI	LT	LU	HU	MT	NL
	NO	PL	PT	RO	SI	SK	TR
	FI	SE	CH	HR	UK(NI)		

Safety Notices

- Käytä tätä tuotetta ympäristöissä, joissa ympäristölämpötila on välillä 0°C (32°F) ja 40°C (104°F).
- Varmista tuotteen pohjassa sijaitsevasta arvokilvestä vastaako verkkolaite tätä nimellisarvoa.
- ÄLÄ aseta epätasaisille tai epävakailla pinnoilla. Ota yhteys huoltoon, jos kotelo on vahingoittunut.
- ÄLÄ aseta tai pudota esineitä laitteen päälle äläkä anna minkään vieraiden esineiden joutua tuotteen sisään.
- ÄLÄ altista nesteille, sateelle tai kosteudelle tai käytä niiden lähellä. ÄLÄ käytä modeemia ukkosmyrskyn aikana.
- ÄLÄ peitä tuotteen tuuletusaukkoja estääksesi tuotteen ylikuumentumisen.
- ÄLÄ käytä vahingoittuneita virtajohtoja, lisävarusteita tai muita ohjelaitteita.
- Jos virtalähde on rikkoutunut, älä itse yritä sitä korjata. Ota yhteys ammattimaiseen huoltohenkilöön tai jälleenmyyjäsi.
- Estääksesi sähköiskun vaaran irrota virtakaapeli pistorasiasta ennen järjestelmän paikan muuttamista.

German CE statement

Vereinfachte EU-Konformitätserklärung

ASUSTeK Computer Inc. erklärt hiermit, dass dieses Gerät mit den grundlegenden Anforderungen und anderen relevanten Bestimmungen der Richtlinie 2014/53/EU übereinstimmt. Der gesamte Text der EU-Konformitätserklärung ist verfügbar unter: https://www.asus.com/Networking/ROG-Rapture-GT-AXE11000/HelpDesk_Declaration/.

Konformitätserklärung für Ökodesign-Richtlinie 2009/125/EC

Die Überprüfung der Ökodesign-Anforderungen nach (EC) Nr. 1275/2008 und (EU) Nr. 801/2013 wurde durchgeführt. Wenn sich das Gerät im Netzwerkbereitschaftsmodus befindet, werden die E/A- und Netzwerkschnittstellen in den Ruhezustand versetzt und arbeiten nicht wie gewöhnlich. Um das Gerät aufzuwecken, drücken Sie die WLAN Ein/Aus-, LED Ein/Aus-, Reset- oder WPS-Taste.

Dieses Gerät erfüllt die EU-Strahlenbelastungsgrenzwerte, die für ein unbeaufsichtigtes Umfeld festgelegt wurden. Dieses Gerät sollte mit einem Mindestabstand von 20 cm zwischen der Strahlungsquelle und Ihrem Körper installiert und betrieben werden.

Alle Betriebsarten:

2.4GHz: 802.11b, 802.11g, 802.11n (HT20), 802.11n (HT40), 802.11ac (VHT20), 802.11ac (VHT40)

5GHz: 802.11a, 802.11n (HT20), 802.11n (HT40), 802.11ac (VHT20), 802.11ac (VHT40), 802.11ac (VHT80)

Die Frequenz, der Modus und die maximale Sendeleistung in der EU sind nachfolgend aufgeführt:

2412-2472MHz (802.11g 6Mbps): 19.81 dBm

5180-5240MHz (802.11ac VHT20 MCS0): 20.1 dBm

5260-5320MHz (802.11ac VHT40 MCS0): 21.31 dBm

5500-5700MHz (802.11ac VHT80 MCS0): 27.48 dBm

Das Gerät ist auf den Innenbereich beschränkt, wenn es im Frequenzbereich von 5150 MHz bis 5350 MHz betrieben wird.

Das Netzteil muss sich in der Nähe des Geräts befinden und leicht zugänglich sein.



AT	BE	BG	CZ	DK	EE	FR
DE	IS	IE	IT	EL	ES	CY
LV	LI	LT	LU	HU	MT	NL
NO	PL	PT	RO	SI	SK	TR
FI	SE	CH	HR	UK(NI)		

Safety Notices

- Benutzen Sie das Gerät nur in Umgebungen, die eine Temperatur von 0 °C (32 °F) bis 40 °C (104 °F) aufweisen.
- Prüfen Sie am Aufkleber an der Geräteunterseite, ob Ihr Netzteil den Stromversorgungsanforderungen entspricht.
- Stellen Sie das Gerät NICHT auf schräge oder instabile Arbeitsflächen. Wenden Sie sich an das Wartungspersonal, wenn das Gehäuse beschädigt wurde.
- Legen Sie KEINE Gegenstände auf das Gerät, lassen Sie keine Gegenstände darauf fallen und schieben Sie keine Fremdkörper in das Gerät.
- Setzen Sie das Gerät KEINESFALLS Flüssigkeiten, Regen oder Feuchtigkeit aus, verwenden Sie es nicht in der Nähe derartiger Gefahrenquellen. Verwenden Sie das Modem nicht während eines Gewitters.
- Decken Sie die Lüftungsöffnungen am Gerät NICHT ab, um eine Überhitzung des Systems zu vermeiden.
- Benutzen Sie KEINE beschädigten Netzkabel, Zubehörteile oder sonstigen Peripheriegeräte.
- Falls das Netzteil defekt ist, versuchen Sie nicht, es selbst zu reparieren. Wenden Sie sich an den qualifizierten Kundendienst oder Ihre Verkaufsstelle.
- Um die Gefahr eines Stromschlags zu verhindern, ziehen Sie das Netzkabel aus der Steckdose, bevor Sie das System an einem anderen Ort aufstellen.

Απλουστευμένη δήλωση συμμόρφωσης της ΕΕ

Με το παρόν, η ASUSTek Computer Inc. δηλώνει πως αυτή η συσκευή συμμορφώνεται με τις θεμελιώδεις απαιτήσεις και άλλες σχετικές διατάξεις της Οδηγίας 2014/53/ΕΕ. Το πλήρες κείμενο της δήλωσης συμμόρφωσης της ΕΕ είναι διαθέσιμο στη διεύθυνση https://www.asus.com/Networking/ROG-Rapture-GT-AXE11000/HelpDesk_Declaration/.

Δήλωση συμμόρφωσης για την οδηγία Ecodesign (Οικολογικός σχεδιασμός) 2009/125/ΕΚ

Έχει διενεργηθεί δοκιμή για τις απαιτήσεις οικολογικού σχεδιασμού σύμφωνα με τους κανονισμούς (ΕΚ) αριθ. 1275/2008 και (ΕΕ) αριθ. 801/2013. Όταν η συσκευή βρίσκεται σε λειτουργία Αναμονή δικτύου, η διασύνδεση I/O και δικτύου βρίσκονται σε κατάσταση αναμονής και ενδέχεται να μην λειτουργούν σωστά. Για να ενεργοποιήσετε τη συσκευή, πατήστε το πλήκτρο ενεργοποίησης/απενεργοποίησης Wi-Fi, ενεργοποίησης/απενεργοποίησης λυχνίας LED, επαναφοράς ή το πλήκτρο WPS.

Ο παρόν εξοπλισμός συμμορφώνεται με τα όρια έκθεσης σε ακτινοβολία της ΕΕ που έχουν διατυπωθεί για μη ελεγχόμενο περιβάλλον. Ο συγκεκριμένος εξοπλισμός πρέπει να εγκατασταθεί και να λειτουργεί με ελάχιστη απόσταση 20 εκ μεταξύ της συσκευής ακτινοβολίας και του σώματός σας.

Όλοι οι τρόποι λειτουργίας:

2.4GHz: 802.11b, 802.11g, 802.11n (HT20), 802.11n (HT40), 802.11ac (VHT20), 802.11ac (VHT40)

5GHz: 802.11a, 802.11n (HT20), 802.11n (HT40), 802.11ac (VHT20), 802.11ac (VHT40), 802.11ac (VHT80)

Η συχνότητα, ο τρόπος λειτουργίας και η μέγιστη μεταδιδόμενη ισχύς στην ΕΕ αναφέρονται παρακάτω:

2412-2472MHz (802.11g 6Mbps): 19.81 dBm

5180-5240MHz (802.11ac VHT20 MCS0): 20.1 dBm

5260-5320MHz (802.11ac VHT40 MCS0): 21.31 dBm

5500-5700MHz (802.11ac VHT80 MCS0): 27.48 dBm

Η συσκευή περιορίζεται σε χρήση σε εσωτερικούς χώρους όταν λειτουργεί στη ζώνη συχνότητας 5150 έως 5350 MHz.

Η προσαρμογέα θα πρέπει να εγκατασταθεί κοντά στον εξοπλισμό και να είναι εύκολα προσβάσιμος.

	AT	BE	BG	CZ	DK	EE	FR
	DE	IS	IE	IT	EL	ES	CY
	LV	LI	LT	LU	HU	MT	NL
	NO	PL	PT	RO	SI	SK	TR
	FI	SE	CH	HR	UK(NI)		

Safety Notices

- Να χρησιμοποιείτε το προϊόν σε χώρους με θερμοκρασίες περιβάλλοντος από 0°C έως 40°C.
- Ανατρέξτε στην ετικέτα χαρακτηριστικών στο κάτω μέρος του προϊόντος σας και βεβαιωθείτε ότι ο προσαρμογέας τροφοδοσίας σας συμμορφώνεται με την αναγραφόμενη τιμή.
- ΜΗΝ τοποθετείτε τη συσκευή σε ανώμαλη ή ασταθή επιφάνεια εργασίας. Πηγαίστε τη συσκευή για σέρβις αν το περίβλημα έχει πάθει βλάβη.
- ΜΗΝ τοποθετείτε αντικείμενα επάνω και μην σπρώχνετε αντικείμενα μέσα στο προϊόν.
- ΜΗΝ την εκθέσετε ή τη χρησιμοποιείτε κοντά σε υγρά, βροχή, ή υγρασία. ΜΗΝ χρησιμοποιείτε το μόντεμ κατά τη διάρκεια ηλεκτρικής καταιγίδας.
- ΜΗΝ καλύπτετε τα ανοίγματα εξαερισμού στο προϊόν για να αποφύγετε τυχόν υπερθέρμανση του συστήματος.
- ΜΗΝ καλύπτετε τα ανοίγματα εξαερισμού στο Desktop PC για να αποφύγετε τυχόν υπερθέρμανση του συστήματος.
- Αν το καλώδιο παροχής ρεύματος πάθει βλάβη, μην προσπαθήσετε να το επιδιορθώσετε μόνοι σας. Επικοινωνήστε με κατάλληλα εκπαιδευμένο τεχνικό επισκευών ή με τον μεταπωλητή σας.
- Για να αποφύγετε τον κίνδυνο ηλεκτροπληξίας, αποσυνδέστε το καλώδιο παροχής ρεύματος από την πρίζα πριν αλλάξετε θέση στο σύστημα.

Italian

CE statement

Dichiarazione di conformità UE semplificata

ASUSTek Computer Inc. con la presente dichiara che questo dispositivo è conforme ai requisiti essenziali e alle altre disposizioni pertinenti con la direttiva 2014/53/EU. Il testo completo della dichiarazione di conformità UE è disponibile all'indirizzo https://www.asus.com/Networking/ROG-Rapture-GT-AXE11000/HelpDesk_Declaration/.

Dichiarazione di conformità con la direttiva Ecodesign 2009/125/EC

I test per i requisiti eco-design (EC) N. 1275/2008 e (EU) N. 801/2013 sono stati eseguiti. Quando il dispositivo si trova nella modalità Standby di rete le sue interfacce di rete e I/O sono in sospensione e potrebbero non funzionare correttamente. Per riattivare il dispositivo premete uno tra i pulsanti Wi-Fi on/off, LED on/off, reset o WPS.

Questo apparecchio è conforme ai limiti UE, per l'esposizione a radiazioni, stabiliti per un ambiente non controllato. Questo apparecchio deve essere installato e utilizzato ad una distanza di almeno 20 cm dal corpo.

Tutte le modalità operative:

2.4GHz: 802.11b, 802.11g, 802.11n (HT20), 802.11n (HT40), 802.11ac (VHT20), 802.11ac (VHT40)

5GHz: 802.11a, 802.11n (HT20), 802.11n (HT40), 802.11ac (VHT20), 802.11ac (VHT40), 802.11ac (VHT80)

I valori di frequenza, modalità e massima potenza di trasmissione per l'UE sono elencati di seguito:

2412-2472MHz (802.11g 6Mbps): 19.81 dBm

5180-5240MHz (802.11ac VHT20 MCS0): 20.1 dBm

5260-5320MHz (802.11ac VHT40 MCS0): 21.31 dBm

5500-5700MHz (802.11ac VHT80 MCS0): 27.48 dBm

L'utilizzo di questo dispositivo è limitato agli ambienti interni quando si sta utilizzando la banda di frequenze compresa tra i 5150 e i 5350 MHz.

L'adattatore deve essere installato vicino al dispositivo e facilmente accessibile.

	AT	BE	BG	CZ	DK	EE	FR
	DE	IS	IE	IT	EL	ES	CY
	LV	LI	LT	LU	HU	MT	NL
	NO	PL	PT	RO	SI	SK	TR
	FI	SE	CH	HR	UK(NI)		

Safety Notices

- Usa questo prodotto in ambienti la cui temperatura sia compresa tra 0°C(32°F) e 40°C(104°F).
- Consulta l'etichetta indicante la potenza posta sul fondo del prodotto e assicurati che l'adattatore di alimentazione sia compatibile con tali valori.
- Non collocare il dispositivo su superfici irregolari o instabili. Contatta il servizio clienti se lo chassis è stato danneggiato.
- NON riporre oggetti sopra il dispositivo e non infilare alcun oggetto all'interno del dispositivo.
- NON esporre a liquidi, pioggia o umidità. NON usare il modem durante i temporali.
- NON coprire le prese d'aria del prodotto per evitare che il sistema si surriscaldi.
- NON utilizzare cavi di alimentazione, accessori o periferiche danneggiate.
- Se l'adattatore è danneggiato non provare a ripararlo. Contatta un tecnico qualificato o il rivenditore.
- Per prevenire il rischio di scosse elettriche scollega il cavo di alimentazione dalla presa di corrente prima di spostare il sistema.

Norwegian CE statement

Forenklet EU-samsvarserklæring

ASUSTek Computer Inc. erklærer herved at denne enheten er i samsvar med hovedsaklige krav og andre relevante forskrifter i direktivet 2014/53/EU. Fullstendig tekst for EU-samsvarserklæringen finnes på https://www.asus.com/Networking/ROG-Rapture-GT-AXE11000/HelpDesk_Declaration/.

Samsvarserklæring for direktiv om miljøvennlig design 2009/125/EF

Testing for miljøutfordringskrav i henhold til (EF) nr. 1275/2008 og (EU) nr. 801/2013 er utført. Når enheten er i nettverksventemodus, er I/O- og nettverksgrensesnittet i hvilemodus og fungerer kanskje ikke som det skal. Trykk Wi-Fi på/av-, LED på/av-, tilbakestill- eller WPS-knappen for å vekke enheten.

Dette utstyret samsvarer med FCC-grensene for strålingseksponering for et ukontrollert miljø. Dette utstyret bør installeres og brukes med en minimumsavstand på 20 cm mellom radiatoren og kroppen din.

Alle operasjonsmoduser:

2.4GHz: 802.11b, 802.11g, 802.11n (HT20), 802.11n (HT40), 802.11ac (VHT20), 802.11ac (VHT40)

5GHz: 802.11a, 802.11n (HT20), 802.11n (HT40), 802.11ac (VHT20), 802.11ac (VHT40), 802.11ac (VHT80)

Frekvens, modus og maksimal overføringskraft i EU er oppført nedenfor:

2412-2472MHz (802.11g 6Mbps): 19.81 dBm

5180-5240MHz (802.11ac VHT20 MCS0): 20.1 dBm

5260-5320MHz (802.11ac VHT40 MCS0): 21.31 dBm

5500-5700MHz (802.11ac VHT80 MCS0): 27.48 dBm

Enheten er begrenset til innendørs bruk når den brukes i frekvensområdet 5150 til 5350 MHz.

Adapteren skal plasseres nært utstyret og være lett tilgjengelig.

	AT	BE	BG	CZ	DK	EE	FR
	DE	IS	IE	IT	EL	ES	CY
	LV	LI	LT	LU	HU	MT	NL
	NO	PL	PT	RO	SI	SK	TR
	FI	SE	CH	HR	UK(NI)		

Safety Notices

- Bruk dette produktet i miljø med en romtemperatur mellom 0°C(32°F) og 40°C(104°F).
- Se etiketten på undersiden av produktet, og sørg for strømforsyningen er i samsvar med denne klassifiseringen.
- Må IKKE plasseres på ujevne eller ustabile overflater. Oppsøk service dersom kassen har blitt skadet.
- IKKE plasser eller slipp gjenstander på, eller skyv gjenstander inn i, produktet.
- Må IKKE eksponeres for eller brukes i nærheten av væsker, regn eller fuktighet. Modemet skal IKKE brukes under elektrisk storm.
- IKKE dekk til ventilene på produktet for å forhindre at systemet blir for varmt.
- Skadede strømledninger, tilleggsutstyr eller annet periferiutstyr skal IKKE brukes.
- Hvis strømforsyningen er ødelagt, må du ikke prøve å reparere det selv. Kontakt en kvalifisert servicetekniker eller forhandleren.
- For å forhindre elektrisk sjokk, koble strømkabelen fra det elektriske taktet før du flytter systemet.

Portuguese

CE statement

Declaração de conformidade simplificada da UE

A ASUSTek Computer Inc. declara que este dispositivo está em conformidade com os requisitos essenciais e outras disposições relevantes da Diretiva 2014/53/CE. O texto integral da declaração de conformidade da UE está disponível em <https://www.asus.com/Networking/ROG-Rapture-GT-AXE11000/HelpDesk/Declaration/>.

Declaração de conformidade para a Diretiva Conceção Ecológica 2009/125/CE

Foram realizados testes de requisitos de conceção ecológica de acordo com o N° 1275/2008 (CE) e N° 801/2013 (UE). Quando o dispositivo se encontra no modo de espera em rede, a interface de E/S e de rede encontram-se no modo de suspensão e poderão não funcionar corretamente. Para ativar o dispositivo, prima o botão para ativar/desativar Wi-Fi, ativar/desativar o LED, repor ou WPS.

Este equipamento cumpre os limites de exposição à radiação estabelecidos pela UE para um ambiente não controlado. Este equipamento deve ser instalado e utilizado a uma distância mínima de 20 cm entre o transmissor e o seu corpo.

Todos os modos operacionais:

2.4GHz: 802.11b, 802.11g, 802.11n (HT20), 802.11n (HT40), 802.11ac (VHT20), 802.11ac (VHT40)

5GHz: 802.11a, 802.11n (HT20), 802.11n (HT40), 802.11ac (VHT20), 802.11ac (VHT40), 802.11ac (VHT80)

A frequência, o modo e a potência máxima na UE são apresentados abaixo:

2412-2472MHz (802.11g 6Mbps): 19.81 dBm

5180-5240MHz (802.11ac VHT20 MCS0): 20.1 dBm

5260-5320MHz (802.11ac VHT40 MCS0): 21.31 dBm

5500-5700MHz (802.11ac VHT80 MCS0): 27.48 dBm

Este dispositivo está restrito a utilização no interior quando utilizado na banda de frequências 5.150 a 5.350 MHz.

O adaptador deverá ser instalado próximo do equipamento e estar facilmente acessível.

	AT	BE	BG	CZ	DK	EE	FR
	DE	IS	IE	IT	EL	ES	CY
	LV	LI	LT	LU	HU	MT	NL
	NO	PL	PT	RO	SI	SK	TR
	FI	SE	CH	HR	UK(NI)		

Safety Notices

- Utilize este equipamento em ambientes com temperaturas entre 0°C (32°F) e 40°C (104°F).
- Verifique a etiqueta relativa à tensão na parte inferior do seu dispositivo e assegure-se de que o seu transformador corresponde a essa tensão.
- NÃO coloque o computador em superfícies irregulares ou instáveis. Envie para reparação se a caixa se encontrar danificada.
- NÃO coloque nem deixe cair objetos em cima do aparelho e não introduza quaisquer objetos estranhos no produto.
- NÃO exponha o equipamento nem o utilize próximo de líquidos, chuva ou humidade. NÃO utilize o modem durante tempestades eléctricas.
- NÃO tape os orifícios de ventilação do produto para impedir o sobreaquecimento do sistema.
- NÃO utilize cabos de alimentação, acessórios ou outros periféricos danificados.
- Se a fonte de alimentação estiver avariada, não tente repará-la por si próprio. Contacte um técnico qualificado ou o seu revendedor.
- Para evitar o risco de choque eléctrico, desligue o cabo de alimentação da tomada eléctrica antes de deslocar o sistema.

Spanish CE statement

Declaración de conformidad simplificada para la UE

Por el presente documento, ASUSTek Computer Inc. declara que este dispositivo cumple con los requisitos esenciales y otras disposiciones pertinentes de la Directiva 2014/53/UE. En https://www.asus.com/Networking/ROG-Rapture-GT-AXE11000/HelpDesk_Declaration/ está disponible el texto completo de la declaración de conformidad para la UE.

Declaración de conformidad para la directiva de ecodiseño 2009/125/CE

Se han realizado pruebas para cumplir los requisitos de ecodiseño conforme a las directivas (CE) nº 1275/2008 y (UE) nº 801/2013. Cuando el dispositivo está en modo de espera y conectado en red, su interfaz de E/S y de red se encuentran en el modo de suspensión y pueden no funcionar correctamente. Para reactivar el dispositivo, presione el botón de activación y desactivación de la funcionalidad Wi-Fi, el botón de encendido y apagado de LED, el botón de restablecimiento o el botón WPS.

El equipo cumple los límites de exposición de radiación de la UE fijados para un entorno no controlado. Este equipo se debe instalar y utilizar a una distancia mínima de 20 cm entre el dispositivo radiante y su cuerpo.

Todos los modos operativos:

2.4GHz: 802.11b, 802.11g, 802.11n (HT20), 802.11n (HT40), 802.11ac (VHT20), 802.11ac (VHT40)

5GHz: 802.11a, 802.11n (HT20), 802.11n (HT40), 802.11ac (VHT20), 802.11ac (VHT40), 802.11ac (VHT80)

A continuación figuran la frecuencia, el modo y la potencia máxima de transmisión en la UE:

2412-2472MHz (802.11g 6Mbps): 19.81 dBm

5180-5240MHz (802.11ac VHT20 MCS0): 20.1 dBm

5260-5320MHz (802.11ac VHT40 MCS0): 21.31 dBm

5500-5700MHz (802.11ac VHT80 MCS0): 27.48 dBm

El dispositivo solamente debe utilizarse en interiores cuando opera en el intervalo de frecuencias de 5150 a 5350 MHz.

El adaptador debe estar instalado cerca del equipo y debe disponer de un acceso fácil.

	AT	BE	BG	CZ	DK	EE	FR
	DE	IS	IE	IT	EL	ES	CY
	LV	LI	LT	LU	HU	MT	NL
	NO	PL	PT	RO	SI	SK	TR
	FI	SE	CH	HR	UK(NI)		

Safety Notices

- Use este producto en entornos sometidos a una temperatura ambiente comprendida entre 0 °C (32 °F) y 40 °C (104 °F).
- Consulte la etiqueta de valores nominales situada en la parte inferior del producto y asegúrese de que su adaptador de alimentación cumple con dichos valores.
- NO coloque el equipo sobre una superficie irregular o inestable. Solicite asistencia técnica si la carcasa resulta dañada.
- NO coloque ni deje caer objetos en la parte superior del producto y no introduzca objetos extraños dentro de él.
- NO exponga el equipo a líquidos, lluvia o humedad, ni lo use cerca de ninguno de tales elementos. NO use el módem durante tormentas eléctricas.
- Para evitar que el sistema se sobrecaliente, no cubra las ranuras de ventilación del producto.
- NO cubra los orificios de ventilación del equipo de sobremesa para evitar que el sistema se caliente en exceso.
- No intente reparar la fuente de alimentación personalmente si se avería. Póngase en contacto con un técnico de mantenimiento autorizado o con su distribuidor.
- A fin de evitar posibles descargas eléctricas, desconecte el cable de alimentación de la toma de suministro eléctrico antes de cambiar la posición del sistema.

Swedish CE statement

Förenklad EU-försäkran om överensstämmelse

ASUSTek Computer Inc. deklarerar härmed att denna enhet uppfyller väsentliga krav och andra relevanta bestämmelser i direktiv 2014/53/EU. Hela texten i EU-försäkran om överensstämmelse finns på https://www.asus.com/Networking/ROG-Rapture-GT-AXE11000/HelpDesk_Declaration/.

Försäkran om överensstämmelse för Ecodesign-direktivet 2009/125/EC

Test för ekodesignkrav i enlighet med (EC) nr 1275/2008 och (EU) nr 801/2013 har utförts. När enheten är i standby-läge för nätverk, är gränssnitten för I/O och nätverk försatta i viloläge och fungerar kanske inte ordentligt. För att väcka enheten, tryck på knappen för att slå på/stänga av Wi-Fi, slå på/stänga av LED, återställa eller WPS-knappen.

Denna utrustning uppfyller EU:s strålningsexponeringsgräns för en okontrollerad miljö. Denna utrustning skall installeras och hanteras på minst 20 cm avstånd mellan strålkällan och din kropp.

Alla funktionslägen:

2.4GHz: 802.11b, 802.11g, 802.11n (HT20), 802.11n (HT40), 802.11ac (VHT20), 802.11ac (VHT40)

5GHz: 802.11a, 802.11n (HT20), 802.11n (HT40), 802.11ac (VHT20), 802.11ac (VHT40), 802.11ac (VHT80)

Frekvens, läge och maximalt överförd ström i EU anges nedan:

2412-2472MHz (802.11g 6Mbps): 19.81 dBm

5180-5240MHz (802.11ac VHT20 MCS0): 20.1 dBm

5260-5320MHz (802.11ac VHT40 MCS0): 21.31 dBm

5500-5700MHz (802.11ac VHT80 MCS0): 27.48 dBm

Enheten är begränsad till användning inomhus enbart vid användning inom 5 150 till 5 350 MHz frekvensområdet.

Adaptren ska installeras nära utrustningen och ska vara lätt att komma åt.

	AT	BE	BG	CZ	DK	EE	FR
	DE	IS	IE	IT	EL	ES	CY
	LV	LI	LT	LU	HU	MT	NL
	NO	PL	PT	RO	SI	SK	TR
	FI	SE	CH	HR	UK(NI)		

Safety Notices

- Använd denna produkt i en miljö med en omgivande temperatur mellan 0°C(32°F) och 40°C(104°F).
- Läs märketiketten på produktens undersida, och kontrollera att strömadaptren uppfyller dessa märkdata.
- Placera den INTE på en ojämn eller instabil arbetsyta. Sök service om höljat har skadats.
- Placera och tappa INTE föremål ovanpå, och skjut inte in främmande föremål i produkten.
- Utsätt den INTE för eller använd i närheten av vätskor, i regn eller fukt. ANVÄND INTE modemmet under åskväder.
- Täck INTE över ventilationsöppningarna på produkten för att förhindra att systemet överhettas.
- ANVÄND INTE skadade strömsladdar, tillbehör eller annan kringutrustning.
- Om strömförsörjningen avbryts försök inte att laga det själv. Kontakta en kvalificerad servicetekniker eller din återförsäljare.
- För att förhindra elektriska stötar, koppla bort elkabeln från elnätet innan systemet flyttas.

Service and Support

Visit our multi-language website at <https://www.asus.com/support>.

