

IdeaCentre Mini User Guide



Lenovo

Read this first

Before using this documentation and the product it supports, ensure that you read and understand the following:

- *Safety and Warranty Guide*
- *Generic Safety and Compliance Notices*
- *Setup Guide*

Second Edition (February 2024)

© Copyright Lenovo 2023, 2024.

LIMITED AND RESTRICTED RIGHTS NOTICE: If data or software is delivered pursuant to a General Services Administration "GSA" contract, use, reproduction, or disclosure is subject to restrictions set forth in Contract No. GS-35F-05925.

Contents

| | | | |
|--|-------------|---|-----------|
| About this documentation | .iii | CRU list | 11 |
| Chapter 1. Meet your computer | 1 | Remove or replace a CRU | 11 |
| Front | 1 | Power cord | 11 |
| Rear | 2 | Computer stand | 12 |
| Features and specifications | 3 | Computer cover | 14 |
| USB specifications | 3 | Bottom cover | 15 |
| Operating environment | 4 | Memory module | 17 |
| Chapter 2. Get started with your computer | 7 | Power supply assembly | 18 |
| Work with Windows | 7 | M.2 solid-state drive | 19 |
| Windows help information | 7 | System fan | 20 |
| Connect an external display | 8 | Chapter 5. Help and support | 23 |
| Chapter 3. Explore your computer | 9 | Frequently asked questions | 23 |
| Lenovo Vantage | 9 | Self-help resources | 23 |
| Set the power plan | 9 | Call Lenovo | 25 |
| Transfer data | 10 | Before you contact Lenovo | 25 |
| Connect to a Bluetooth-enabled device. | 10 | Lenovo Customer Support Center | 26 |
| Purchase accessories | 10 | Purchase additional services. | 26 |
| Chapter 4. CRU replacement | 11 | Appendix A. Notices and trademarks | 27 |

About this documentation

- This guide applies to the Lenovo product models listed below. Illustrations in this guide may look slightly different from your product model.

| Model name | Machine types (MT) |
|------------------------|--------------------|
| IdeaCentre Mini 01IRH8 | 90W2, 90W3 |

- For further compliance information, refer to the *Generic Safety and Compliance Notices* at https://pcsupport.lenovo.com/docs/generic_notices.
- Depending on the model, some optional accessories, features, and software programs might not be available on your computer.
- Depending on the version of the operating systems and programs, some user interface instructions might not be applicable to your computer.
- Documentation content is subject to change without notice. Lenovo makes constant improvements to the documentation of your computer, including this *User Guide*. To get the latest documentation, go to <https://pcsupport.lenovo.com>.
- Microsoft® makes periodic feature changes to the Windows® operating system through Windows Update. As a result, some information in this documentation might become outdated. Refer to Microsoft resources for the latest information.

Chapter 1. Meet your computer

Front

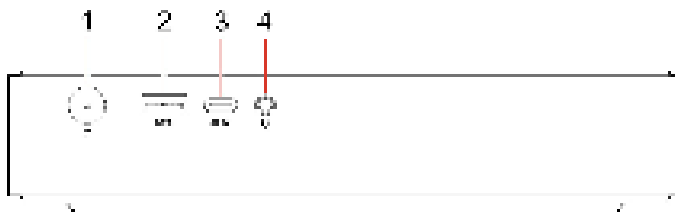

| Item | Description | Item | Description |
|------|------------------------------|------|-------------------------------------|
| 1 | Power button | 2 | Always On USB-A 3.2 Gen 2 connector |
| 3 | USB-C® (3.2 Gen 2) connector | 4 | Headset connector |

Power indicator

Show the system status of your computer.

- **On:** The computer is on.
- **Off:** The computer is off or in hibernation mode.
- **Blinking:** The computer is in standby mode.

Headset connector

The headset connector is compatible with:

- Headsets with a 3.5mm (0.14 inch), CTIA-compliant TRRS (4-pole) plug.

Note: This headset connector does not support standalone external microphones with a TRS (3-pole) plug or headsets with an OMTP-compliant TRRS (4-pole) plug.

Always On USB-A 3.2 Gen 2 connector

With the Always On USB feature enabled, the Always On USB 3.2 connector Gen 2 can charge a USB-compatible device when the computer is on, off, in sleep mode, or in hibernation mode.

Related topics

- “USB specifications” on page 3.

Rear

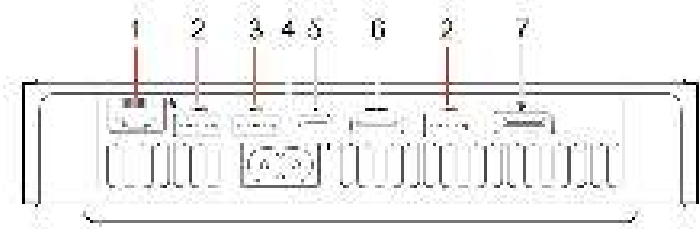

| Item | Description | Item | Description |
|------|----------------------------------|------|----------------------------|
| 1 | Ethernet connector | 2 | USB-A 3.2 Gen 2 connectors |
| 3 | USB-A 2.0 connector | 4 | Power cord connector |
| 5 | Thunderbolt™ 4 (USB-C) connector | 6 | HDMI™ 2.1 TMDs connector |
| 7 | DisplayPort™ 1.4 out connector | | |

Related topics

- “Connect an external display” on page 8.
- “USB specifications” on page 3.

Features and specifications

| Specifications | Descriptions |
|--------------------------------------|--|
| Hardware | To view the hardware information of your computer, type device manager in the Windows search box and then press Enter. |
| Power supply | <ul style="list-style-type: none">• 150-watt automatic voltage-sensing power supply |
| Adaptability for power supply | <ul style="list-style-type: none">• Mainland China: 220 V±22 V, 50 Hz±1 Hz• Adaptive voltage positioning: 100 V to 240 V, 50/60 Hz |
| Microprocessor | To view the microprocessor information of your computer, type system information in the Windows search box and then press Enter. |
| Memory | Up to two double data rate 4 (DDR4) small outline dual in-line memory modules (SODIMMs) |
| Storage device | <ul style="list-style-type: none">• M.2 solid-state drive <p>To view the storage drive capacity of your computer, type disk management in the Windows search box and then press Enter.</p> <p>Note: The storage drive capacity indicated by the system is less than the nominal capacity.</p> |
| Expansion | <ul style="list-style-type: none">• 2 Memory slots• 2 M.2 solid-state drive slots |
| Network features | <ul style="list-style-type: none">• Bluetooth• 2.5 G Ethernet LAN• Wireless LAN |



USB specifications

Note: Depending on the model, some USB connectors might not be available on your computer.

| Connector name | Description |
|----------------|-------------|
|----------------|-------------|





Connect USB-compatible devices, such as a USB keyboard, USB mouse, USB storage device, or USB printer.

-  USB-A 2.0 connector
-  USB-A 3.2 Gen 2 connector



- Charge USB-C compatible devices with the output voltage and current of 5 V and 3 A.
- Connect to an external display:
 - USB-C to VGA: 1920 x 1200 pixels, 60 Hz
 - USB-C to DP: 3840 x 2160 pixels, 60 Hz
- Connect to USB-C accessories to help expand your computer functionality. To purchase USB-C accessories, go to <https://www.lenovo.com/accessories>.

-  USB-C (3.2 Gen 2) connector
-  Thunderbolt 3 (USB-C) connector
-  Thunderbolt 4 (USB-C) connector

Statement on USB transfer rate

Depending on many factors such as the processing capability of the host and peripheral devices, file attributes, and other factors related to system configuration and operating environments, the actual transfer rate using the various USB connectors on this device will vary and will be slower than the data rate listed below for each corresponding device.

| USB device | Data rate (Gbit/s) |
|-----------------------|--------------------|
| 3.2 Gen 1 / 3.1 Gen 1 | 5 |
| 3.2 Gen 2 / 3.1 Gen 2 | 10 |
| 3.2 Gen 2 x 2 | 20 |
| Thunderbolt 3 (USB-C) | 40 |
| Thunderbolt 4 (USB-C) | 40 |

Operating environment

Temperature

- Operating: From 10°C (50°F) to 35°C (95°F)
- Storage or transportation: From -40°C (-40°F) to 60°C (140°F)

Relative humidity

- Operating: 20%-80% (non-condensing)
- Storage: 20%-90% (non-condensing)

Altitude

- Operating: -15.2 m (-50 ft) to 3048 m (10,000 ft)
- Storage: -15.2 m (-50 ft) to 10668 m (35,000 ft)

Chapter 2. Get started with your computer

Work with Windows

The following table contains Windows frequently used settings. You can learn the basics and start working with Windows right away.

To configure settings, type the corresponding keywords in the Windows search box and select the best match. Follow the on-screen instructions to customize settings.

Table 1. Basic settings

| Functions | Descriptions | Search by keywords |
|---------------------------|--|--------------------|
| Control Panel | View or change Windows settings, including hardware and software setup and configuration. | Control Panel |
| Connect to Wi-Fi networks | For models with a wireless LAN module, you can connect your computer to a Wi-Fi® network. Click the network icon in the Windows notification area, and then select a network for connection. Note: The wireless LAN module on your computer may support different standards. For some countries or regions, use of 802.11ax may be disabled according to local regulations. | Wi-Fi |
| Connect to wired networks | For models with an Ethernet (RJ45) connector, you can use an Ethernet cable to connect your computer to a wired network. | — |
| Airplane mode | Airplane mode is a convenient setting to turn all wireless communications of your computer on and off. You may need to turn it on when boarding an airplane. | Airplane mode |
| Night light mode | Night light is a switch in Windows that you can turn on and off. When it is turned on, your screen shows warmer colors and the amount of emitted blue light is reduced. Enabling night light reduces the chances of developing eye fatigue or eye strain. Note: For more guidance on reducing eye fatigue or eye strain, go to https://www.lenovo.com/us/en/compliance/visual-fatigue . | Night light |
| Adjust color temperature | If night light mode is turned on, you can adjust the color temperature of the screen. Note: Selected Lenovo computers are low blue light certified. These computers are tested with night light turned on and color temperature set to the default value of 48. | Night light |
| Windows Updates | Microsoft periodically releases feature and security updates to the Windows operating system. Updates that are applicable to your Windows version are downloaded automatically when your computer is connected to the Internet. When updates are downloaded, you are prompted to restart the computer to install these updates. You can also manually check if there are available updates for the installed version of Windows. Attention: Only use Windows Update to download and install updates. Updates downloaded from other sources may include security risks. | Windows Updates |

Windows help information

If the on-screen instructions cannot solve your problem, refer to the following to get the online Windows help information.

- Type Get Help or Tips in the Windows search box and then press Enter. When the app opens, type the problem description and select the matched result.
 - Visit Microsoft support Web site: <https://support.microsoft.com>. Enter what you are looking for in the search box and get search results.
-

Connect an external display

Connect a projector or a monitor to your computer to give presentations or expand your workspace.

Connect a wireless display

Ensure that both your computer and the wireless display support Miracast®.

Press the **Windows** and **K** Keys, and then select a wireless display to connect.

Change display settings

To change display settings, type display settings in the Windows search box and then press Enter.

Chapter 3. Explore your computer

Lenovo Vantage



The preinstalled Lenovo Vantage is a customized one-stop solution to help you maintain your computer with automated updates and fixes, configure hardware settings, and get personalized support.

Access Lenovo Vantage

Type Lenovo Vantage in the search box and then press Enter.

To download the latest version of Lenovo Vantage, go to Microsoft Store and search by the app name.

Key features

Lenovo Vantage enables you to:

- Know the device status easily and customize device settings.
- Download and install UEFI BIOS, firmware and driver updates to keep your computer up-to-date.
- Monitor your computer health, and secure your computer against outside threats.
- Scan your computer hardware and diagnose hardware problems.
- Look up warranty status (online).
- Access *User Guide* and helpful articles.

Notes:

- The available features vary depending on the computer model.
- Lenovo Vantage makes periodic updates of the features to keep improving your experience with your computer. The description of features might be different from that on your actual user interface.

Set the power plan

For ENERGY STAR® compliant computers, the following power plan takes effect when your computers have been idle for a specified duration:

- turn off the display: After 10 minutes
- put the computer to sleep: After 10 minutes

To awaken the computer from Sleep mode, press any key on your keyboard.

To change or customize a power plan:

1. Type power plan in the Windows search box and then press Enter.
2. Customize a power plan of your preference.

Transfer data

Quickly share your files using the built-in Bluetooth technology among devices with the same features. You also can install a disc or media card to transfer data.

Connect to a Bluetooth-enabled device

You can connect all types of Bluetooth-enabled devices to your computer, such as a keyboard, a mouse, a smartphone, or speakers. To ensure that the connection is successful, place the devices 10 meters (33 feet), at most, from the computer.



1. Click the action center icon in the Windows notification area. Enable the Bluetooth feature.
2. Click the bluetooth options to add a bluetooth device, and then follow the on-screen instructions.

Purchase accessories

Lenovo has a number of hardware accessories and upgrades to help expand the capabilities of your computer. Options include memory modules, storage devices, network cards, power adapters, keyboards, mice, and more.

To shop at Lenovo, go to <https://www.lenovo.com/accessories>.

Chapter 4. CRU replacement

Customer Replaceable Units (CRUs) are parts that can be replaced by the customer. Lenovo computers contain the following types of CRUs:

- **Self-service CRUs:** Refer to parts that can be replaced easily by customers themselves or by trained service technicians at an additional cost.
- **Optional-service CRUs:** Refer to parts that can be replaced by customers with a greater skill level. Trained service technicians can also provide service to replace the parts under the type of warranty designated for the customer's machine.

If you intend on installing the CRU, Lenovo will ship the CRU to you. CRU information and replacement instructions are shipped with your product and are available from Lenovo at any time upon request. You might be required to return the defective part that is replaced by the CRU. When return is required: (1) return instructions, a prepaid shipping label, and a container will be included with the replacement CRU; and (2) you might be charged for the replacement CRU if Lenovo does not receive the defective CRU within thirty (30) days of your receipt of the replacement CRU. For full details, see the Lenovo Limited Warranty documentation at:

https://www.lenovo.com/warranty/llw_02

CRU list

The following is the CRU list of your computer.

Self-service CRUs

- Computer stand*
- Power cord

Optional-service CRUs

- Bottom cover
- Computer cover
- M.2 solid-state drive
- Memory module
- Power supply assembly
- System fan

* for selected models

Remove or replace a CRU

This section provides instructions on how to remove or replace a CRU.

Power cord

Prerequisite

Before you start, read *Generic Safety and Compliance Notices*, and print the following instructions.

For access, do the following:

1. Turn off the computer and remove all connected devices and cables.
2. Disconnect the computer from ac power and all connected cables.

Removal procedure

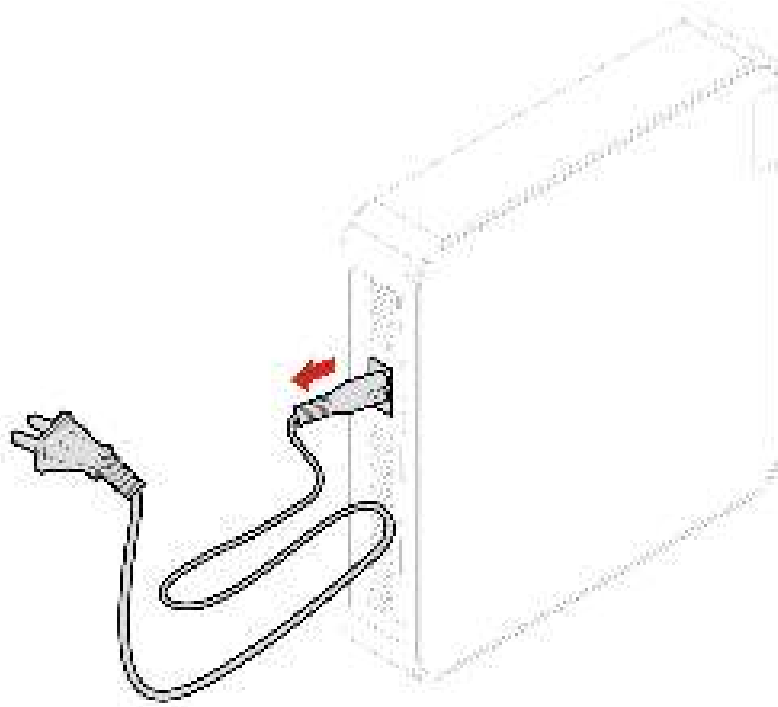

Computer stand

Prerequisite

Before you start, read *Generic Safety and Compliance Notices*, and print the following instructions.

For access, do the following:

1. Turn off the computer and remove all connected devices and cables.
2. Disconnect the computer from ac power and all connected cables.

Replacement procedure

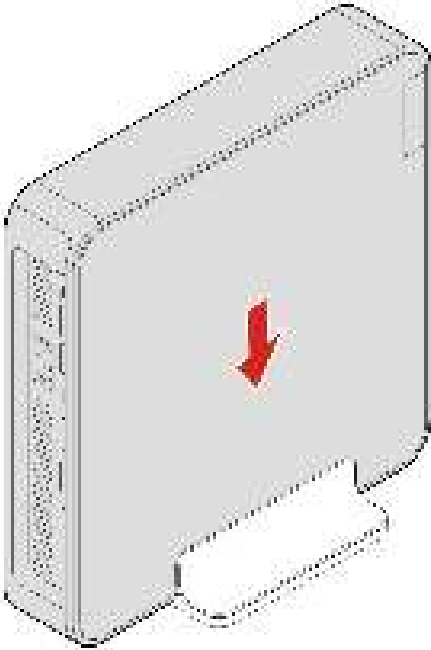
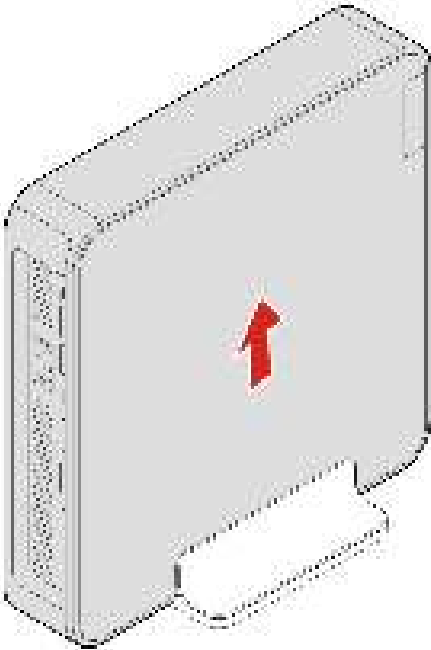

Computer cover

Prerequisite

Before you start, read *Generic Safety and Compliance Notices*, and print the following instructions.



Before you open the computer cover, turn off the computer and wait several minutes until the computer is cool.

For access, do the following:

1. Turn off the computer and remove all connected devices and cables.
2. Place a soft, clean towel or cloth on the desk or surface. Hold the sides of your computer and gently lay it down so that the computer cover is facing up.
3. Remove the computer stand. See “Computer stand” on page 12.

Removal procedure

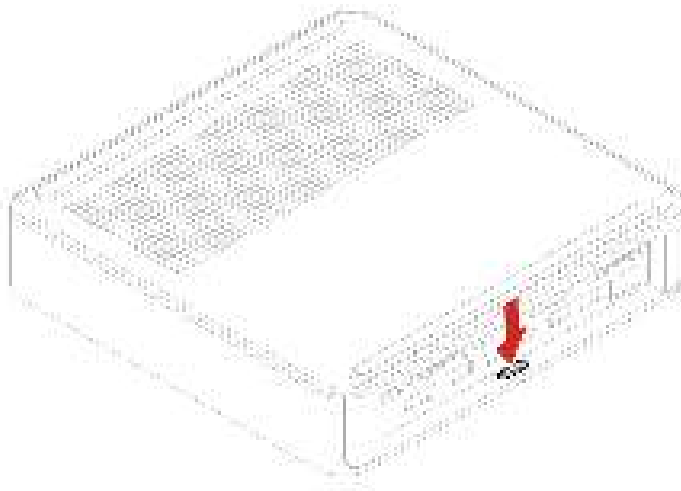

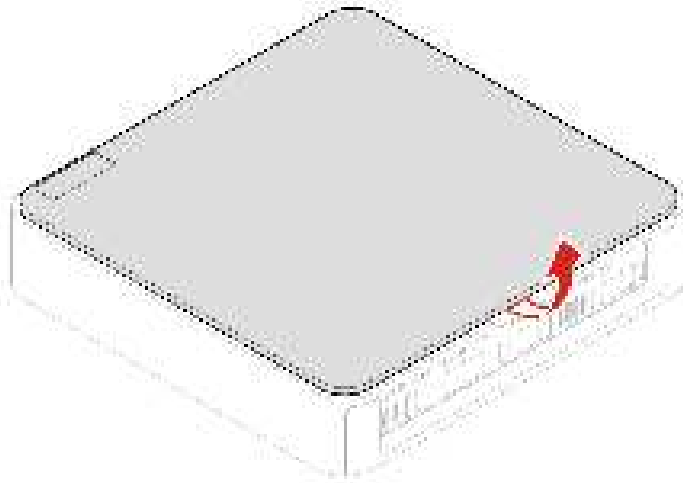

Bottom cover

Prerequisite

Before you start, read *Generic Safety and Compliance Notices*, and print the following instructions.



Before you open the computer cover, turn off the computer and wait several minutes until the computer is cool.

For access, do the following:

1. Turn off the computer and remove all connected devices and cables.
2. Place a soft, clean towel or cloth on the desk or surface. Hold the sides of your computer and gently lay it down so that the bottom cover is facing up.
3. Remove the computer stand. See “Computer stand” on page 12.
4. Remove the computer cover. See “Computer cover” on page 14.

Removal procedure

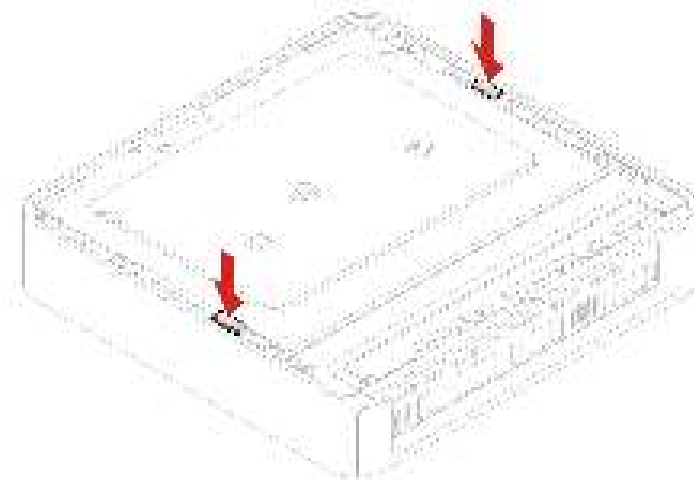
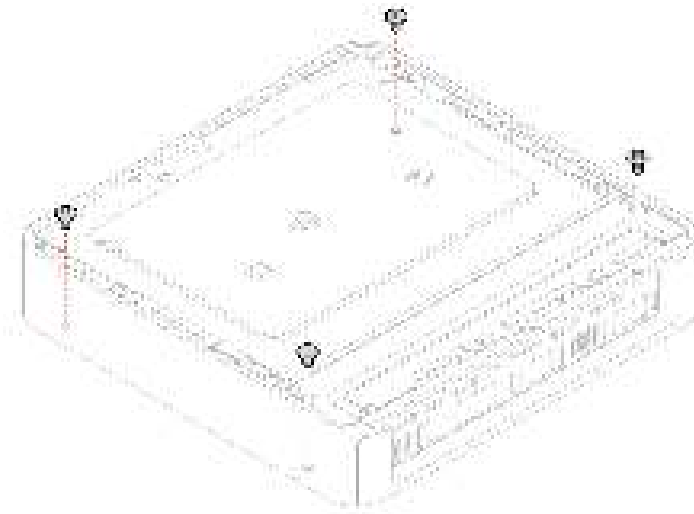

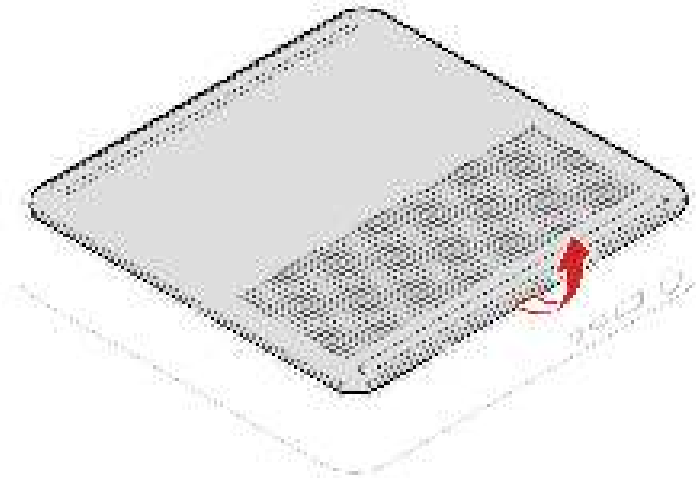

Memory module

Prerequisite

Before you start, read *Generic Safety and Compliance Notices*, and print the following instructions.

Ensure that you follow the installation order for memory modules shown in the following illustration.

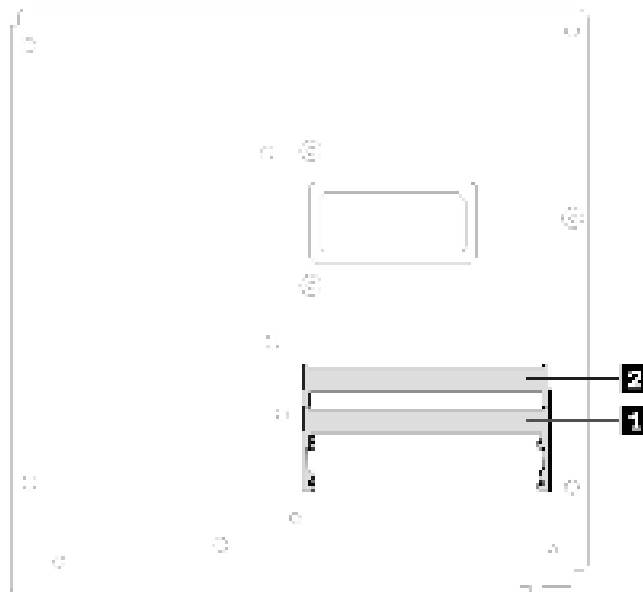

For access, remove the following parts in order:

- “Computer stand” on page 12

- “Computer cover” on page 14
- “Bottom cover” on page 15

Replacement procedure

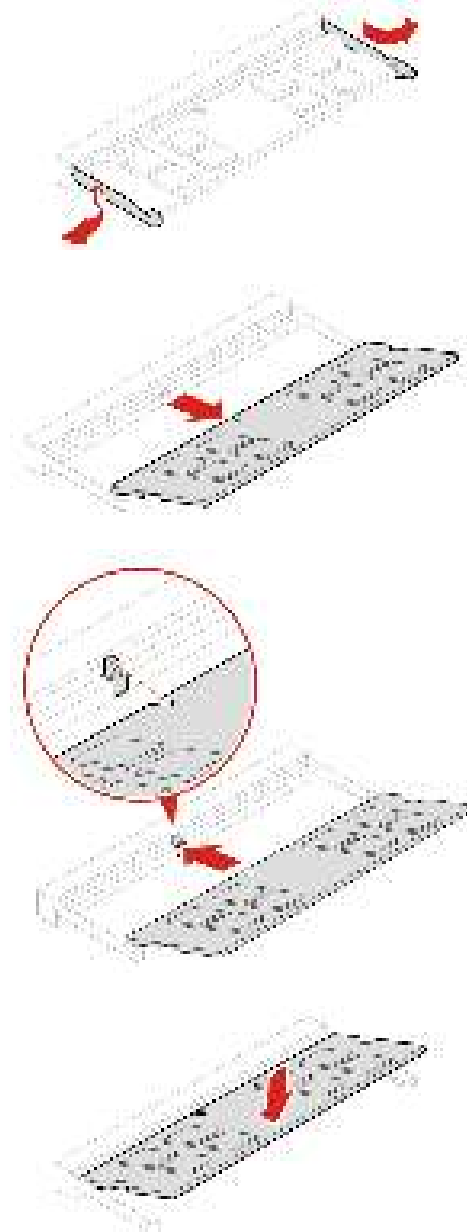

Power supply assembly

Prerequisite

Before you start, read *Generic Safety and Compliance Notices*, and print the following instructions.

Although there are no moving parts in the computer after the power cord has been disconnected, the following warnings are required for your safety.



Keep fingers and other parts of your body away from hazardous, moving parts. If you suffer an injury, seek medical care immediately. Never remove the cover on a power supply or any part that has the following label attached.

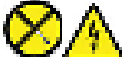

Hazardous voltage, current, and energy levels are present inside any component that has this label attached. There are no serviceable parts inside these components. If you suspect a problem with one of these parts, contact a service technician.

For access, do the following:

1. Remove the computer stand. See “Computer stand” on page 12.
2. Remove the computer cover. See “Computer cover” on page 14.
3. Disconnect the power supply assembly cables from the system board.

Removal procedure

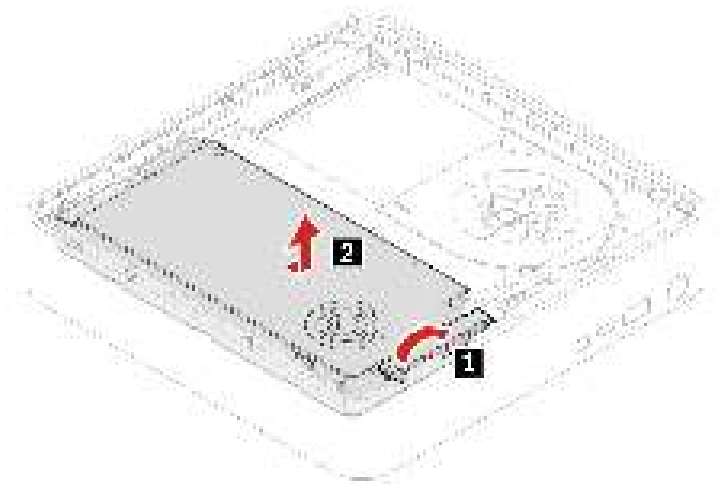

M.2 solid-state drive

Prerequisite

Before you start, read *Generic Safety and Compliance Notices*, and print the following instructions.



Before you open the computer cover, turn off the computer and wait several minutes until the computer is cool.

For access, remove the following parts in order:

- “Computer stand” on page 12

- “Computer cover” on page 14
- “Bottom cover” on page 15
- “Power supply assembly” on page 18

Replacement procedure

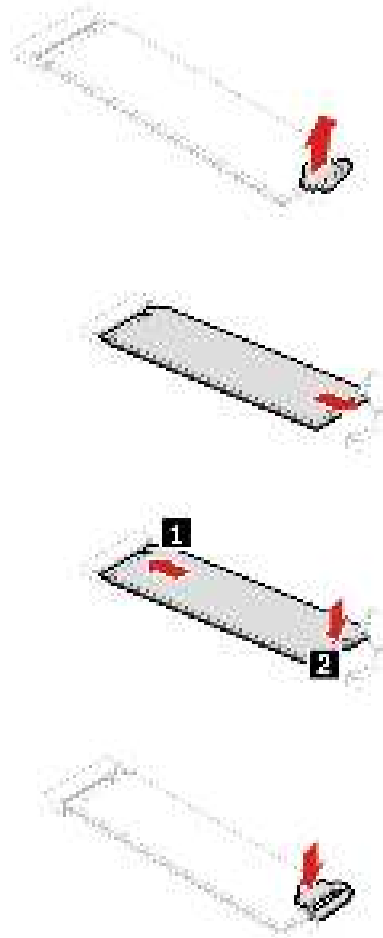

System fan

Prerequisite

Before you start, read *Generic Safety and Compliance Notices*, and print the following instructions.



Before you open the computer cover, turn off the computer and wait several minutes until the computer is cool.

For access, remove the following parts in order:

- “Computer stand” on page 12
- “Computer cover” on page 14
- “Bottom cover” on page 15

Removal procedure

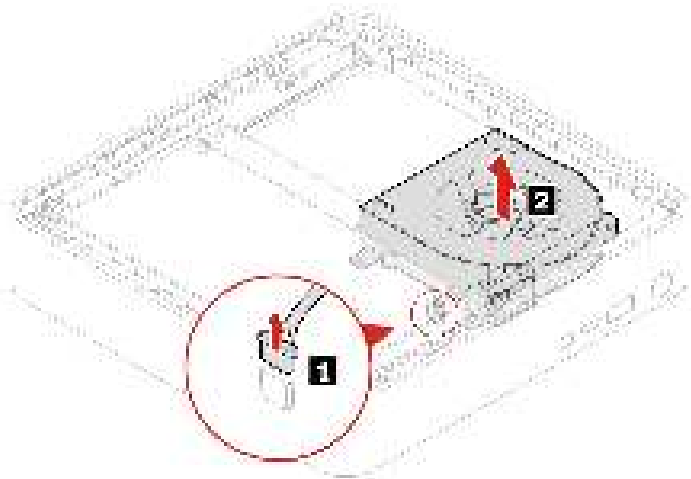

Chapter 5. Help and support

Frequently asked questions

| Questions | Solutions |
|--|--|
| How do I partition my storage drive? | Refer to https://support.lenovo.com/solutions/ht503851 |
| What should I do if my computer stops responding? | Press and hold the power button until the computer turns off. Then restart the computer. 1. Carefully unplug the ac power adapter and turn off the computer immediately. The more quickly you stop the current from passing through the computer the more likely you will reduce damage from short circuits. Attention: Although you might lose some data or work by turning off the computer immediately, leaving the computer on might make your computer unusable. |
| What should I do if I spill liquid on the computer? | 2. Wait until you are certain that all the liquid is dry before turning on your computer. CAUTION: Do not try to drain out the liquid by turning over the computer. If your computer has keyboard drainage holes on the bottom, the liquid will be drained out through the holes. |
| Where can I get the latest device drivers and UEFI/BIOS? | <ul style="list-style-type: none">• Lenovo Vantage or Lenovo PC Manager• Lenovo Support Web site at https://support.lenovo.com |

Self-help resources

Use the following self-help resources to learn more about the computer and troubleshoot problems.

| Resources | How to access? |
|--|--|
| Troubleshooting and frequently asked questions | <ul style="list-style-type: none">• https://www.lenovo.com/tips• https://forums.lenovo.com |
| Accessibility information | https://www.lenovo.com/accessibility |
| Reset or restore Windows | <ul style="list-style-type: none">• Use Lenovo recovery options.<ol style="list-style-type: none">1. Go to https://support.lenovo.com/HowToCreateLenovoRecovery.2. Follow the on-screen instructions.• Use Windows recovery options.<ol style="list-style-type: none">1. Go to https://pcsupport.lenovo.com.2. Detect your computer or manually select your computer model.3. Click Troubleshoot & Diagnose → Custom Troubleshooting → Operating System Diagnostics and then follow the on-screen instructions. |

| Resources | How to access? |
|---|---|
| <p>Use Lenovo Vantage to:</p> <ul style="list-style-type: none"> • Configure device settings. • Download and install UEFI BIOS, drivers and firmware updates. • Secure your computer from outside threats. • Diagnose hardware problems. • Check the computer warranty status. • Access <i>User Guide</i> and helpful articles. | <p>Type Lenovo Vantage in the search box and then press Enter.</p> |
| <p>Product documentation:</p> <ul style="list-style-type: none"> • Generic Safety and Compliance Notices • <i>Safety and Warranty Guide</i> • <i>Setup Guide</i> • This <i>User Guide</i> • <i>Regulatory Notice</i> | <p>Go to https://pcsupport.lenovo.com. Then, follow the on-screen instructions to filter out the documentation you want.</p> |
| <p>Lenovo Support Web site with the latest support information of the following:</p> <ul style="list-style-type: none"> • Drivers and software • Diagnostic solutions • Product and service warranty • Product and parts details • Knowledge base and frequently asked questions | <p>Go to https://support.lenovo.com.</p> |
| <p>Windows help information</p> | <ul style="list-style-type: none"> • Use Get Help or Tips. • Use Windows Search or the Cortana® personal assistant. • Go to Microsoft support Web site: https://support.microsoft.com. |

Lenovo Customer Support Center

During the warranty period, you can call Lenovo Customer Support Center for help.

Telephone numbers

For a list of the Lenovo Support phone numbers for your country or region, go to:
<https://pcsupport.lenovo.com/supportphonenumberlist>.

Note: Phone numbers are subject to change without notice. If the number for your country or region is not provided, contact your Lenovo reseller or Lenovo marketing representative.

Services available during the warranty period

- Problem determination - Trained personnel are available to assist you with determining if you have a hardware problem and deciding what action is necessary to fix the problem.
- Lenovo hardware repair - If the problem is determined to be caused by Lenovo hardware under warranty, trained service personnel are available to provide the applicable level of service.
- Engineering change management - Occasionally, there might be changes that are required after a product has been sold. Lenovo or your reseller, if authorized by Lenovo, will make selected Engineering Changes (ECs) that apply to your hardware available.

Services not covered

- Replacement or use of parts not manufactured for or by Lenovo or nonwarranted parts
- Identification of software problem sources
- Configuration of UEFI BIOS as part of an installation or upgrade
- Changes, modifications, or upgrades to device drivers
- Installation and maintenance of network operating systems (NOS)
- Installation and maintenance of programs

For the terms and conditions of the Lenovo Limited Warranty that apply to your Lenovo hardware product, see “Warranty information” in the *Safety and Warranty Guide* that comes with your computer.

Purchase additional services

During and after the warranty period, you can purchase additional services from Lenovo at <https://pcsupport.lenovo.com/warrantyupgrade>.

Service availability and service name might vary by country or region.

Appendix A. Notices and trademarks

Notices

Lenovo may not offer the products, services, or features discussed in this document in all countries. Consult your local Lenovo representative for information on the products and services currently available in your area. Any reference to a Lenovo product, program, or service is not intended to state or imply that only that Lenovo product, program, or service may be used. Any functionally equivalent product, program, or service that does not infringe any Lenovo intellectual property right may be used instead. However, it is the user's responsibility to evaluate and verify the operation of any other product, program, or service.

Lenovo may have patents or pending patent programs covering subject matter described in this document. The furnishing of this document does not give you any license to these patents. You can send license inquiries, in writing, to:

*Lenovo (United States), Inc.
8001 Development Drive
Morrisville, NC 27560
U.S.A.
Attention: Lenovo Director of Licensing*

LENOVO PROVIDES THIS PUBLICATION "AS IS" WITHOUT WARRANTY OF ANY KIND, EITHER EXPRESS OR IMPLIED, INCLUDING, BUT NOT LIMITED TO, THE IMPLIED WARRANTIES OF NON-INFRINGEMENT, MERCHANTABILITY OR FITNESS FOR A PARTICULAR PURPOSE. Some jurisdictions do not allow disclaimer of express or implied warranties in certain transactions, therefore, this statement may not apply to you.

Changes are made periodically to the information herein; these changes will be incorporated in new editions of the publication. To provide better service, Lenovo reserves the right to improve and/or modify the products and software programs described in the manuals included with your computer, and the content of the manual, at any time without additional notice.

The software interface and function and hardware configuration described in the manuals included with your computer might not match exactly the actual configuration of the computer that you purchase. For the configuration of the product, refer to the related contract (if any) or product packing list, or consult the distributor for the product sales. Lenovo may use or distribute any of the information you supply in any way it believes appropriate without incurring any obligation to you.

The products described in this document are not intended for use in implantation or other life support applications where malfunction may result in injury or death to persons. The information contained in this document does not affect or change Lenovo product specifications or warranties. Nothing in this document shall operate as an express or implied license or indemnity under the intellectual property rights of Lenovo or third parties. All information contained in this document was obtained in specific environments and is presented as an illustration. The result obtained in other operating environments may vary.

Lenovo may use or distribute any of the information you supply in any way it believes appropriate without incurring any obligation to you.

Any references in this publication to non-Lenovo Web sites are provided for convenience only and do not in any manner serve as an endorsement of those Web sites. The materials at those Web sites are not part of the materials for this Lenovo product, and use of those Web sites is at your own risk.

Any performance data contained herein was determined in a controlled environment. Therefore, the result obtained in other operating environments may vary significantly. Some measurements may have been made on development-level systems and there is no guarantee that these measurements will be the same on generally available systems. Furthermore, some measurements may have been estimated through extrapolation. Actual results may vary. Users of this document should verify the applicable data for their specific environment.

This document is copyrighted by Lenovo and is not covered by any open source license, including any Linux agreement(s) which may accompany software included with this product. Lenovo may update this document at any time without notice.

For the latest information or any questions or comments, contact or visit the Lenovo Web site:

<https://pcsupport.lenovo.com>

Trademarks

Lenovo, Lenovo logo, IdeaCentre, and IdeaCentre logo are trademarks of Lenovo. Intel and Thunderbolt are trademarks of Intel Corporation or its subsidiaries in the U.S. and/or other countries. Microsoft, Windows, and Cortana are trademarks of the Microsoft group of companies. DisplayPort is a trademark of the Video Electronics Standards Association. The terms HDMI and HDMI High-Definition Multimedia Interface, and the HDMI logo are trademarks or registered trademarks of HDMI Licensing Administrator, Inc. in the United States and other countries. Wi-Fi is a registered trademark of Wi-Fi Alliance. USB-C is a registered trademark of USB Implementers Forum. All other trademarks are the property of their respective owners. © 2022 Lenovo.

Lenovo