

htc®



User guide

Contents

Unboxing

VIVE Flow features	5
What's inside the box?	6
Connecting to a power source	6
Setting up VIVE Flow	7
Signing in with your HTC Account	8
Putting on VIVE Flow	9
Downloading free titles on VIVE Flow	9
Getting titles from VIVEPORT VR	10

Getting the most out of your VR glasses

About VIVE Flow	11
About the phone controller	12
Adjusting the diopter dial	15
Connecting to a Wi-Fi network	16
Changing boundary size	16
Turning on blue light filter	17
Changing preferred way to hold phone	17
Turning on Passenger mode	17
Mirroring your phone on VIVE Flow	18
Taking screenshots and screen recordings	20
Copying screenshots and screen recordings to your computer	20
Copying files from your computer to VIVE Flow	21
Playing videos from local storage	21
Casting your screen	22
Seeing real surroundings (Passthrough)	22
Pairing Bluetooth devices	23
Uninstalling content	23
Installing system and firmware updates	23
About cleaning and disinfecting VIVE Flow	24

VIVE app

What is the VIVE app?	26
What phones does the VIVE app support, and how do I get it?	26
What languages does the VIVE app support?	27
Managing phone notifications	27
Installing system and firmware updates from the VIVE app	27
Uninstalling the VIVE app	28

Common solutions

What phones can I use with VIVE Flow?	29
Why can't I see anything in front of me?	29
How can I optimize tracking in my space?	29
What can I do if the phone controller doesn't work?	29
What can I do if the phone controller is not responsive or lags?	31
Why can't VIVE Flow find my phone as a Wi-Fi hotspot?	31
What should I do when the phone controller disappears or doesn't work in VR?	32

What do I do if VIVE Flow suddenly loses power when using the phone controller as a power source?	33
What does the Headset button do?	33
What does the status light on VIVE Flow mean?	34
How do I pair my new phone to VIVE Flow or factory reset VIVE Flow?	34
Why can't I watch 360-degree YouTube videos in Phone mode?	35
How do I answer my phone when using VIVE Flow?	35
How do I enjoy VIVE Flow while lying down?	35
Why can't I open Google Assistant in Phone mode?	35
What should I do if I can't grant permission for Accessibility Services ?	36
My phone supports phone mirroring, why doesn't Phone mode work?	36
Why can't Miracast be detected on my HTC, Samsung, or Oppo phone?	37
Where do I find the VIVE app accessibility services setting on my Samsung phone?	37
What should I do if Phone mode crashes or doesn't work on my Xiaomi phone?	38
What should I do if I can't play back my video from my phone?	38
What should I do if I can't play back content from my OnePlus phone in Phone mode?	38
What do I do if my VIVE Flow isn't responding?	38
Why don't I see the "Special offers" popup when setting up VIVE Flow?	39
Why don't I see any gifted apps in my VIVE Flow?	39

Trademarks and copyrights

Index

About this guide

We use the following symbols to indicate useful and important information:



This is a note. It provides detailed information for setup, common questions, and what to do in specific situations.



This is a tip. It will give you an alternative way to do a particular step or procedure that you may find helpful.



This indicates important information that you need in order to accomplish a certain task or to get a feature to work properly.



This is a warning. Take note to avoid potential problems or prevent damage to your hardware.

Information contained in this guide may have changed. For the most up-to-date information, including the latest version of this guide, go to [VIVE Support](#).

Before using the product, carefully review VIVE safety information and follow all product safety and operating instructions on <https://www.vive.com/legal/>.

Unboxing

VIVE Flow features

Lightweight and comfortable

The easy-to-wear VR glasses made for wellness and mindful productivity. Compact and lightweight, VIVE Flow goes where you go.

Check out how to wear VIVE Flow in [Putting on VIVE Flow](#) on page 9.

Pair with your phone

VIVE Flow connects with your Android™ phone. Use your phone as a controller and get phone notifications while in VR.

- Check out [Setting up VIVE Flow](#) on page 7 to learn how to set up VIVE Flow and pair it with your phone.
- Learn how to interact in VR using your phone in [About the phone controller](#) on page 12.
- Go to [Managing phone notifications](#) on page 27 to learn how to set what notifications appear in VR.

Clear and warm view

VIVE Flow comes with adjustable diopter lenses so you can get a sharp and clear view. Using VIVE Flow close to bedtime is also not a problem with the blue light filter.

- Go to [Adjusting the diopter dial](#) on page 15 to learn how to adjust the dials.
- Learn how to turn on the blue light filter by going to [Turning on blue light filter](#) on page 17.

Phone mirroring

Mirror your phone on VIVE Flow to enjoy phone apps on your own personal large screen.

- Learn how to mirror your phone in VR by going to [Mirroring your phone on VIVE Flow](#) on page 18.
- Check the list of recommended phones for phone mirroring on <https://www.vive.com/vive-flow-phone-list/>.

VIVE app

Use the VIVE app to set up, configure Wi-Fi and language, perform system updates, and more for your VIVE Flow.

Learn more about the VIVE app in [What is the VIVE app?](#) on page 26.

What's inside the box?

Your VIVE Flow comes with the following items, which you'll use to experience immersive VR environments:

- VIVE Flow VR glasses
- Face cushion (attached)
- Nose rest (used only when adjusting the diopter dial)
- USB Type-C® cable
- Microfiber pouch

Connecting to a power source

VIVE Flow automatically turns on when plugged in to any power source such as a power bank.



Not all power banks or phones can provide enough power to VIVE Flow. VIVE Flow requires a power source that delivers at least 7.5W of power. If you see an "Insufficient power supply" message in VIVE Flow, connect the VR glasses to another power bank or to a power outlet using an AC adapter. There's no need to press the Headset or Volume buttons after connecting to a new power source.

1. Grab the USB Type-C cable from the box and connect one end to the USB Type-C receptacle cable on VIVE Flow.
2. Connect the other end of the cable to a power source such as a power bank, power outlet, or your phone.

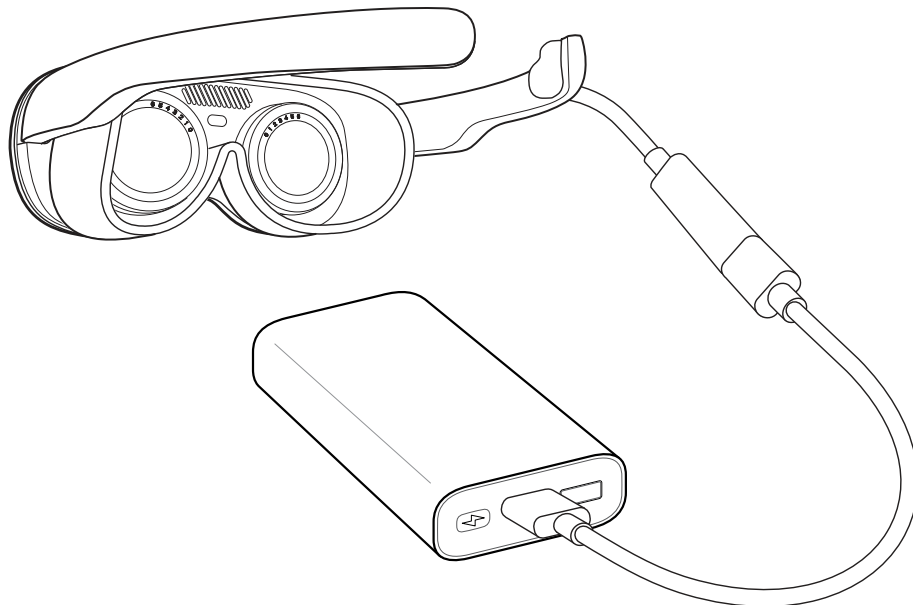

If connecting to a power bank, make sure to connect the USB Type-C cable to the output port of the power bank.

The LED indicator in front will light up when VIVE Flow turns on. After a few seconds, the LED indicator will turn off.



To turn off VIVE Flow, unplug it from the power source.

Setting up VIVE Flow

You'll need to use the VIVE app to set up VIVE Flow. You'll start setting up VIVE Flow on your phone and then finish setting up on the VR glasses.

1. On your Android phone, download and install the VIVE app. Get it from <https://vive.com/setup/flow> or search VIVE on the Google Play Store.
2. On your phone, open the VIVE app .
3. In the Welcome screen, tap **VIVE Flow**.
4. The app will walk you through in setting up the following:



5. Tap **Start**.
6. Follow the instructions on your phone and VR glasses to set up VIVE Flow. Some things to take note while setting up:
 - Keep both VIVE Flow and your phone nearby.
 - When the phone is trying to pair with VIVE Flow, it may take around 20 seconds or more for the phone to find VIVE Flow. Please be patient.
 - While pairing the phone to VIVE Flow, if the device name in VIVE Flow is different from the one on the phone, tap **Show more**. Look for your VIVE Flow in the list.
 - VIVE app needs phone permissions for you to enjoy the full features of the VR glasses. In the step where you're asked to grant permissions, after tapping **Grant** in each box, you'll be guided on what to turn on (i.e. VIVE). After granting permission, tap the back arrow until you get back to the VIVE app.
 - VIVE Flow can only connect to a Wi-Fi® network that supports Wi-Fi 802.11 a/ac/n (5 GHz band). Make sure your Wi-Fi router or phone's Wi-Fi hotspot is set to the 5 GHz band. To learn how to set your phone's Wi-Fi hotspot to 5 GHz, see [Why can't VIVE Flow find my phone as a Wi-Fi hotspot?](#) on page 31. To learn how to set your Wi-Fi router to the 5 GHz band, consult its user guide.
 - When going through the setup process in the VR glasses, take note of the position of the Headset button on VIVE Flow as you'll need to press it to go to the next step. See [About VIVE Flow](#) on page 11.



- If you have trouble pairing the VR glasses, make sure it's connected to a power source and near your phone.
- VIVE Flow can only pair with one phone at a time.

Signing in with your HTC Account

Sign in for the best experience and support. The best way to sign in is with the VIVE app, but you can also sign in while in VR.



If you don't have an HTC Account, we recommend creating one first on your computer. On your web browser, go to <http://www.viveport.com/>, and then click **Sign In** at the top-right corner.

1. From Home, select **Profile**.
2. Type your user name and password, and then select **Sign in**.

Putting on VIVE Flow

Open the frame of VIVE Flow, and then wear it as you would regular glasses.



- Before wearing VIVE Flow, connect it to a power source. See [Connecting to a power source](#) on page 6.
- If you wear glasses, remove them first before putting on VIVE Flow.
- It is strongly recommended to take regular breaks. Stop using VIVE Flow if you feel any discomfort.

If VIVE Flow keeps slipping down your nose while using it, adjust the fit of the face cushion. Remove the face cushion, and then squeeze the middle part of the face cushion, below the 2 plastic tabs, for a tighter fit.

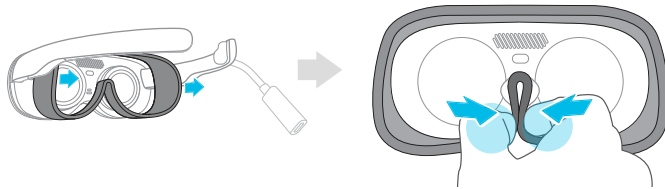

Do not squeeze the 2 plastic tabs as it may damage the face cushion.

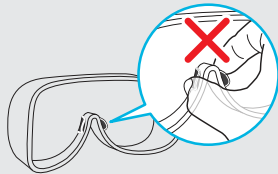

Downloading free titles on VIVE Flow

There may be some free titles available for download on your VIVE Flow.

1. To check if there are free titles, select **Library** from Home.
2. Select  > **Not Installed**.



3. Select a free title to download and install it.
4. To switch back to the installed titles in the VR Library, select  > **Installed**.

Getting titles from VIVEPORT VR

VIVEPORT™ VR offers a convenient way for users to access new titles and other content. Before purchasing, you can browse through titles in VIVEPORT VR from your VR glasses. Access VIVEPORT VR by selecting **Store** from Home.



Getting the most out of your VR glasses

About VIVE Flow

VIVE Flow is your window to the VR environment. The VIVE Flow cameras track the position of the VR glasses.

Front view

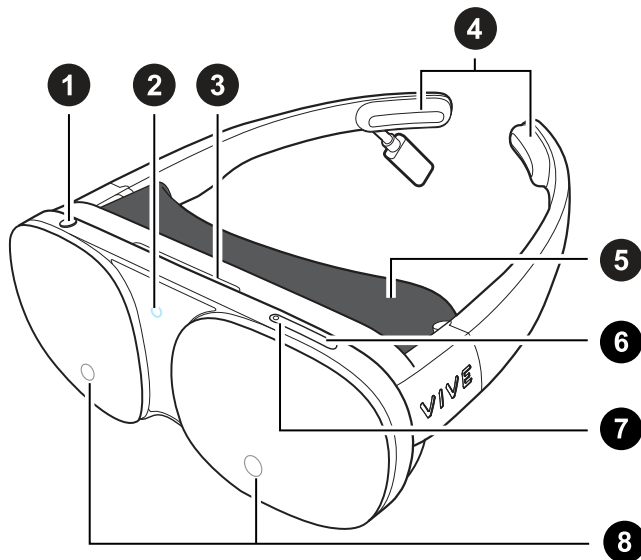

1. Headset button
2. LED (Status light)
3. Vent (Don't block or insert objects into it)
4. Temple pads (Removable)
5. Face cushion
6. Volume down button
7. Volume up button
8. Device cameras

Inside view

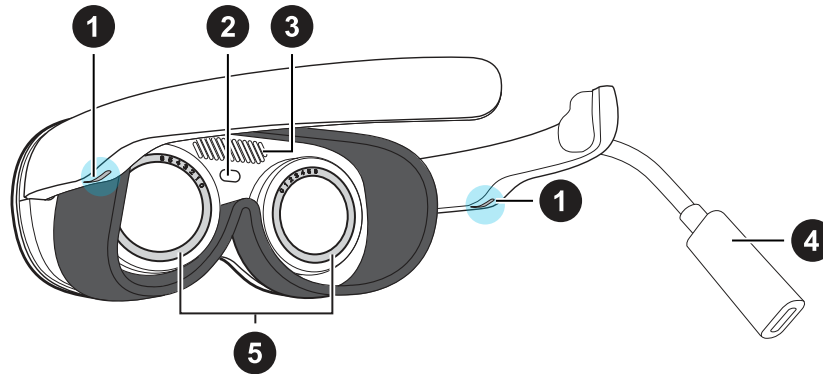

1. Speakers
2. Proximity sensor
3. Vent (Don't block or insert objects into it)
4. USB Type-C receptacle cable
5. Diopter dials

About the phone controller

Use your Android phone to interact in VR.



- You need to use the phone that you paired with your VIVE Flow, and make sure your phone and VIVE Flow are connected via Bluetooth®.
- Make sure the phone screen is unlocked.

Phone controller interface

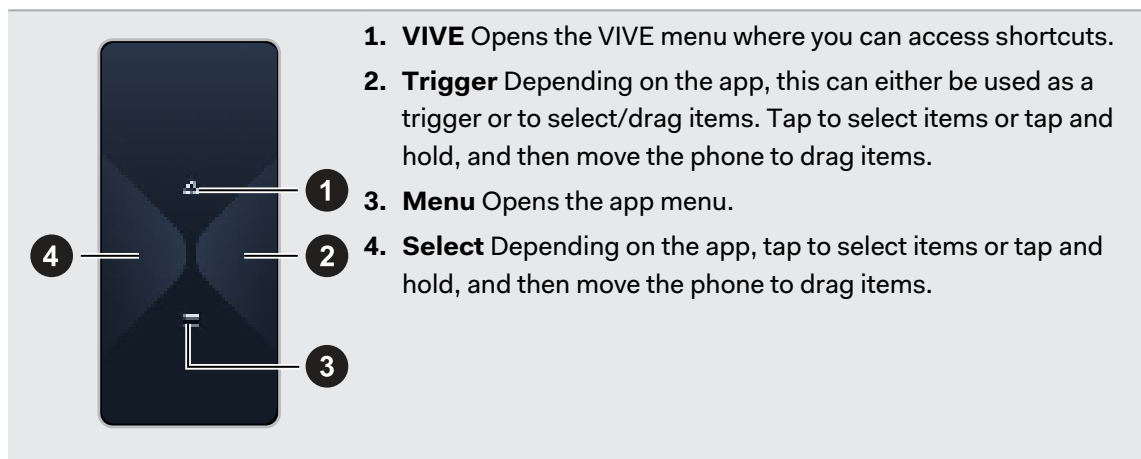



- In VR, look down on your hand holding the phone to see the controller layout. You can also see visual feedback when you tap the phone screen.
- To close the currently running app and go back to Home, open the VIVE menu, aim the beam on the Home image, and then select **Back to Home**.

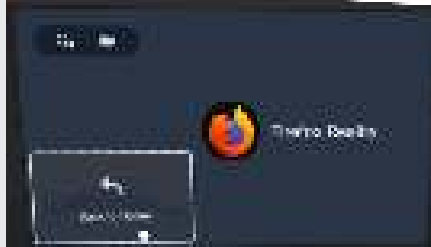

Touch gestures

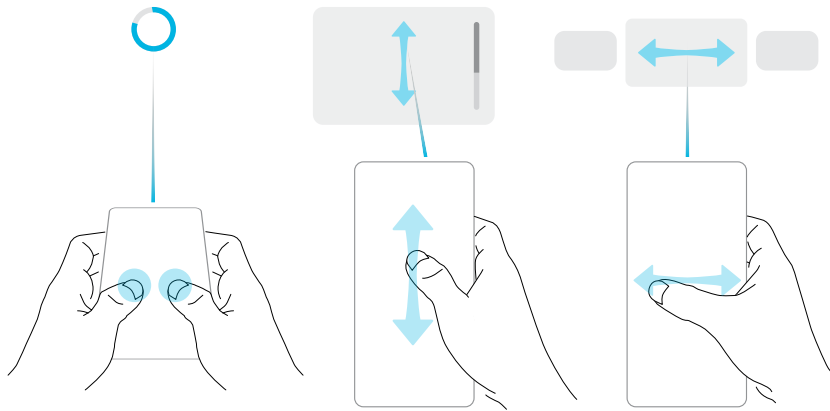

- Aim your phone forward and hold it parallel to the floor, and then tap and hold the screen with 2 fingers for 2 seconds to recenter the beam. Do this if the beam orientation is off or you can't see the beam in VR.
- Swipe vertically or horizontally to go through screens.

The phone controller is automatically disabled when you take off VIVE Flow. If you need to use your phone while using VIVE Flow, disable the phone controller by swiping down from the top of the phone screen. You need to disable the phone controller to use your phone.

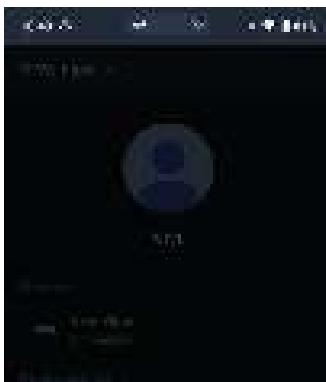



Your phone screen is dimmed when the phone controller is enabled.

To enable the controller again, swipe down to open the Notifications panel, and then tap **Phone controller disabled: Tap here to enable**.

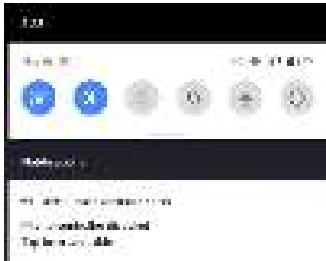

Adjusting the diopter dial

You can adjust the diopter dial even after setting up VIVE Flow. This is useful when sharing your VR glasses with friends or family so they can adjust it to get a clear and sharp view.

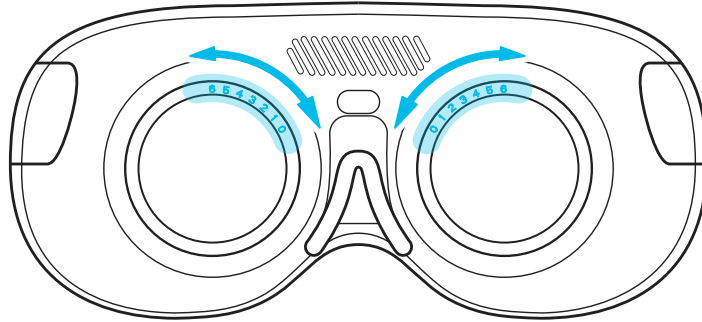

1. If you're currently running content, tap the **VIVE** button on the phone controller, and then select **Back to Home**.
2. Select **Library > Tutorial > Diopter adjustment**.
3. Follow the onscreen instructions to adjust the diopter dial to get a clear view.



Do not attach the face cushion when adjusting the diopter dial. You only need to attach the nose rest.

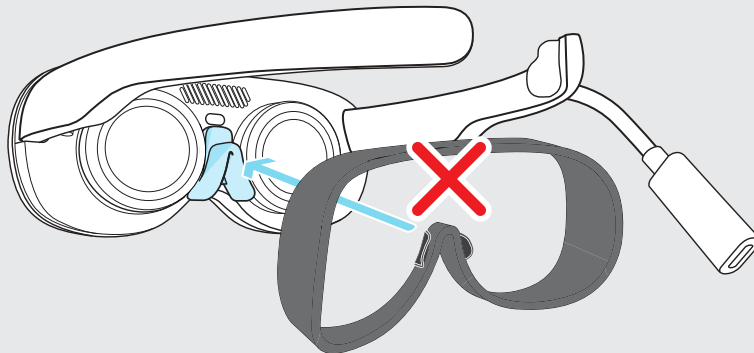

When you've finished the steps, you'll be taken back to Home.



Remember to remove the nose rest and re-attach the face cushion when you're done.

Connecting to a Wi-Fi network

It's easy to connect to Wi-Fi using the VIVE app or during the setup process, but you can also add or change networks from Settings.



VIVE Flow can only connect to a Wi-Fi network that supports Wi-Fi 802.11 a/ac/n (5 GHz band). Make sure your Wi-Fi router or phone's Wi-Fi hotspot is set to the 5 GHz band. To learn how to set your phone's Wi-Fi hotspot to 5 GHz, see [Why can't VIVE Flow find my phone as a Wi-Fi hotspot?](#) on page 31. To learn how to set your Wi-Fi router to the 5 GHz band, consult its user guide.

1. If you're currently running content, tap the **VIVE** button on the phone controller, and then select **Back to Home**.
2. From Home, select **Settings**.
3. In **Connectivity**, select **Wi-Fi**.
4. Choose a Wi-Fi network to add from the list. If your network is hidden, add it manually by selecting **Add Network** at the bottom of the list.
5. If this is the first time you've connected to this network, enter your network information.



- For some public Wi-Fi networks, such as the ones in hotels or airports, you'll need to open a web browser to log in to connect to the Wi-Fi network. In VR, open Firefox Reality, and then go to any website. Firefox Reality will redirect you to the log in page where you can enter the required credentials to connect.
- You can also use the VIVE app to set up Wi-Fi for VIVE Flow. In the VIVE app, tap your VIVE Flow under Headset, and then tap **Headset Wi-Fi**.

Changing boundary size

The boundary system automatically activates when you're close to the edge of your play area to help keep you safe. If you have a lot more open space for your play area, you can change the boundary size.

1. If you're currently running content, tap the **VIVE** button on the phone controller, and then select **Back to Home**.
2. From Home, select **Settings**.
3. In **Boundary**, select the size you want in Boundary size.

Turning on blue light filter

Reduce digital eye strain by filtering out blue light while using VIVE Flow. When using VIVE Flow at night, filtering out blue light may also help you sleep better.

1. If you're currently running content, tap the **VIVE** button on the phone controller, and then select **Back to Home**.
2. From Home, select **Settings**.
3. Select **General**, and then tap the Blue light filter **On/Off** switch to turn it on.
4. Drag the **Intensity** slider to the level you want.

Changing preferred way to hold phone

Changing the preferred way to hold your phone when using it as a controller in VR changes the angle of the beam emitted from the controller.

1. If you're currently running content, tap the **VIVE** button on the phone controller, and then select **Back to Home**.
2. From Home, select **Settings**.
3. In **Controller**, choose how you want to hold your phone.

Turning on Passenger mode

When using VIVE Flow in a moving vehicle or dark environment, turn on Passenger mode to prevent drifting.

1. If you're currently running content, tap the **VIVE** button on the phone controller, and then select **Back to Home**.
2. From Home, select **Settings**.
3. In **General**, tap the Passenger mode **On/Off** switch to turn it on.

You can also turn on or off Passenger mode by opening the VIVE app, tapping your VIVE Flow under Headset, and then tapping the Passenger mode **On/Off** switch.

Mirroring your phone on VIVE Flow

You can mirror what's on the phone screen inside VIVE Flow. Enjoy apps and watch your favorite shows on a personal large screen in VR.



Your phone needs to support Miracast™ in order to mirror your phone screen in VIVE Flow.

1. From Home, select **Phone** > **Let's go**.







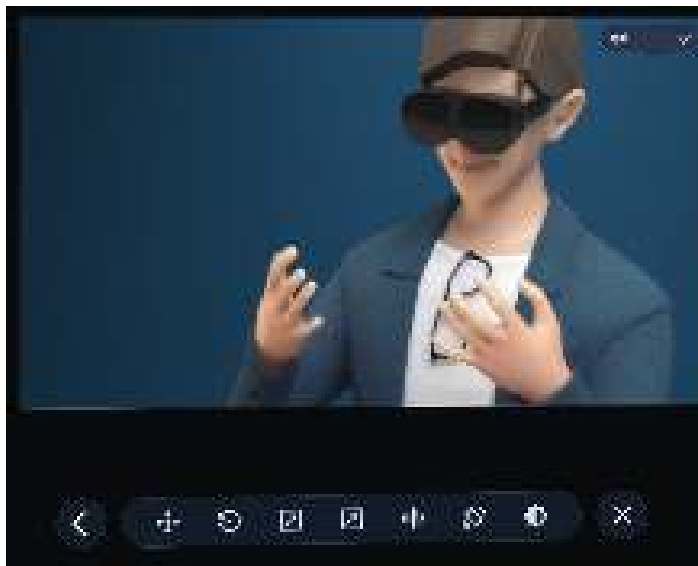



2. You can:

- Aim the beam on the phone screen to interact with your phone such as selecting an app to open it.
- Watch videos on your own personal large screen in VR.



- Use the toolbar to manage the phone mirroring experience.





-  Go back to the previous screen.
-  Reposition the phone screen in VR. Move the screen to its new position first before selecting **Done**. If you're lying down on your side, turn on **Sync with headset rotation** first before moving the screen.
-  Reset phone screen position and zoom level back to default settings.
-  Zoom in on the phone screen.
-  Zoom out of the phone screen.
-  Open your phone's voice assistant (e.g. Google Assistant™).
-  Switch the phone screen orientation to portrait or landscape.
-  Make the background lighter or darker.
-  Exit phone mirroring.



- If you don't see the toolbar, tap your phone screen or move your phone from side to side.
- Aim the beam at a button on the toolbar to see what it does.
- When you're using an app in full screen and in landscape orientation, tap  on the toolbar to exit full screen mode.
- Make sure the volume of your phone is not muted.

Taking screenshots and screen recordings

Screenshots and video recordings save VR moments for review or sharing. To take screenshots or video recordings:

1. On the phone controller, tap the **VIVE** button.
2. Do either of the following:
 - Select  to take a still screenshot.
 - Select  to record video from your VR screen and audio from your microphone.

VIVE Flow will quickly count down from 3, and then start your capture.

3. For screen recordings, you can stop the capture process by selecting **Stop recording**. If you've chosen video capture, your video capture will continue until you stop it or your VIVE Flow runs out of storage space.

Captures are stored on VIVE Flow.



- Take a quick screenshot by pressing the Headset and Volume down buttons.
- Take quick screen recordings by pressing the Headset and Volume up buttons. Press the same buttons again to stop recording.
- Screenshots and screen recordings may be disabled in some apps.

Copying screenshots and screen recordings to your computer

Copy your captured screenshots and screen recordings from VIVE Flow to your computer.

Here's how to copy files from VIVE Flow to a Windows® computer:

1. Connect one end of the USB Type-C cable to the USB receptacle cable on VIVE Flow and the other end to your computer.
2. Put on your VIVE Flow.
3. In the Choose USB mode dialog box, select **File transfer**.
4. Take off your VIVE Flow.
5. On your computer, open a file management app such as File Explorer, and then click **VIVE Flow**.
6. Click **Internal shared storage**. You'll find screenshots in **Pictures > Screenshots** and screen recordings in the **Movies** folder.

7. Open the folder you want to copy files from. Select the files, and then copy them to a folder in your computer.
8. When done, disconnect VIVE Flow from the computer.

To copy files from the VR glasses to a Mac computer, use a file transfer tool such as Android File Transfer. Go to android.com/filetransfer/ to download and learn how to use Android File Transfer.

Copying files from your computer to VIVE Flow

Copy files such as photos and videos from your computer to VIVE Flow.

Here's how to copy files from a Windows computer to VIVE Flow.

1. Connect one end of the USB Type-C cable to a USB port on your computer and the other end to VIVE Flow.
2. Put on your VIVE Flow.
3. In the Choose USB mode dialog box, select **File transfer**.
4. Take off your VIVE Flow.
5. On your computer, open a file management app such as File Explorer, and then open the folder you want to copy files from.
6. Select the files, and then copy them to a folder in **Internal shared storage** on VIVE Flow, which you can find in File Explorer.
7. When you're done, disconnect VIVE Flow from the computer.

To copy files from a Mac computer to VIVE Flow, use a file transfer tool such as Android File Transfer. Go to android.com/filetransfer/ to download and learn how to use Android File Transfer.

Playing videos from local storage

You can play videos from VIVE Flow local storage through **VIVEPORT Video**, which supports playback of standard (or flat), stereoscopic 3D, and 180- or 360-degree videos. Supported file formats include: .mp4, .mkv, .mov, and .divx.

The **VIVEPORT Video** app on VIVE Flow can be used to play videos from local storage. You can add videos to local storage manually by copying them from your computer to VIVE Flow. For details, see [Copying files from your computer to VIVE Flow](#) on page 21.

1. If you're currently running content, tap the **VIVE** button on the phone controller, and then select **Back to Home**.
2. From Home, go to the **Library** and launch **VIVEPORT Video**.



If you don't see **VIVEPORT Video** in the **Library**, you'll have to download and install it using the **VIVEPORT VR** app.

3. Select the folder that contains the video you want to play.
4. Point to the video you want to play and tap Trigger to open it.
5. While the video is playing, you can:
 - Play or pause the video using the playback controls.
 - Toggle the Mini Browser on or off.
 - Adjust the **Visual Settings** (below the playback controls) so you can watch the video in a 180- or 360-degree view, on a curved or flat display, and more.
 - Add subtitles by selecting **Select Audio and Subtitles** (the message icon with 3 dots) below the playback controls and choosing a subtitle file associated with the video.
 - Adjust general **Settings** such as autoplay and video looping.
 - Select **Move & Resize**, and then do either of the following:
 - **Move:** Tap and hold Trigger, then drag the screen around to reposition it.
 - **Resize:** Select the plus and minus buttons or drag the slider to adjust the zoom level.

Casting your screen

You can share what you see in VR with an external device wirelessly in real time. Your view in VR will appear on the device you choose, allowing you to share your VR experience, or watch the VR experiences of others.



VIVE Flow supports connecting to Miracast devices on the 5 GHz band.

1. On the phone controller, tap the **VIVE** button.
2. Select **Cast**.
3. Choose a device to cast to. If your device is not on the list, make sure your device is set to receive an incoming cast.



- Screen casting pauses automatically when you access certain kinds of personal information, such as password screens. Screen casting may also be disabled in some apps.
- Screen casting is not supported when in Phone mode. See [Mirroring your phone on VIVE Flow](#) on page 18.

Seeing real surroundings (Passthrough)

With the passthrough feature on VIVE Flow, you can see your real surroundings without taking the VR glasses off.

Press the Headset button twice to see your actual surroundings in black and white. To go back into VR, press the Headset button twice again.

Pairing Bluetooth devices

You can pair audio devices such as Bluetooth headphones or speakers with VIVE Flow. Here's how:

1. If you're currently running content, tap the **VIVE** button on the phone controller, and then select **Back to Home**.
2. From Home, select **Settings**.
3. Select **Connectivity > Bluetooth > Pair new device**.
4. Make sure that Bluetooth is on and that your other device is nearby and in pairing mode.
5. Select your device from the list.
6. If your device uses a PIN or code, type the PIN or verify the code.
7. Select **Pair** to pair your device.

Uninstalling content

Whether you want to free up space or no longer need it, it's easy to uninstall content.

1. If you're currently running content, tap the **VIVE** button on the phone controller, and then select **Back to Home**.
2. From Home, select **Settings**.
3. Select **Storage**.
4. Highlight your content on the list by pointing at it, and then select the **Trash** icon.



You can reinstall your content later.

Installing system and firmware updates

Keep your VIVE Flow system and firmware up-to-date with the latest features or enhancements. Your VR glasses will check for updates periodically, or you can check manually. Here's how:

1. If you're currently running content, tap the **VIVE** button on the phone controller, and then select **Back to Home**.
2. From Home, select **Settings**.

3. Under **General**, select **System update**.
4. Select **Update** to begin the update process.



- It is highly recommended to plug VIVE Flow to a power bank or power outlet using an AC adapter when doing system and firmware updates.
- Some updates may require restarting your VR glasses.
- You can also update the VR glasses through the VIVE app. See [Installing system and firmware updates from the VIVE app](#) on page 27.

About cleaning and disinfecting VIVE Flow

Keep VIVE Flow clean and hygienic with a few simple tips.

Do's

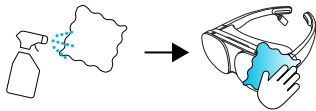

Dampen a cloth with a neutral and soft cleaner to wipe down the hard plastic of the VR glasses you touch most.

Don'ts

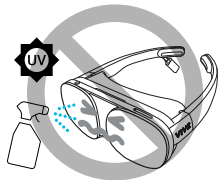

- Don't spray or pour liquid directly on your VR glasses.
- Don't use any liquids or cleaning solutions on the lenses.
- Don't expose your VR glasses to UV rays or direct sunlight.
- Don't use volatile solvent such as alcohol to wipe the temple pads.
- Don't wash the face cushion and temple pads.
- Don't machine wash.

Cleaning the VR glasses lenses

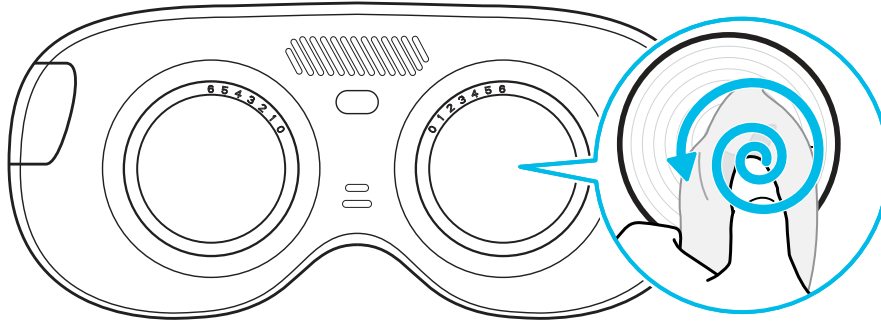

- Use a dry cleaning cloth to wipe the lenses, such as the microfiber pouch.
- Never use any kind of cleaning solution on the lenses.
- Wipe in a circular motion from the center to the outer edges of the lenses.

VIVE app

What is the VIVE app?

The VIVE app is an Android smartphone app that lets you set up and manage VIVE Flow. With the VIVE app, you can:

- Easily set up your VIVE Flow.
- Manage phone notifications in VR.
- Stay up to date with the latest releases.
- Perform a factory reset (hard reset) of VIVE Flow.

What phones does the VIVE app support, and how do I get it?

The VIVE app can be installed on Android phones with Android 9.0 or later.

You can download the app from:



- Your phone must be connected to Wi-Fi and have Bluetooth enabled to set up VIVE Flow.
- For a list of recommended phones to use with VIVE Flow, go to <https://www.vive.com/vive-flow-phone-list/>.

What languages does the VIVE app support?

The VIVE app language is set by your phone settings. If your phone language isn't supported, the VIVE app will choose another language from your region. If no language is available, it will default to English.

Managing phone notifications

Don't worry about missing important notifications while in VR. Manage which notifications you get while using VIVE Flow.

1. In VIVE app, tap **Notifications** under Phone service.
2. Choose the notifications you want to receive while in VR, and then tap the back arrow.
3. Tap the Notifications **On/Off** switch to turn it on or off.

Installing system and firmware updates from the VIVE app

Here's how to check for the latest system and firmware updates for your VR glasses and install them:

1. In the VIVE app, tap your VIVE Flow under Headset.
2. If you see that there's an available update, tap **System update > Update**.



It is highly recommended to plug VIVE Flow to a power bank or power outlet using an AC adapter when doing system and firmware updates.

Uninstalling the VIVE app

It's easy to uninstall the VIVE app from your Android phone.

1. From your phone's home screen, swipe down, and then tap **Settings**.
2. Depending on your phone's Android version, find and tap **Apps**, or tap **Apps and Notifications** > **All apps**.
3. Tap VIVE app, and then tap **Uninstall**.

Common solutions

What phones can I use with VIVE Flow?

Most Android phones can be used with VIVE Flow but we strongly recommend using a phone that supports Miracast and HDCP 2.2 and above. Having these features on the phone let you enjoy the full VIVE Flow experience. For a list of recommended phones, go to <https://www.vive.com/vive-flow-phone-list/>.

Why can't I see anything in front of me?

Sometimes when you take off VIVE Flow and then wear it again, your orientation is off and the screens in VR are not in front of you anymore. Reset the view to fix your orientation and positions of the screen.

1. On the phone controller, tap the **VIVE** button.
2. Select **More > Reset view**.
3. Follow the onscreen instructions to reset the view.

How can I optimize tracking in my space?

VIVE Flow uses inside-out tracking, relying on the unique appearance of your surroundings to orient the VR glasses and maintain your position in VR. Here are some tips to improve tracking in your space:

- Avoid direct intense light or glare, both on the VR glasses and in your space.
- Your space should be bright enough to read a book comfortably.
- Minimize reflective objects.
- Patterns on the walls, ceiling, and floor can help improve tracking. Try to minimize completely blank surfaces.
- Keep your play area clear of obstacles.

What can I do if the phone controller doesn't work?

Once paired, your phone should be automatically detected when connected to VIVE Flow.

- Make sure you are using the phone you paired with your VIVE Flow.
- Make sure Bluetooth on your phone is turned on and is connected to your VIVE Flow.

- Phone controller might be disabled on your phone. See [About the phone controller](#) on page 12.
- Make sure your phone has power.

What can I do if the phone controller is not responsive or lags?

If you're using an HTC U11 or HTC U11+ as your phone controller for VIVE Flow, turn off the **Location** setting on the phone. In Settings, tap **Location**, and then turn off the Use location **On/Off** switch.

Why can't VIVE Flow find my phone as a Wi-Fi hotspot?

It may be because the Wi-Fi hotspot band of your phone is set to 2.4 GHz. Check the table below to see how to change your phone's Wi-Fi hotspot band to 5 GHz.

Phone manufacturer	Wi-Fi hotspot 5 GHz setting path
ASUS™	<ol style="list-style-type: none"> 1. Go to Settings > Network & internet > Hotspot & tethering > Wi-Fi hotspot. 2. Tap AP Band > 5.0 GHz Band or Both.
HTC	<ol style="list-style-type: none"> 1. Go to Settings > Network & internet > Hotspot & tethering > Portable Wi-Fi hotspot or swipe down from the top of the screen to open the Notifications panel, and then tap and hold the Hotspot button. 2. Tap ⋮ > Advanced > Wi-Fi frequency band selection > 5GHz.
Huawei™	<ol style="list-style-type: none"> 1. Go to Settings > Mobile network > Personal hotspot > More. 2. Tap AP band > 5 GHz.
LG®	<ol style="list-style-type: none"> 1. Go to Settings > Network & internet > Tethering > Wi-Fi hotspot > Set up Wi-Fi hotspot > Show advanced options. 2. Under Broadcast channel, tap 5GHz.
OnePlus™	<ol style="list-style-type: none"> 1. Go to Settings > Wi-Fi & network > Hotspot & tethering > Wi-Fi hotspot. 2. Tap AP Band > 5.0 GHz Band.
Oppo™ or realme™	<ol style="list-style-type: none"> 1. Go to Settings > Connection & sharing > Personal hotspot > Personal hotspot settings. 2. Tap AP band > 5 GHz band.
Samsung®	<ol style="list-style-type: none"> 1. Go to Settings > Connections > Mobile Hotspot and Tethering > Mobile Hotspot > Configure. 2. Tap Band > 5 GHz preferred.
Sony™	<ol style="list-style-type: none"> 1. Go to Settings > Network & internet > Hotspot & tethering > Portable hotspot 2. Tap AP Band > 5.0 GHz Band preferred.

Phone manufacturer	Wi-Fi hotspot 5 GHz setting path
vivo	<ol style="list-style-type: none"> 1. Go to Settings > Other networks and connections > Personal Hotspot > Hotspot configuration. 2. Tap AP band > 5 GHz band.
Xiaomi™	<ol style="list-style-type: none"> 1. Go to Settings > Connection & sharing > Portable hotspot > Set up portable hotspot. 2. Tap Select AP Band > 5.0 GHz Band.

What should I do when the phone controller disappears or doesn't work in VR?

If the phone controller suddenly disappears, it may be for one of the following reasons:

- VIVE Flow got disconnected from your phone. Make sure the VR glasses and your phone are connected via Bluetooth.
- The VIVE app closed unexpectedly. Some phones automatically close apps when they detect that the app is running in the background. To resolve this, you'll need to change your phone's power management settings so the VIVE app can run uninterrupted in the background. The table below shows where the applicable power management setting is on some common phones. If you have trouble finding it, consult your phone's user guide.

Phone manufacturer	Power management setting path
ASUS	<ol style="list-style-type: none"> 1. Go to Settings > Apps & notifications > See all XX apps > VIVE > Battery > Battery optimization. 2. Select All apps from the drop-down, and then find and tap VIVE. 3. Select Don't optimize, and then tap Done.
Huawei	<ol style="list-style-type: none"> 1. Go to Settings > Battery > App launch. 2. Turn off the VIVE On/Off switch.
OnePlus	<ol style="list-style-type: none"> 1. Go to Settings > Battery > Battery optimization. 2. Tap VIVE, and then tap Don't optimize.
Oppo or realme	<ol style="list-style-type: none"> 1. Go to Settings > Battery > App battery management > VIVE and enable Allow background activity and Allow auto launch. 2. Go to Settings > Battery > More battery settings > Optimize battery use > VIVE and enable Don't optimize.
Samsung	<ol style="list-style-type: none"> 1. Go to Settings > Apps > VIVE > Battery. 2. Tap Optimize battery usage > Apps not optimized > All. 3. Search for VIVE, and then turn off the On/Off switch.

Phone manufacturer	Power management setting path
vivo	<ol style="list-style-type: none"> 1. Go to Settings > Battery > Background power consumption management. 2. Tap VIVE > Don't restrict background power usage.
Xiaomi	<ol style="list-style-type: none"> 1. Go to Settings > Battery & performance > Settings icon (upper-right corner) > App battery saver. 2. Tap VIVE > No restrictions.

What do I do if VIVE Flow suddenly loses power when using the phone controller as a power source?

VIVE Flow may suddenly lose power when using the phone controller as a power source if the **OTG connection** setting on the phone is enabled.

To prevent VIVE Flow from suddenly losing power when using the phone controller as a power source, make sure the **OTG connection** setting on the phone is disabled. To disable the **OTG connection** setting on Oppo or realme phones, go to **Settings > Additional settings**, and then disable **OTG connection**.

What does the Headset button do?

On the top-right side of the VR glasses, the Headset button allows you to control several basic functions.

Function	Headset button
Activate or deactivate passthrough (See your real surroundings in VR)	Double-click.
Select an item in Gaze mode.	Single click while looking at a menu item. When the phone controller is not found, you can look at menus and then press to select.
Open a menu where you can restart the VR glasses or enable/disable Passenger mode.	Press and hold for 2 seconds.
Force restart the VR glasses if it's unresponsive.	Press and hold for 12 seconds.

What does the status light on VIVE Flow mean?

The LED shows:

- Flashing white when VIVE Flow is booting up.
- Breathing white when VIVE Flow is on standby.
- Flashing orange when passthrough is turned on.
- Solid orange when the device temperature is higher than normal or performance is reduced. If this occurs, turn off your device and wait 30 minutes before turning it on again.

How do I pair my new phone to VIVE Flow or factory reset VIVE Flow?

You need to factory reset VIVE Flow to pair it with your new phone. Follow the steps below to factory reset VIVE Flow from the VIVE app.

1. Plug in VIVE Flow to a power source. See [Connecting to a power source](#) on page 6.
2. On your current phone that is paired with VIVE Flow, open the VIVE app.



Make sure your phone and VIVE Flow are connected through Bluetooth.

3. Under Headset, tap your VIVE Flow.
4. Tap **Reset headset**.
5. On your new phone, follow the steps in [Setting up VIVE Flow](#) on page 7 to set up VIVE Flow with your new phone.

If you lost your phone or deleted the VIVE app, you can still factory reset VIVE Flow by using the hardware buttons on VIVE Flow.

1. Plug in VIVE Flow to a power source. See [Connecting to a power source](#) on page 6.
2. Wear VIVE Flow, and then press and hold the Headset, Volume up, and Volume down buttons until you see the Reset headset window.
3. Look and hover on **Erase all data** until the button is selected.
4. Confirm that you want to do a factory reset.

Why can't I watch 360-degree YouTube videos in Phone mode?

When in Phone mode, VIVE Flow only mirrors what's shown on your phone screen. Use phone mode to watch standard videos and movies on your own personal big screen.

To watch 360-degree YouTube® videos, use the Firefox® Reality app in the VIVE Flow Library to go to the YouTube website. You can then search for 360-degree videos to watch.

If you have 360-degree videos you want to watch in VIVE Flow, you can use **VIVEPORT Video**. See [Playing videos from local storage](#) on page 21.

How do I answer my phone when using VIVE Flow?

If you have Calls in Phone notifications enabled, you'll see a notification in VR when there's an incoming call. See [Managing phone notifications](#) on page 27.



When you see an incoming call notification in VIVE Flow, take off VIVE Flow, and then use your phone to answer the call.



You may need to manually disable the phone controller to answer the incoming call. See [About the phone controller](#) on page 12.

How do I enjoy VIVE Flow while lying down?

You can still comfortably use Phone mode and Firefox Reality while you're lying down.

- **Phone mode:** Reposition the screen by using  on the toolbar. Before lying down, sit first on your sofa or bed, and then select . Then, as you lie down, drag the screen so it's in front of you when you're lying flat on your sofa or bed. See [Mirroring your phone on VIVE Flow](#) on page 18.
- **Firefox Reality:** Before lying down, sit first on your sofa or bed, and then open Firefox Reality. Lie down and then aim your phone forward towards your feet (not the ceiling) and parallel to the floor. Then, press and hold the screen with 2 fingers to automatically reposition the screen in front of you.

Why can't I open Google Assistant in Phone mode?

If Google Assistant™ doesn't open after selecting the Voice assistant button on the toolbar in Phone mode, it may be because Google Assistant didn't close after it was last used.

1. On your phone, swipe down from the top of the screen to disable the phone as controller.
2. Open the recent apps screen.
3. Find Google Assistant, and then swipe up to close it.

4. Open the notifications panel, and then enable the phone as controller. See [About the phone controller](#) on page 12.
5. Try opening Google Assistant again by selecting the Voice assistant button on the toolbar in Phone mode.

What should I do if I can't grant permission for Accessibility Services ?

Accessibility Services is needed in order to use your phone as a controller for VIVE Flow. If the **Grant** button in the permissions step when you're setting up VIVE Flow doesn't become  even if you've already granted permission, do this:

1. On your phone, go to Settings.
2. Search for `accessibility` and then tap it.



If multiple hits are found, tap the one that goes to the Accessibility page in the phone settings.

3. Tap **Vive**.
4. Tap the Use service **On/Off** switch to turn off, and then tap it again to turn it on.
5. Tap the back button until you get back to the VIVE app and check if permission is granted for Accessibility Service.

To learn more about setting up VIVE Flow, go to [Setting up VIVE Flow](#) on page 7.

My phone supports phone mirroring, why doesn't Phone mode work?

It may be because VIVE Flow cannot automatically connect to your phone. Follow the steps below to start mirroring your phone on VIVE Flow.

1. Take off VIVE Flow.
2. On your phone, go to Settings.
3. Search for Miracast.



Different phones have different names for Miracast (e.g. Cast or Smart View) or Miracast may not be in the phone settings. See [Where do I find the Miracast setting on my phone?](#) on page 37.

4. Tap **Vive_Flow_[Last 4 digits of Bluetooth address]**.
5. Wear VIVE Flow again.

To learn more about Phone mirroring, go to [Mirroring your phone on VIVE Flow](#) on page 18.

Where do I find the Miracast setting on my phone?

The table below shows where the Miracast setting is on some common phones. If you have trouble finding the Miracast setting on your phone, consult your phone's user guide.

Phone manufacturer	Miracast path
HTC	Go to Settings > Connected devices > Connection preferences > Cast .
Huawei	Go to Settings > Device connectivity > Wireless projection .
Huawei Mate 40	Go to Settings > More connections > Easy Projection > Wireless Projection .
LG	Go to Settings > Connected devices > Screen sharing .
realme	Go to Settings > Connection & sharing > Screencast .
Samsung	<ol style="list-style-type: none"> 1. Swipe down from the top of the screen to open the Notifications panel. 2. Tap Media > Smart View.
Sony	Go to Settings > Device connection > Connection preferences > Screen mirroring .
Xiaomi	Go to Settings > More (Under Wireless & Networks) > Wireless display .

Why can't Miracast be detected on my HTC, Samsung, or Oppo phone?

If your phone supports Miracast, you need to allow the VIVE app to access it. When setting up VIVE Flow, there is a step where the VIVE app checks if your phone supports Miracast. When it gets to this step, check for a message that pops up asking if you want to allow the VIVE app to access Miracast. Make sure to tap **Allow** on the message.

To learn more about setting up VIVE Flow, go to [Setting up VIVE Flow](#) on page 7.

Where do I find the VIVE app accessibility services setting on my Samsung phone?

In the permissions step when setting up VIVE Flow, you may need to manually grant permission for the VIVE app on your phone. Follow the steps below to grant Accessibility Services permission for the VIVE app.

1. In Accessibility Services, tap **Grant**. You'll be taken to the Accessibility page of the phone settings.
2. in Accessibility, tap **Installed services**.

3. Tap **Vive**, and then grant the VIVE app permission.
4. After granting permission, tap < at the top left corner until you get back to the VIVE app.

To learn more about setting up VIVE Flow, go to [Setting up VIVE Flow](#) on page 7.

What should I do if Phone mode crashes or doesn't work on my Xiaomi phone?

It may be because your phone doesn't allow the VIVE app to run in the background. Follow the steps below to grant the VIVE app permission to run in the background.

1. On your phone, go to Settings.
2. Under Apps, tap **Manage apps** > **VIVE**.
3. Under Permissions, tap **Other permissions**.
4. Under Settings, enable **Start in background**.

What should I do if I can't play back my video from my phone?

It may be because the content you're trying to play back has DRM-protection. Your phone needs to support HDCP 2.2 or later to be able to play back DRM-protected content on VIVE Flow. Check your phone manufacturer's website to see if your phone supports HDCP 2.2. To check a list of recommended phones to use with VIVE Flow, go to <https://www.vive.com/vive-flow-phone-list/>.

What should I do if I can't play back content from my OnePlus phone in Phone mode?

If you're using the OnePlus 8T, just restart your phone, and then try playing back the content again.

What do I do if my VIVE Flow isn't responding?

If your VIVE Flow is plugged in to a power source but isn't responding or needs to be restarted, you can manually restart it.



Manual restarts will cause all unsaved data to be lost.

Press and hold the Headset button for 12 seconds to perform a hardware restart.

If your VR glasses still won't respond, contact customer support.

Why don't I see the "Special offers" popup when setting up VIVE Flow?

If you don't see the "Special offers" popup when setting up your VIVE Flow, make sure you haven't previously logged in to the VIVE app to set up your VIVE Flow.

The "Special offers" popup only appears in the VIVE app the first time you set up your VIVE Flow. If you've previously logged in to the VIVE app to set up or use a different VIVE Flow, you won't see the Special offers screen.

If you see the "Special offers" popup while setting up your VIVE Flow, your promo code has automatically been applied to your HTC Account. You can visit <http://www.viveport.com/myredeem> to redeem your offer.

If you see the "Special offers" popup during setup, but your promo code doesn't automatically appear on <http://www.viveport.com/myredeem>, contact HTC support for assistance.

Why don't I see any gifted apps in my VIVE Flow?

If you've redeemed your promo code for your special offer but you don't see any of your gifted apps in the VIVE Flow **Library**, check the following:

- Make sure your VIVE Flow is up to date. You can check for system updates in **Settings > General**.
- Make sure your VIVE Flow is connected to Wi-Fi. Go to **Settings > Connectivity** to check your network settings
- Make sure you're logged in to VIVE Flow with the right account. You can check which account you're logged in with by selecting **Profile** from the lobby.

After you redeem your promo code, your gifted apps will be delivered directly to your VIVE Flow when you log in. However, after you redeem your promo code, it may take some time for the apps to appear in the **Library**. If you don't see any apps after redeeming your code, check the **Library** again after 24 hours. If you still don't see any of your gifted apps after 24 hours, contact HTC support for assistance.

Trademarks and copyrights

©2021 HTC Corporation. All Rights Reserved.

VIVE, the VIVE logo, HTC, the HTC logo, VIVEPORT, and all other HTC product and service names are trademarks and/or registered trademarks of HTC Corporation and its affiliates in the U.S. and other countries.

All other trademarks and service marks mentioned herein, including company names, product names, service names and logos, are the property of their respective owners and their use herein does not indicate an affiliation with, association with, or endorsement of or by HTC Corporation. Not all marks listed necessarily appear in this User Guide.

Screen images contained herein are simulated. HTC shall not be liable for technical or editorial errors or omissions contained herein, nor for incidental or consequential damages resulting from furnishing this material. The information is provided “as is” without warranty of any kind and is subject to change without notice. HTC also reserves the right to revise the content of this document at any time without prior notice.

No part of this document may be reproduced or transmitted in any form or by any means, electronic or mechanical, including photocopying, recording or storing in a retrieval system, or translated into any language in any form without prior written permission of HTC.

Index

Symbols

360 videos *35*

A

Adjusting diopter dial *15*

Adjusting face cushion/face gasket *9*

C

Capture screenshots and screen recordings *20*

Caring for your VIVE Flow *24*

Casting screen to another device *22*

Changing boundary size *16*

Cleaning your VIVE Flow *24*

Connecting to a power source *6*

Connecting to Wi-Fi network *16*

Copying files from computer to VIVE Flow *21*

Copying screenshots and recordings to computer *20*

D

Downloading free titles *9*

F

Factory reset *34*

First time setup *7*

H

Hardware

- about VIVE Flow *11*

- diopter dial *15*

- Inside the box *6*

- phone as controller *12*

HTC Account *8*

I

Inside the box *6*

M

Mirror your phone on VIVE Flow *18*

P

Pairing Bluetooth devices *23*

Passenger mode *17*

Passthrough *22*

Phone as controller *12*

Phone mirroring *18*

Phone mode *18*

Purchasing VR titles *10*

S

Screen capture *20*

Screen casting *22*

Screen recording *20*

Screenshots and recordings

- Capturing *20*

- Copying *20*

Seeing your real surroundings *22*

Setting up VIVE Flow *7*

Settings

- blue light filter *17*

- boundary size *16*

- passenger mode *17*

- preferred way to hold phone *17*

Supported phones *29*

T

Turning on blue light filter *17*

U

Uninstalling apps *23*

Updating firmware *23*

V

VIVE app

- about *26*

- installing updates *27*
- languages *27*
- phone notifications *27*
- supported phones *26*
- uninstalling *28*

VIVEPORT *10*

VR titles

- Free *9*
- Purchasing *10*

W

Wearing VIVE Flow *9*

Wi-Fi *16*